

AKG ACOUSTICS



WMS 40



WMS 400



WMS 4000

Wireless Microphone Systems

Everything you've always wanted to know
about AKG WIRELESS TECHNOLOGY.



WIRELESS TECHNOLOGY FOR THE FUTURE

A PIONEER IN ACOUSTICS FOR OVER 50 YEARS

As more and more affordable wireless equipment became available, the demand for high quality single and multi-channel wireless systems for sound companies, conference centers, public buildings, and live sound grew sharply, too. AKG responded to this trend early on,

developing a specific line of products and accessories that provides a professional solution for every application.

This brochure explains the way wireless systems work to provide a better understanding of how to make optimum use of

RF technology in day-to-day work. It contains many helpful tips and tricks for both professionals and first-time users. Wireless equipment from AKG will provide a professional solution for any application. This brochure makes it easier to get the best possible results.



“When it comes to studio, broadcast, or live sound equipment, choose AKG. The engineering competence and worldwide reputation of the AKG brand give you the confidence of using equipment meeting the highest standards of quality and reliability.”

Dr. Hugo Lenhard-Backhaus, CEO, AKG Vienna

AKG Facts & Figures:

- **Established in Austria in 1947**
- **Founders: Rudolf Görike and Ernst Pless**
- **AKG grew from a two-man company into a multinational company**
- **AKG has applied for more than 1,400 patents worldwide**
- **AKG is a leading audio manufacturer with one of the most advanced acoustics labs in Europe**

For more than five decades, AKG has been a leading manufacturer of studio microphones, broadcast and live sound equipment, as well as headphones to the highest standards of quality and reliability.

The resulting experience and engineering know-how are the foundation of the unique sound of AKG products as well as the

reputation and popularity of the legendary AKG brand. Today, AKG products are available throughout the world and have become a standard in many radio and TV studios.

Did you know that according to the 1990 Billboard Survey every US recording studio uses at least one AKG product?

Should you find no product for your specific application in this brochure, please post to the AKG Forum at www.akg.com.

We also appreciate any suggestions for improvements, new products, or other ideas you may post to our Microphone Forum.

AKG - A LEGENDARY BRAND

A PIONEER IN ACOUSTICS FOR OVER 50 YEARS

How it all started ...

A word to skeptics from the outset: the history of AKG is simply too good to have been just made up!

1945: In a setting reminiscent of "The Third Man", two men who had occasionally done business with one another before World War II met up again. They discovered that people sought distraction from the ruins around them at the movies, but that most of Vienna's movie theaters had either been bombed or plundered. Thus there was a pressing need for good theater equipment. And so it was that Rudolf Görike and Ernst Pless conceived a new idea: "Let us go into business together." This was the beginning of a success story that has already lasted over 50 years.

Rudolf Görike started manufacturing movie pro-

jectors and loudspeakers, whilst Ernst Pless delivered their growing customer base by bicycle and rucksack. As the volume of orders grew, they even resorted to using a good old-fashioned wheelbarrow! Their first customers did not have any hard currency to pay them with, but they did have pork, butter and cigarettes – fresh from the black market and in great demand.

1947: The two pioneers decided to set up a company. Once all the preparations had been made, the company set up office in a basement in a suburb of Vienna and hired a staff of five employees.

Initially the range included products such as exposure meters, car horns, intercom systems, carbon capsules and auxiliary handsets for telephones, pillow loudspeakers, and many other appliances that seem curious to us today. The

product range was continually adapted to meet demand.

Meanwhile Rudolf Görike, a gifted drawer and painter, created a logo for the company. It was he who designed the products, bubbling over with new ideas and applying for several patents in quick succession. Before World War II, he had been involved with microphones as development manager with the firm of "Henry Radio". His hobby remained his profession, and he was finally able to put his ideas for new technologies into practice.

The first AKG microphones went into service the same year, mainly with radio stations, at theaters, cabarets and jazz clubs. The AKG Dyn Series, for example, was one such development: painstakingly assembled by hand, it would be simply unaffordable today.



Die DYN Series

AKG developed its first dynamic microphones in 1946. With an annual production of 500 to 600 units, every single component was manufactured by hand and a wide variety of designs produced in the "DYN" series – DYN 60, DYN 60 G, DYN 60 K (see illustration), DYN 60 Studio, etc. The original microphones in this series have since become collectors' items.

K 120 DYN

The first AKG headphones bearing the designation K 120 DYN were launched in 1949. They were equipped with a Trolitul diaphragm of molded granulate, since foils were not yet available. At the time AKG had only one winding machine and one gluing machine.



The founders: Dr. Rudolf Görike and Ing. Ernst Pless

"The past is of no interest to me. I always look ahead – to the future..." commented AKG co-founder Rudolf Görike some years ago. At the time he was already over 80 years old!



The logo

The first AKG logo with three overlapping rings (symbolizing the typical omnidirectional polar pattern of the time) was designed by company founder Rudolf Görike. With the introduction of the AKG D 12 – the first microphone with a cardioid polar pattern – in 1953, the three rings were replaced with three cardioids. Apart from slight modifications, this logo has remained in use to this day, and is the guarantee of AKG's legendary quality the world over.

C 12

1953 marked the birth of another AKG legend: with the development of the C 12, AKG introduced its first large-diaphragm condenser microphone with a remote-controlled polar pattern. Initially produced in batches of 50 units a month, the C 12 quickly became a top international product, being adopted by nearly all leading radio stations and recording studios. The first customers included the BBC in London, where the microphone's design and quality made a deep impression.

C 12 A

1962 saw the introduction of the C 12 A Nuvistor condenser microphone, an enhanced version of the C 12. The Nuvistor miniature tube technology made it possible to design even smaller high-quality large-diaphragm microphones. At the same time, the distinctive shape of the C 12 A body was the forerunner of the classic C 414: even today the design of the C 414 is an internationally admired and patented three-dimensional trademark.

K 180

In 1969 AKG developed the K 180, the first set of headphones with SCS – "Subjective Controlled Sound": the sound could be varied by adjusting the speakers inside the earphones.

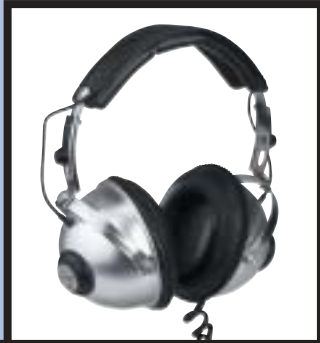

- 1945 Rudolf Görike and Ernst Pless start supplying Vienna movie theaters with equipment
- 1947 Rudolf Görike and Ernst Pless set up AKG
- 1953 World's first single-diaphragm dynamic cardioid microphone (D 12)
Manufacture of the famous C 12 large-diaphragm condenser microphone
Founding of a German subsidiary
- 1954 World's first single-diaphragm dynamic cardioid microphone
- 1955 World's first remote-controlled multipattern dynamic microphone (D 36)
- 1956 Professional cardioid microphone with variable rear sound entry to reduce proximity effect (D 24, D 19)
- 1959 World's first supra-aural headphones (K 50)
- 1960 Design of the first professional small-sized condenser microphone (C 60)
- 1965 Manufacture of movie theater equipment discontinued in favor of audio products
- 1966 World's first two-way cardioid microphones (D 202, D 224)
World's first wide-band ultrasonic transducer (CK 40)
- 1969 Founding of a British subsidiary
Design of the first modular condenser microphone (CMS system including C451, CK 1, etc.)
- 1970 World's first portable professional reverberator (BX 20)
- 1973 Her Majesty's Post Office issues a 3 p stamp to commemorate the BBC's 50th anniversary showing the BBC's standard microphones, all of them AKG models
- 1974 AKG applies for its thousandth patent
- 1975 Introduction of AKG multidaphragm headphones (K 240)
- 1976 Introduction of AKG TS System (Transversal Suspension) for phono cartridges (P8 ES etc.)
- 1977 Miniature studio condenser microphone with 6 mm capsule and self-polarized diaphragm
New compact reverberation unit (BX 5)
- 1978 World's first dynamic/electrostatic headphones (K 340)
- 1979 World's first modular digital time delay unit (TDU 7000)
Vocal microphones combining extreme ruggedness with studio-standard sound quality (D 300 Series)
Founding of a Japanese subsidiary
- 1981 Digital/analog reverberation unit (BX 25 ED)
- 1982 World's first compact dynamic/electrostatic headphones (K 4)
- 1983 New "digital-ready" modular condenser microphone system providing for capsule/preamp interface via cable up to 200 ft long (C 460 + CK 1X, CK 2 X)
- 1984 Stock exchange floatation of AKG Holding AG, which holds 75% of the shares of AKG Ges.m.b.H.
- 1985 Founding of a US subsidiary (March 1985)
- 1986 Acquisition of Ursa Major -> founding of the Digital Products Division of AKG Acoustics
Introduction of C 1000, the first condenser stage microphone with a convertible polar pattern and alternative phantom or 9 V battery power supply
- 1987 Introduction of the "K 280 Parabolic" headphones
Introduction of the DSP 610, a Delta Stereo Processor for setting up "Delta Stereophony" sound systems
- 1988 Introduction of the MicroMic Series
Founding of AKG Acoustics (India) Ltd.
- 1989 Introduction of the "CAP 340 M" Creative Audio Processor
Introduction of the DSE 7000 Digital Sound Editor
Introduction of the K 1000 headphones for binaural listening
Acquisition of Orban and dbx Professional Products
AKG Acoustics (India) Ltd. admitted to Indian stock exchange
- 1990 Development and manufacturing of IXT transducers for telephones
Development of a compact version of the CAP 340 M for "Audimir" space project
Merger of SCJ and AKG Japan
AKG acquires controlling interest in three UK companies: BSS Audio Ltd., Turbosound Ltd., Precision Devices Ltd.
- 1991 20% stake in CeoTronics/Germany, 30% stake in AMEK Technology Group PLC/UK, the holding company which owns AMEK Systems & Controls Ltd., and TAC Total Audio Concepts Ltd.
New product line of integrated handsets (IHA) for telephones
Founding of "AKG Communications France"
"Audimir" space project – first investigation of the basic mechanisms of acoustic orientation under zero-gravity conditions
Introduction of the WMS 900 and WMS 100 Wireless Microphone Systems
Introduction of the new "K Series" generation of headphones
Alliance with Lectrosonics/USA for sound reinforcement products
Alliance with Direct Research/Germany
- 1992 AKG acquires a 51% interest in its affiliate AKG Acoustics (India) Ltd.
AKG acquires majority stake (79%) in Edge Technology Group/UK (Turbosound, Precision Devices, BSS Audio)
Introduction of Tri-Power Series dynamic performance microphones
AKG Blue Line Series modular microphone system
C 547 boundary microphone
C 621, C 647 gooseneck microphones
Audiosphere BAP 1000 Binaural Audio Processor for Individual Virtual Acoustics launched in Germany and Austria
Presentation of new sound reinforcement equipment
MAP Modular Audio Processor and AS 100
Introduction of TMS II Digital Telephone Measurement System

The early products

In 1945 the company began supplying technical equipment such as movie projectors and loudspeakers to Vienna movie theaters. The PC 2535 G horn-loaded theater loudspeaker with a cardboard diaphragm, for instance, was manufactured in a living room.



The company name

The founders considered calling their company "Phonophot", but because of its similarity with another name, they opted for "Akustische- und Kino-Geräte", or AKG for short. Acoustic equipment became more and more predominant, and in 1965 theater equipment was dropped from the range entirely and the name changed to "AKG Acoustics".



AKG - A LEGENDARY BRAND

A PIONEER IN ACOUSTICS FOR OVER 50 YEARS

The breakthrough

At the beginning of the 1950s, the two ambitious founders of AKG achieved a breakthrough with completely revolutionary technologies. They applied for patents for their moving coil technology and the principle of the mass loaded diaphragm. For the first time, they were successful in extending the frequency response to the bass range. Whereas previous microphones had given a strange shrill, hollow sound similar to that in old talking motion pictures, AKG technology now added warmth and volume to the sound.

In 1953 the first dynamic microphone started its conquest of world markets: the D 12 took studios, broadcasting stations, movies, theaters, public speaking places, etc. by storm. It was followed by two successors, and for more than a decade set the standards for voice miking.

The first notable successes in the field of condenser microphones were achieved soon afterwards. The C 12 tube microphone set new standards in the professional sector.

AKG engineers used the CK 12 microphone capsule for the equally successful C 12A and the C 24, a stereo version. Even in the 21st century, the capsule is one of the foremost

innovations from AKG. The newest version – the C 12 VR – also won the Tec Award for the year 1995.

The K 10 set a new milestone in the headphone market. This AKG product is still on the market today, and is used at the European Parliament, for instance.

Expansion course

Dynamic microphones for tape recorders formed the cornerstone of AKG's German subsidiary, founded in 1955. Leading manufacturers of tape recorders such as Philips, Grundig, Uher, Loewe Opta, Nordmende, Telefunken and others all purchased their microphones from AKG. Since most of these customers were located in Germany, and it was difficult for AKG to supply them from an occupied Austria, some of the production facilities and the sales division were relocated, initially to Munich.

In the early years, AKG did not have its own sales network, using Siemens and other large companies as distribution partners. By the end of the 1950s, however, the company already had distribution partners in Europe and overseas. Thanks to Austria's neutrality, the company was also able to establish links with the

countries of the former East Bloc. It was only during the 1960s that AKG also started to build up contacts in the Far East and Latin America.

During the years that followed, AKG concentrated on studio products, and opened up a new market with portable reverb equipment.

By 1965 television had reduced the attraction of the big movie theaters so significantly that motion picture equipment was dropped from the production range entirely. From this time on, AKG engineers focused on their original strength: audio transducer technology.

Top products soon followed in all areas, like the dynamic two-way microphone, the modular condenser microphone system (CMS) and the K 141, which was ideally suited for both studio use and for hifi equipment. The C 414 set yet another standard in studio recording.

At the beginning of the 1970s, pickups were added to the consumer product line, where AKG achieved success with a series of top quality models until the advent of the compact disc superseded the record player. AKG subsequently withdrew from this market segment.

A new and exciting product line was found in transistorized telephone handset capsules,



Peter Wolf

With eight number one hits to his credit, Peter Wolf is one of the most successful Austrian composers and producers. Top acts he worked for include Jefferson Starship, The Commodores, Santana, The Scorpions, Frank Zappa, and many others.

Rock me Amadeus

Falco, Austria's most successful pop star to date – was a convinced and enthusiastic AKG user right from the beginning of his career. 1983 saw the relaunch of the legendary C 12 large-diaphragm tube microphone using the original 6072 tube – the "AKG Tube".



and these products rapidly became one of the mainstays of the company. AKG was also quick to introduce digital technology: the company made its debut at the 1980 Olympic Games in Moscow with the TDU 7000 time delay unit.

The turning point

1984 was a fateful year for AKG. The company went public on the Vienna Stock Exchange as a “blue chip”, and performed outstandingly for many years. At the same time, the owners of the company started to change, resulting in several different majority shareholders – major banks and private finance companies – in quick succession.

This went hand in hand with the company's new policy of expansion. The acquisition of other firms with complementary products was intended to help AKG achieve its goal of becoming an all-round supplier. The turning point

came with the great recession and the collapse of various currency parities: the leading banks changed their strategies of maintaining industrial holdings. At the beginning of the 1990s, AKG reported a loss for the first time in its history. In 1993 Harman International Inc. acquired a 76 percent stake in the AKG Group, buying up the remaining 24 percent the following year.

This also obliged AKG to fall back on its traditional strengths. Today microphones, headphones, industrial and telecommunications products make up the company's core business. The company's success has proved that this was the right decision for AKG.

In 1996 AKG entered wireless technology, an entirely new segment, introducing first the WMS 300 UHF multichannel system, followed by the WMS 800 and WMS 900 models. This technology was entirely revolutionary at the

time, and was eagerly taken up for stationary applications such as conference centers and theaters. This encouraged AKG to start rounding out the range in the year 1999 by developing a series of mobile UHF and VHF wireless systems called WMS 60 VHF, WMS 80 UHF, WMS 61 VHF, WMS 81 UHF, as well as the IVM 1, AKG's first in-ear monitoring system. The company also went on to develop wireless headphones, the youngest generation of which is also equipped with the latest Surround technologies.

In 2004, AKG products are available and popular all over the world. AKG Acoustics has become a leading manufacturer of audio products worldwide (more than 1,400 patents applied for). It is with good reason that countless professional and amateur users around the world rely on proverbial AKG quality.



WMS 300

In 1996 AKG launched the WMS 300, its first UHF wireless microphone system. This UHF multichannel system convinced the experts not only with its sound, but also its innovative modular design with interchangeable microphone elements and a wide selection of accessories.



CK 77

In 1995 AKG introduced the CK 77/C 577, the world's smallest dual-diaphragm microphone for theater, television and movie applications. This revolutionary dual-diaphragm technology made the microphone insensitive to impact noise, whilst the microphone's compact dimensions made it virtually invisible when worn with makeup or costumes. In combination with WMS wireless technology, the mic opened up an almost unlimited number of applications in any live situation.

New research center

In 2001 AKG opened a new acoustics research center with Europe's largest anechoic chamber (18 m3) at the company's headquarters in Vienna. This is where AKG continuously develops new patents, and manufactures most of its high-quality products – some of them still assembled by hand – for exportation to all parts of the world.



- 1993 Introduction of the “Tri-Power C Series”
Introduction of the “K Series” headphones
New AKG factory building completed
The entire factory, storage facilities, and all production departments move to the new premises
Harman becomes new majority owner of AKG Ges.m.b.H.
AKG Holding AG is delisted from the Vienna Stock Exchange
Hendrik Homan becomes new Managing Director of AKG Vienna
- 1994 AKG founder Rudolf Görike dies
Harman purchases the remaining shares to make AKG a 100%-owned Harman International company
AKG moves to new premises in Vienna-Siebenhirten
AKG Vienna assumes responsibility for Studer products in Austria
Cell manufacturing established at AKG
AKG expands its activities in the wireless market
- 1995 Introduction of the Performer Series, a range of affordable microphones for Karaoke, home recording and upcoming musicians
Introduction of the CK77, the smallest dual-diaphragm capsule in the world – big in sound, smaller than a thumbnail in size
New infrared headphones in “ergonomic” shape (K 444 IR, K 333 IR)
World's first surround sound headphones (K 290 Surround)
Introduction of IHA 90 integrated headset for computer communication
Endorsement by “Simply Red”
- 1996 Introduction of WMS 300 – a newly developed UHF wireless microphone system
Endorsers Simply Red on worldwide tour with AKG WMS 900
Introduction of Mini Elf and City Elf, extremely lightweight headsets
MicroMic Series II introduced
Invention of new VARIMOTION™ SYSTEM diaphragm technology
New range of high-quality headphones (K 501, K 401, K 301)
Introduction of K 205 UHF headphones
AKG nominated for European Design Award
- 1997 50th anniversary of AKG
Introduction of the SolidTube which makes the legendary AKG tube technology available at an attractive price!
AKG IVM 1 In-ear Monitor System using IVA Technology.
- 1998 The year of the Hearo 777: IVA technology for optimum surround sound experience
AKG WMS - multi-channel wireless microphone system
Modular Discreet Acoustics Series for Conferencing
Maximum mobility with the WLS 6060 MAX
Introduction of the CS 1 conference system
- 1999 Introduction of the C 4000 B the world's first dual large-diaphragm system
WMS 80, WMS 61, WMS 81 wireless microphone systems bring new sounds for a wireless world
Hearo 999 Audiosphere for the optimum surround sound listening experience
- 2000 C 3000 B receives M.I.P.A. 2000 (Musikmesse International Press Award)
WMS 40: UHF system combining professional quality and exceptional cost efficiency
Launch of C 4500 B-BC Broadcasting Condenser Microphone
- 2001 C 3000 B becomes reference for Roland COSM microphone modeling
HEARO 777: world's first headphones using Logic7 technology
C 451 B - new version of former C 451's
WMS 40 PT
MicroMic Series III, comprising four new models
- 2002 Introduction of the CS 2 Conference System
C 900 available as gold version and winner of the TEC Awards
Q 1000 Array Microphone für Mercedes
World Cup 2002 in Korea mit AKG

HOW WIRELESS TECHNOLOGY WORKS

HOW RADIO SIGNALS ARE TRANSMITTED

The case for wireless mics

The popularity of wireless systems is growing continuously, and they are no longer found only at open-air events, in theaters, and conference centers. The increasing selection of small portable wireless systems is the key to virtually unrestricted wireless freedom even for amateur musicians and low-budget users, opening up a huge diversity of applications.

The decisive factors behind the dramatic success of wireless systems are the easy handling and reliable, interference-free operation now offered by most of the medium-price wireless systems available on the market today. In practice, however, wireless technology is often unreasonably put down when minimal technical conditions are not met, usually by people who do not know any better.

The following section examines the principles of trouble-free wireless transmission and

gives an insight into what is technically possible, and how to achieve the best results.

Just like a radio set

At first it may sound simplistic to maintain that the operation of a wireless system is almost as simple as that of a radio set. However, in practice closer inspection shows that this comparison is entirely appropriate. Everybody knows that the reception quality of radio signals depends not only on the location of the receiver, but also on the quality of the transmitter, i.e. whether or not you are inside a building, and which transmission frequency is selected (FM 100.4, for instance). If the reception is poor, the first thing we do is to try and change the position of the receiver (the radio set). Then we try to change the position of the antenna, and if none of these remedies helps, we try to receive the desired radio station on another frequency (FM 94.7, for instance). This is a perfectly normal procedure, and no one would think of calling a radio set defective or unre-

liable, simply because each of us can operate a radio with our eyes shut.

Since reasonably priced, high-quality wireless microphone systems have only been available to the general public for a few years, it will probably take a while for people to become as familiar with this new technology. However, the comparison with a radio set is particularly appropriate and helpful for the technically uninitiated, since most people are able to operate radio sets correctly thanks to their intuition and experience.

Radio waves instead of cables!

With wireless technology, radio waves are used instead of a microphone cable to transmit a signal. For this purpose, we need a transmitter that transforms the audio input signal (voice, instrument, etc.) into a UHF or VHF signal and broadcasts it just like a miniature FM radio station. The receiver then transforms this high-frequency UHF or VHF signal back into an audio signal and ampli-

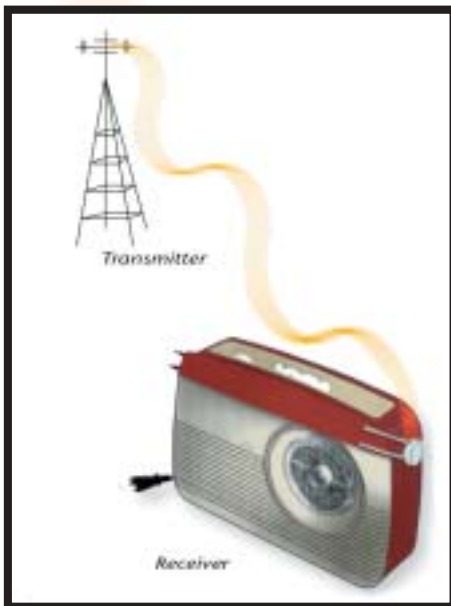

Transmitter/receiver

The situation with a transmitter and a receiver can be compared to the transmission of a signal between a radio station and a radio set. When we encounter problems with reception, we will either reposition the antenna, or look for the station on another frequency. The principles are exactly the same when it comes to a wireless microphone system. One of the most important rules is that you can only receive one station at a time with a radio, never several simultaneously.

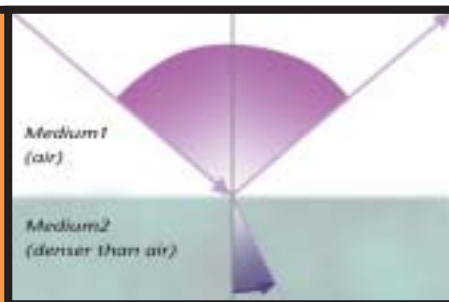

Reflection and scattering

Every wave has certain physical properties, and this also applies in the case of wireless transmission. When a wave travels from one medium to another, part of it is reflected and another part of it absorbed. Propagation of the absorbed part of the wave in the denser medium is considerably reduced, whilst the reflected part is returned at the same angle as the angle of incidence (diagram on left).

When a wave meets an irregular surface, it is not reflected uniformly and linearly, but is scattered in several partial waves, each deflected by a differing amount (diagram on right). The energy level of the wave naturally declines every time it is reflected, absorbed or scattered.

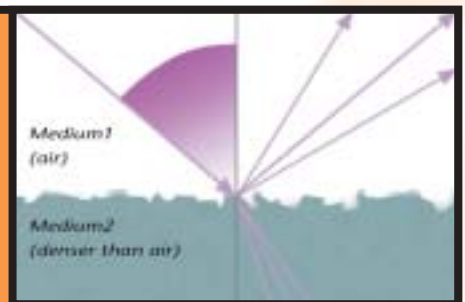

Shadowing

When a wave passes close to an obstacle, it is deflected slightly from its linear path. Thus a number of small obstacles in a room, such as wire screens, etc., can result in shadowing losses although visually they appear transparent.

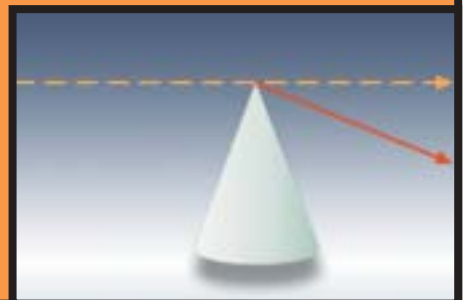

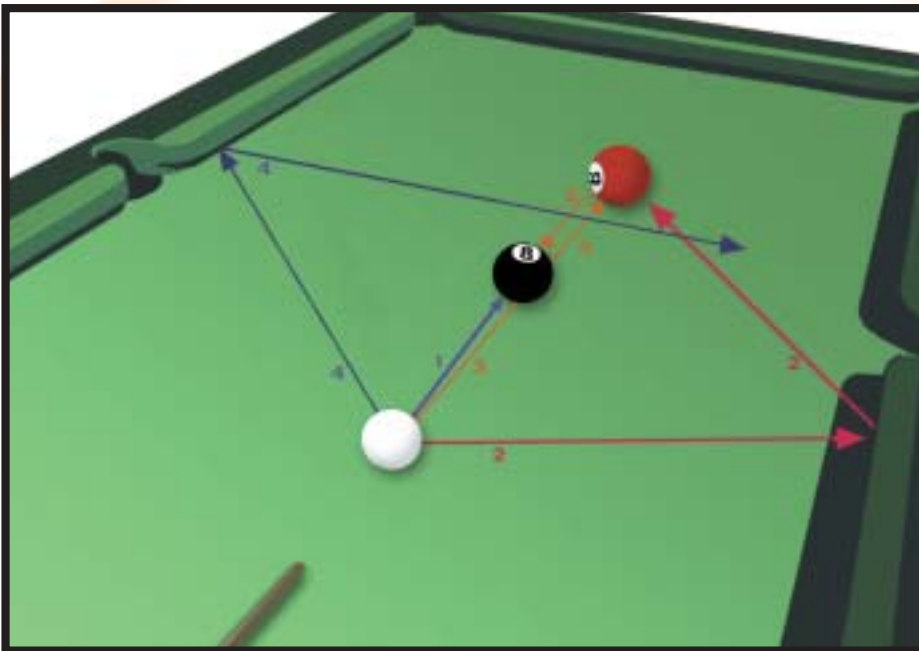

Signal propagation

As in a game of billiards, it is often impossible to reach a goal via a direct path. In the diagram on the left the red ball represents the receiver, the white ball the signal, and the black ball an obstacle between the two. However, in practice we are not dealing with a single ball, but with very many simultaneously. Thus there is a comparatively high probability that at least one of the balls will reach its goal.

1. The signal hits the obstacle directly and fails to reach its goal.
2. The signal reaches its goal after being reflected off the wall.
3. If two signals reach their goal simultaneously, they cancel each other out in a situation referred to as dropout.
4. In spite of being reflected, the signal fails to reach its goal, and continues to be propagated until its energy is expended.

fies it as necessary. An FM radio set – which everyone is familiar with – works on exactly the same principle.

Now that we have seen that a wireless microphone system functions just like an FM radio station on a narrow bandwidth, we can also see that it is subject to exactly the same physical laws that govern the propagation of radio waves. The challenge here is to find a technical solution to the typical phenomena of wave propagation, such as cancellation, heterodyning, and absorption. Other factors such as RF interference, electrical and electromagnetic fields, and intermodulation are also severely disruptive, and have a negative impact on the transmission quality of a wireless installation, significantly impairing the quality of the radio link and the audio signal. But more about that later!

It is particularly important to choose the right antenna and set up the antenna and receiver

correctly if we wish to avoid loss of quality. The rule of thumb is that the best radio transmission path is always the line of sight. Antennas and receivers should therefore never be hidden behind walls or other objects – it is vital to have a free line of sight between them! Problems with wireless systems during club gigs are frequently caused by incorrectly positioned antennas, although everything functioned perfectly during the sound check. In this case the audience forms an imaginary “wall” between the transmitter and the receiver, severely attenuating the radio signal. The best thing you can do is position the antenna high enough above the audience to avoid such a situation.

Do not place the antenna behind gratings, metal surfaces, or behind curtains if you can, as the signal will be unable to penetrate such obstacles. Even neon lights, dimmers, lighting systems, electronic equipment with strong RF radiation, like computers and stage

effects, power switching equipment, keyboards, etc. are potential sources of interference. They produce high-frequency harmonics, and are therefore totally unsuitable for use near the antennas of wireless systems. The minimum distance between walls and antennas should not be less than 3 feet, and the recommended minimum distance between transmitter and receiver is 10 feet.

You can get even better results by using diversity systems, carefully selecting the carrier frequency band (UHF or VHF), and placing the antenna(s) carefully to prevent any dead spots. If none of the above methods alone improves the situation, try them in different combinations. If this still does not help, you should secretly check that the receiver is connected to power, and that fresh batteries have been inserted in the transmitter! But seriously, even professionals have made this mistake in the commotion of setting up the equipment for a gig!

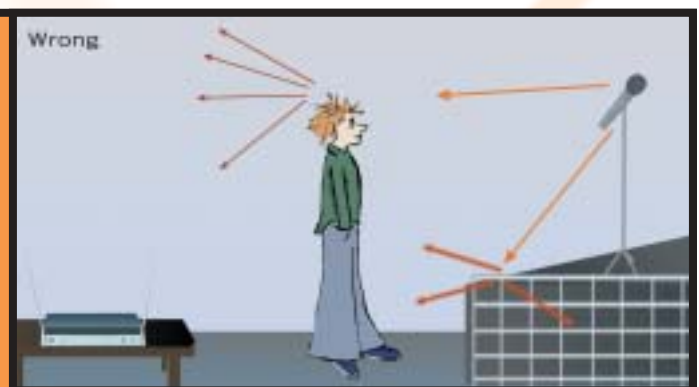
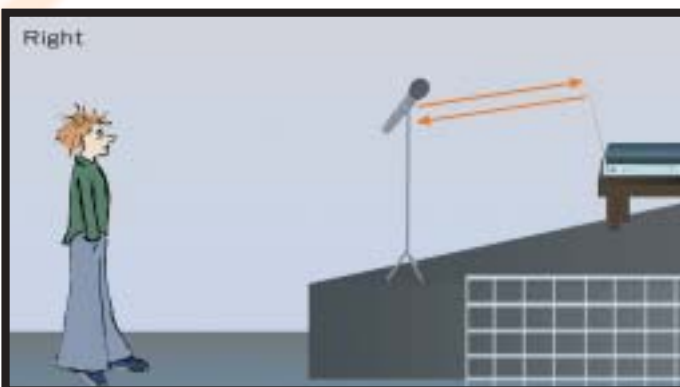

Positioning the receiver

One of the most common mistakes in practice is failing to take the audience into account when positioning the receiver. The basic rule of thumb is: always maintain a line of sight between the transmitter and the receiver. In order to prevent the signal from being absorbed by the audience, always place the receiver as high as possible and in the vicinity of the transmitter – ideally on the stage itself.

HOW WIRELESS TECHNOLOGY WORKS

HOW RADIO SIGNALS ARE TRANSMITTED

Wireless transmission technology is based on the physical principles governing the propagation of electromagnetic waves. Radio, television, mobile telephone communications, microwaves, and light are all based on electromagnetic waves with different wavelengths.

Short waves have completely different characteristics, and are propagated as high-frequency signals in the form of radio waves or X-rays, for instance, traveling incredible distances through the universe and still detectable after millions of years.

Speech and other sound signals, on the other hand, are not electromagnetic waves, and require a high-frequency carrier signal for wireless transmission: it is this carrier signal that serves to transport the audio signal through the air. The process that does the trick is called modulation: this is similar to the audio signal getting into a taxi in a science-fiction movie (climbing into a radio-frequency signal), because the physical laws that now come into effect are similar to the highway code of the future! This metaphorical example is not entirely analogous to the physical reality, but it may give a clearer picture.

What happens to our audio signal once it has entered our metaphorical taxi in order to travel from the transmitter to the receiver? First it has to tell the driver its destination, for example: "Please take me the fastest way

from transmitter to receiver." Since he has been asked to take the fastest route, the taxi driver will try to select this route. However, the thing is that we are not alone on our journey, but have to share the roads with a number of other (wireless) road users: in this situation the following rules apply:

Rule no. 1:
The stronger your radio signal is, the better chance it has of reaching its destination. In our metaphorical example, TV stations do not travel in radio-wave taxis in one lane, but in gigantic trucks occupying several lanes at once. The only solution here is to avoid them by selecting another frequency band, in our example by taking another road so as not to be run over by them!

Rule no. 2:
Keep your distance and stay in your lane! Our taxi needs a road lane on which it can travel, and must keep its distance from vehicles in the adjacent lanes so as to avoid a collision, which we refer to in technical terms as radio interference. Unfortunately, however, we are also obliged to share our lane with signal waves from mobile telephones, television sets, microwave ovens and radio sets, and are permanently faced with congestion and traffic jams. These other signal waves continually come dangerously close to our taxi, and we are continually in danger of colliding with other road users: it is therefore essential that we keep our distance!

Rule no. 3:
The higher the frequency, the more "lanes" there are available, and the risk of various radio signals colliding with one another is correspondingly lower. This is why all WMS 40 systems work in the short-wave UHF range, which ensures extremely reliable transmission and optimal signal quality.

AKG has specified various radio frequencies for its WMS 40 wireless systems in order to ensure secure and reliable transmission in the UHF range, normally enabling four systems to be operated simultaneously. This means that we are able, as it were, to send our audio signals from transmitter to receiver using very fast taxis on four safe road lanes.

This is particularly important when transmitting speech and music in order to avoid unwanted signal dropouts (see illustrations on facing page and also the illustration of signal characteristics on page 7). The maximum number of channels that can be operated simultaneously varies depending on national licensing regulations.

The licensing regulations issued by the relevant regulatory authorities for telecommunications systems also vary from country to country. Your local AKG supplier will be able to tell you whether you require a license to operate a WMS 40 wireless system in your country.

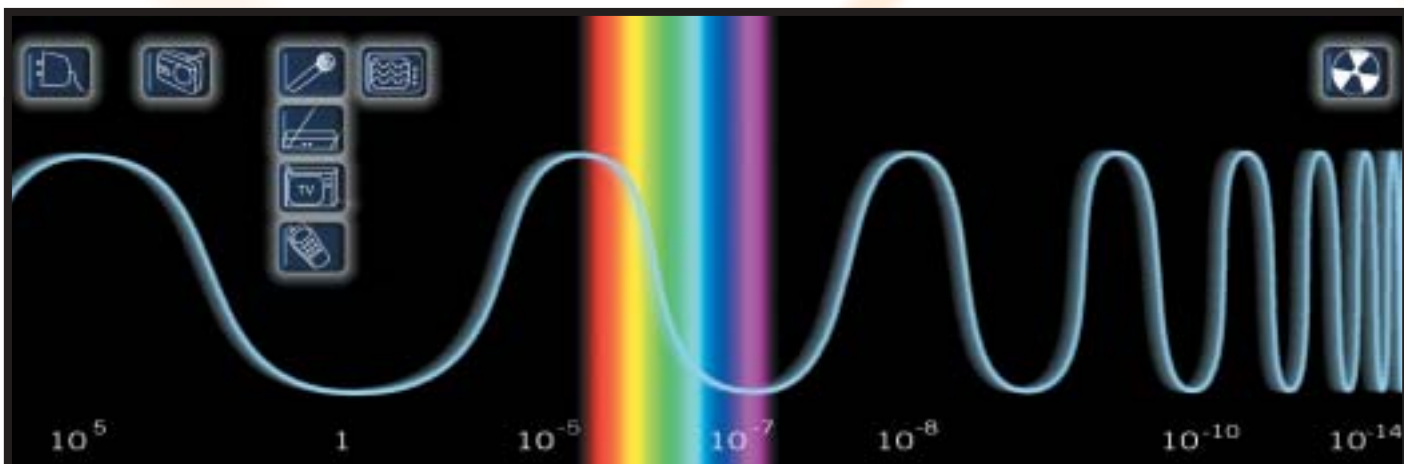

Wavelength

The properties of a wave depend primarily on its wavelength. Wavelength is the term used to refer to the distance between points at which the wave has the same phase in two consecutive cycles. The radio waves of wireless microphone systems, and also television and radio sets, mobile telephones and microwave ovens, have a wavelength of about a meter. The wavelength of visible light varies between 770 and 400 nm (1 nm = 1 thousandth of a meter), whilst X-rays, gamma rays, and cosmic radiation have even shorter wavelengths.

Time scale

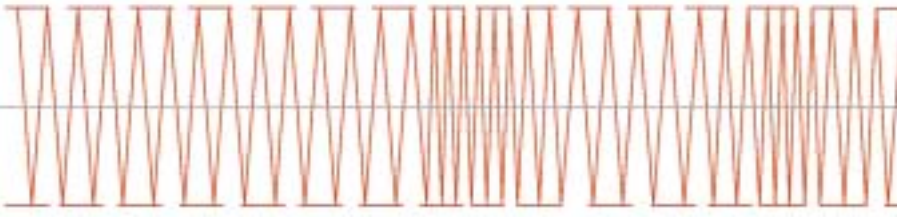

Frequency Modulation (FM)

Transforming an audio signal into a radio-frequency one and back again is achieved by means of frequency modulation (FM). This technology has also been used for decades in UHF radio to ensure reliable transmission and high signal quality. This involves imposing an audio signal on a radio-frequency (RF) sine-wave carrier that now begins to oscillate in time with the audio signal. Variations in the level of the audio signal (changes in volume) produce frequency changes in the RF carrier signal (transmission frequency). Therefore, this technique is known as "frequency modulation".

Bandwidth

Every frequency-modulated carrier signal does not oscillate entirely within the frequency allocated to it, but also occupies frequencies in the adjoining range. This range is known as "bandwidth". The wider the available bandwidth is, the better the transmission quality. Ideally, different carrier signals should therefore be far enough apart to prevent their bandwidths from overlapping.

Frequency scale

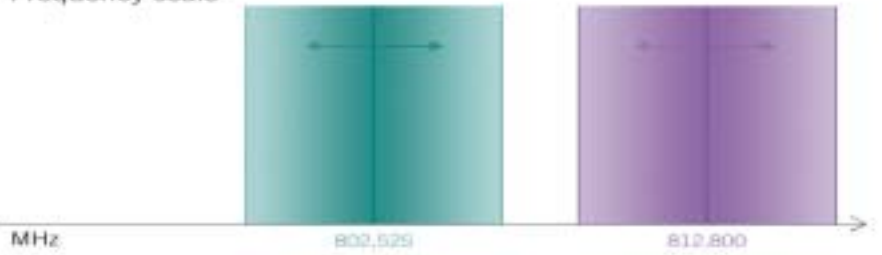

Frequency scale



Interference

Overlapping (interference) occurs when the bandwidths of adjacent signals are too wide, or the carrier frequencies are too close together. Parts of the signals transmitted lying in this range are no longer clearly recognized by the receiver, resulting in noise or dropouts. For this reason it is not possible for two or more systems to work on the same frequency. Even if the frequencies are different, one must always ensure that there is sufficient separation between the frequencies used.

Example of AKG WMS 40 carrier frequencies

AKG has selected fourteen different frequencies as carrier frequencies for wireless transmission by WMS 40 wireless systems. There is sufficient separation between them to ensure trouble-free operation and optimal signal quality. A maximum of four WMS 40 systems can be operated at any one time, and care must be taken to ensure that none of the frequencies are used twice! If more than four radio links are required simultaneously, AKG offers a series of wireless systems that make it possible to use a higher number of channels at once. Please refer to pp. 30 for detailed information. The maximum permissible number of channels may vary depending on national frequency plans.

Frequency scale

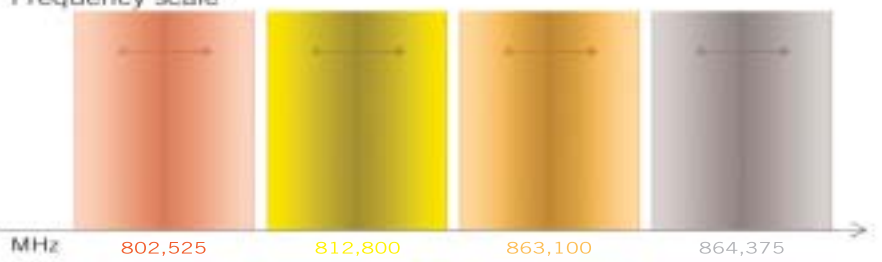

Color coded for easy identification

It is easy to match up transmitters and receivers thanks to their color coding system. At the same time, the colors also tell you the carrier frequency used for the radio link. Transmitters and receivers using the same carrier frequency are coded with the same color. The color code clips on the HT 40, SO 40, MP 40, and GB 40 transmitters are removable, and can be replaced by the black clip provided.



THE WMS 40 MODULAR SYSTEM

MODULAR SOLUTIONS TO MEET INDIVIDUAL REQUIREMENTS

The requirements of wireless systems vary from one user to another. This calls for individual solutions, which is why AKG has created the WMS 40 series as a modular system that offers a wide range of solutions depending on the user's preferences and chosen field of application. Up to four WMS 40 systems can be operated simultaneously: if you need to use more than four radio links at once, you should consider choosing a WMS 400 or WMS 4000 system instead. See pp. 30 for further details. AKG's WMS 40 systems are designed for the future. You can

also use any WMS 40 system with other AKG WMS wireless systems if required. However, if you do, we recommend you visit our website at to check for suitable frequencies before you make your purchase or use the system. For this purpose, AKG offers a service enabling you to input the carrier frequencies of your existing WMS systems. The available carrier frequencies of other AKG WMS systems will then be calculated for you automatically. The maximum permissible number of channels may vary depending on national frequency plans.

The SO 40 snap-on transmitter is the best value WMS system for a singer who already possesses a microphone. However, AKG offers a wide range of professional solutions for a whole spectrum of other applications such as vocals, aerobics, presentations, and the wireless transmission of instruments. In the final analysis, the decisive factors boil down to your individual requirements and the budget you have at your disposal!

The choice is yours...

Lead and backing vocals

Handheld microphone for lead and backing vocals

- Simple plug & play system
- Time-tested AKG D 880^m microphone element
- Over 35 hours of battery-powered operation

Page 12



HT 40



SR 40

Head-worn microphone for lead and backing vocals

- Absolute mobility
- Choice of C 444 L or C 420 L head-worn microphones
- Over 35 hours of battery-powered operation

Page 14



PT 40



C 420 L



SR 40 diversity

Snap-on for easy transition from cable to wireless

- Suitable for any dynamic microphone
- Condenser microphone with internal battery supply
- XLR connector for easy connection
- Optional quick charging station
- Integrated charging contacts

Page 16



SO 40



e.g.
AKG D 880^m



SR 40

TM 40

High Quality Wireless Transmitter Module

- The TM 40 connects to Emotion Tripower Series microphones D 3700^m, D 880^m and C 900^m
- Lowest operating cost in its class
- Input gain control for optimum matching to microphone output level
- ON/MUTE/OFF switch and battery status indicator for easy setup

Page 18



TM 40



e.g.
AKG D 880^m



SR 40 diversity

Presenters

The MP 40 micropen for presenters

- Maximum flexibility of use as handheld, clip-on, or pocket mic
- Superior-quality C 407 capsule
- Optional quick charging station

Page 20



MP 40



PR 40

Handheld microphone for presenters

- Simple plug & play system
- Time-tested AKG D 880[®] microphone element
- Over 35 hours of battery-powered operation

Page 22



HT 40



SR 40

Clip-on or head-worn microphone for presenters

- Absolute freedom of movement
- Choice of C 444 L head-worn or unobtrusive C 417 clip-on microphone
- Over 35 hours of battery-powered operation

Page 22



PT 40



C 444 L



C 417 L



SR 40

Aerobics

Head-worn microphone for extreme activities like aerobics and sports

- Absolute freedom of movement
- C 444 L head-worn microphone specially protected against moisture and perspiration
- Over 35 hours of battery-powered operation

Page 24



PT 40



C 444 L



PR 40

Instruments

Wireless systems for portable instruments

- Absolute mobility
- Choice of a variety of miniature microphones specifically designed for instrument use
- Over 35 hours of battery-powered operation

Page 26



PT 40



MicroMic



SR 40 diversity

Guitar, bass and keyboards

The GB 40 guitarbug for guitar, bass and keyboards

- Flexjack swiveling jack plug connects to all types of electric guitars and basses
- Simple plug & play system
- Optional quick charging station

Page 28



GB 40



PR 40

AKG WMS 40 UHF FOR VOCALS

HANDHELD MICS FOR LEAD AND BACKING VOCALS

The HT 40 handheld transmitter is an excellent choice for both handheld and stand-mounted use. Handheld microphones are also suited for applications where more than one person will talk into the microphone, such as talk shows or interviews with people in the audience.

The design specification for the WMS 40 Series lists the best possible audio quality as the number one priority. The result explains the success of the WMS 40 system. This UHF

wireless microphone system has been optimized for use in smaller venues such as clubs, rehearsal rooms, or local community centers, is easy to use, and provides outstanding price/performance.

The heart of the HT 40 handheld transmitter is the AKG D 880^M microphone element that delivers both an excellent sound and very good intelligibility. This microphone element uses the same transducer as the hot-selling, proven AKG D 880^M hardwire microphone. Made at

the AKG factory in Vienna, Austria, each transducer must pass extremely stringent quality tests before being approved for shipping. This is another reason why both professional and amateur vocalists appreciate this transducer. It guarantees excellent results from the start and is almost indestructible.

With its compact, rack-mountable receiver, the AKG WMS 40 is an easy-to-use, convenient wireless system, and once you tried it you won't want to do without it anymore.



HT 40 Handheld transmitter

Excellent response

The HT 40 handheld transmitter uses the proven AKG D 880^M microphone element. This dynamic transducer has been specifically designed for lead and backing vocals and helps even less experienced vocalists to make themselves heard. An integrated wind and pop screen effectively reduces breath and pop noise as well as sibilance. It is easy to remove the windscreen from the front grill for cleaning.

Massive front grill

An extremely rugged spring steel wire-mesh cap optimally protects the transducer capsule beneath it from damage in tough night-after-night usage on stage. The proven AKG D 880 microphone element easily survives a drop from approx. 3 1/2 feet (1 m) to a hard stone floor. It has been designed to take the kind of abuse usually encountered on tour.

Battery status LED

With a minimum battery life of 35 hours, the HT 40 gives you more hours of fun per dollar than most of its competitors. And if the battery status LED illuminates after all, don't panic: you still got 50 minutes before the batteries are dead so you can easily steal away for a minute to replace them.

ON/MUTE/OFF switch

The absolutely noiseless ON/MUTE/OFF switch with its knurled lever is recessed in the body to prevent unintentional actuation and ensure maximum operational safety.

Integrated antenna

The antenna is hidden inside the rugged transmitter body for optimum protection from damage.

Replaceable color code clip

The color code clip indicates the carrier frequency of the transmitter, and you can replace the colored clip with an inconspicuous black replacement clip if and when the need arises.



Rack mounting

Both the SR 40 and the SR 40 diversity can be used free-standing or rack mounted. An optional rack mounting kit allows you to install the receiver quickly and easily in any 19" rack. The half-rack, 1 U case lets you mount the receivers for six channels in just 3 U of rack space.



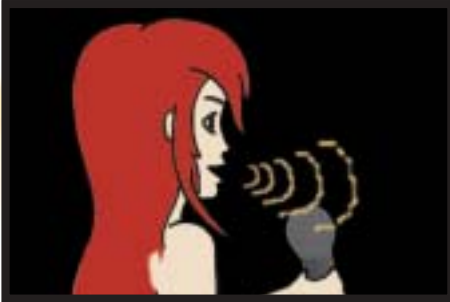

Angle of incidence

To get a well-balanced, natural sound, sing to one side of the microphone or above and across the microphone's top (left). If you sing directly into the microphone, it will not only pick up excessive breath noise but also overemphasize sibilants (right).



Holding the transmitter

Be sure never to cover the lower half of the wire-mesh cap with your hand. If you do, the microphone element's polar pattern will change from cardioid to omnidirectional. In a concert hall, this change in the pickup pattern will significantly lower the usable gain before feedback. Also, do not grasp the transmitter body at the lower end, where your hand would cover the integrated antenna and weaken the radio signal.



Working distance and proximity effect

Basically, your voice will sound the bigger and mellower, the closer you hold the microphone to your lips. Moving away from the microphone will produce a more reverberant, more distant sound as the microphone will pick more of the room's reverberation. Proximity effect is a more or less dramatic boost of low frequencies that occurs when you sing into the microphone from less than 2 inches. It gives more "body" to your voice and a sexy, bass-heavy sound.

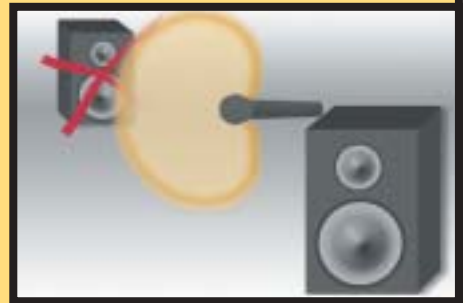

Feedback

To increase usable gain before feedback, the microphone on the HT 40 has a supercardioid polar pattern. This means the microphone is most sensitive to sounds arriving from in front of it (your voice) while hardly responding to sounds arriving from the sides or rear (from monitor speakers for instance). To maximize gain before feedback, never point any microphone directly at a speaker. The safest place for a microphone is usually behind the FOH speakers.

Antenna

The swiveling antenna is mounted on the front panel, allowing the receiver to be rack mounted.

Case

The side panel supports are removable for mounting the receiver in a 19" rack.

Alternative receivers

You can also use the HT 40 with the SR 40 diversity receiver or the PR 40 portable receiver.



Squelch threshold control (on rear panel).

SR 40 Receiver



On/off switch with status LED.

RF LED

Illuminates to indicate that RF signal is being received. If the RF signal fails or the squelch comes on, the MUTE LED will be lit.

Frequency color code platelet

Receivers using the same frequency are marked with the same color code.

Volume

Matches the output level of the receiver to the input gain of the mixer. (For details refer to page 27)



Microphone cleaning and maintenance

Microphones, like any other instrument, need regular cleaning to maintain clarity and intelligibility. As a microphone is being used, its foam pop screen and front grill collect dirt particles that may ultimately clog the acoustically transparent foam cells. Just unscrew the front grill and remove the internal windscreen. Soak the windscreen in sudsy water for a night, then allow it to dry completely. Clean the front grill with isopropyl alcohol.



AKG WMS 40 UHF FOR VOCALS

HEAD-WORN MICS FOR LEAD AND BACKING VOCALS

Head-worn microphones are becoming increasingly popular with vocalists who also play an instrument, or performers needing absolute mobility, particularly those who do not only sing but also dance on stage. The C 420 L and C 444 L from AKG are head-worn condenser microphones that provide a perfect vocal sound, wide dynamic range, and good intelligibility.

Sharing the outstanding, proverbial quality AKG transducers are famous for, these two

microphones deliver excellent sound. Backed by more than fifty years of experience, AKG R&D designed microphone transducers that are small, inconspicuous, extremely light, and do not obstruct the user's field of vision. The transducers are made by AKG in Austria, Europe.

The C 420 L and C 444 L are cardioid microphones that focus their sensitivity at the user's mouth and reduce unwanted off-axis noise to a minimum. The AKG WMS 40

is a UHF wireless system with an outstanding price/performance ratio. It has been designed to bring uncompromising audio to smaller venues such as clubs, rehearsal rooms, or local community centers. It makes professional UHF technology accessible to musicians on a budget and is an ideal choice for lead vocalists as well as singing keyboardists, drummers, guitarists, or dancers. The WMS 40 combines ease of use with a simply fabulous sound!

Flexible antenna

To maintain perfect transmission, the antenna should be visible from the receiver location at all times. So make sure never to cover the antenna with clothes or other elements of the costume.

Mini XLR connector

A locking 3-pin mini XLR connector provides a reliable connection to a head-worn microphone from AKG.

Battery status LED

With a minimum battery life of 35 hours, the PT 40 gives you more hours of fun per dollar than most of its competitors. And if the battery status LED illuminates after all, don't panic: you still got 50 minutes before the batteries are dead so you can easily steal away for a minute to replace them.

ON/MUTE/OFF switch

Setting the switch to the "MUTE" position mutes the audio signal, while the transmitter continues radiating the RF carrier frequency. This prevents the receiver from being disturbed by other transmitters while the microphone is "off the air".



PT 40 Portable transmitter



Rear panel and battery compartment

Belt clip for fixing the transmitter to a belt.
 Frequency and color code label for easy frequency identification in a multichannel system.
 MIC/LINE selector: Sets the audio section input either to MIC or LINE level.
 GAIN: Fine adjusts the sensitivity of the transmitter's audio section to the output level of the connected microphone or instrument.





Rack mounting

Both the SR 40 and the SR 40 diversity can be used free-standing or rack mounted. An optional rack mounting kit allows you to install the receiver quickly and easily in any 19" rack. The half-rack, 1 U case lets you mount the receivers for six channels in just 3 U of rack space.



Antennas

The swiveling antennas are mounted on the front panel, allowing the receiver to be rack mounted.



SR 40 diversity Receiver

AF LEDs

The green AF LED indicates the input level to the audio section is within the optimum range. If the audio input level is too high, the PEAK LED will come on.

ON/OFF switch
with status LED.

Case

The 1 U half-rack case is easy to mount in a rack and allows you to install two receivers in a single slot.

Diversity LEDs

Indicate which of the two receiving antennas is currently active.

RF LED

Illuminates to indicate that RF signal is being received. If the RF signal fails or the squelch comes on, the MUTE LED will be lit.

Frequency color code platelet

Receivers using the same frequency are marked with the same color code.

Volume

Matches the output level of the receiver to the input gain of the mixer. (For details refer to page 27).

Alternative receivers

You can also use the PT 40 with the SR 40 stationary receiver or the PR 40 portable receiver.



C 420L

A fully adjustable behind-the-neck steel headband with swiveling temple pieces provides a secure yet gentle fit.

The cable is connected at the back of the head so it won't get into the user's way during the performance.

The microphone arm places the mic in front of the user's mouth, a position suited for professional vocalists who know how to sing and breathe to avoid causing breath and pop noise.

AKG WMS 40 UHF FOR VOCALS

SO 40 SNAPON TRANSMITTER CONVERTS HARDWIRE MICS TO WIRELESS

Does this sound familiar? You've been using your favorite hardwire dynamic microphone for gigs and rehearsals for years and one night it turns out that for this particular gig it would be very convenient to have the same microphone with a radio link instead of the cable. The radio link would have to be small, light, and affordable, because you travel a lot and would rather not spend a lot of money on a full-blown wireless system that you will only use occasionally.

It was exactly for this application that AKG designed the Microtools Series SO 40 snapon transmitter that was enthusiastically wel-

comed by the audio community when it was launched and has been appreciated by many users ever since.

Knowing that the most successful products are usually surprisingly simple, the designers at AKG did their homework with painstaking care and finally came up with the SO 40 snapon transmitter, a miniature transmitter designed specifically for direct connection to a microphone. The SO 40 snapon transmitter has a 3-pin XLR connector that allows you to connect the transmitter directly to any dynamic microphone (e.g., an AKG D 880) or a condenser microphone with an internal

power supply (e.g., the AKG C 1000 S). The transmitter can be powered from a dry or rechargeable battery. A suitable charger is available from AKG.

Converting a hardwire microphone to wireless has never been so easy and affordable before. Even if you use several hardwire microphones from various manufacturers for various applications, you can now convert all these microphones to wireless easily and without having to buy several different wireless systems. In short, the SO 40 snapon transmitter gives you incredible wireless flexibility at very moderate cost.

SO 40 snapon transmitter

Release button

Unlocks the XLR connector.

XLR connector

3-pin female XLR connector for direct connection to a dynamic microphone with a 3-pin male XLR connector.

Color code

Transmitters and receivers tuned to the same carrier frequency are marked with the same color.

Battery compartment

The transmitter can be powered from a dry or rechargeable battery. The color of the battery compartment cover indicates the carrier frequency of the transmitter, and you can replace the colored cover with a black replacement cover.

Input gain control

Matches the transmitter audio input sensitivity to the microphone's output level.

Antenna

Rugged antenna integrated in the transmitter body.

Battery status LED

Battery life is approx. eight hours for an AAA size 1.5 V dry battery and approx. six hours for a rechargeable battery. When the status LED is lit red constantly the battery will be dead in about 50 minutes. The maximum charging time for a rechargeable battery is one hour.

ON/MUTE/OFF switch

Setting the switch to the "MUTE" position mutes the audio signal, while the transmitter continues radiating the RF carrier frequency. This prevents the receiver from being disturbed by other transmitters while the microphone is "off the air".

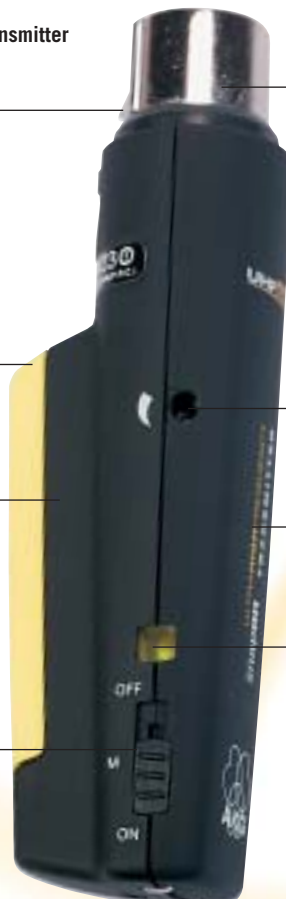

Kind to your budget and the environment

The optional CU 40 charger provides a convenient way of charging the battery inside the transmitter via the charging contacts on the transmitter bottom panel. You don't even have to remove the battery for charging! Unlike conventional chargers, the CU 40 checks whether the battery inside the transmitter is a dry or rechargeable type and switches off automatically if it detects a dry battery. A quick charging function makes sure the batteries inside any AKG Microtool will be fully charged within one hour.





XLR connector

Plug it in. That's all you need to do to convert any hardwire dynamic mic to wireless. Obviously, you can use the SO 40 to add a radio link to any other audio source with an XLR output as well. The XLR connector on the SO 40 is wired for pin 2 hot (international standard).



SO 40 Input wiring diagram

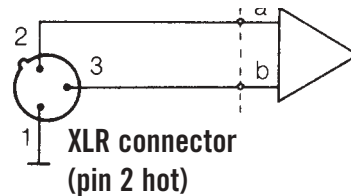

Antenna

The swiveling antenna is mounted on the front panel, allowing the receiver to be rack mounted.

Case

The side panel supports are removable for mounting the receiver in a 19" rack.

Alternative receivers

You can also use the SO 40 with the SR 40 diversity receiver or the PR 40 portable receiver.



SR 40 Receiver

ON/OFF switch
with status LED.

RF LED
Illuminates to indicate that RF signal is being received. If the RF signal fails or the squelch comes on, the MUTE LED will be lit.

Frequency color code platelet
Receivers using the same frequency are marked with the same color code.

Volume
Matches the output level of the receiver to the input gain of the mixer. (For details refer to page 27).



Setting the squelch threshold

The job of a squelch circuit is to reduce audible noise. It eliminates noise during pauses in the audio signal by muting the receiver every time the audio level drops below a defined threshold. The SQUELCH control on the receiver sets this threshold. Use the SQUELCH control with care! If the squelch threshold is too high, the squelch will not only cut out noise but mute quiet audio signals as well because the squelch responds to the detected voltage and cannot distinguish between wanted signal and noise. Besides that, a too high squelch threshold also decreases the usable range.

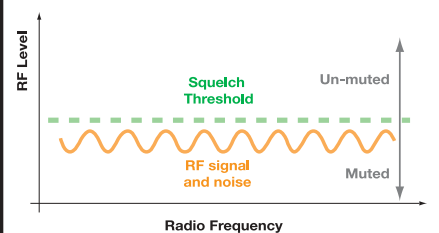

AKG WMS 40 UHF FOR VOCALS

THE TM 40 - MODULAR SYSTEM FOR SOPHISTICATED STAGE APPLICATIONS

Sooner or later in the life of every singer, the time comes when you need to buy a rugged stage microphone with that fabulous sound. But that's when you find yourself in a dilemma: do you need a hardwire or a wireless mic? A hardwire model is perfectly adequate for the rehearsal room, where it is often impossible to use a radio system due to the small distances involved. On the other hand, the benefits of a wireless microphone during a live performance are obvious: no endlessly long cables, and complete freedom of movement. But this is hardly enough to make you want to buy two microphones.

This problem is now a thing of the past thanks to the revolutionary TM 40 transmitter module. Depending on the situation, with an easy adjustment you can use this microphone with or without a cable.

It goes without saying that you can always opt for the hardwire version to begin with if your budget is limited. You can subsequently upgrade to the wireless version at any time without being annoyed about owning a hardwire mic you no longer need.

The TM 40 transmitter module is based on

the same technology as AKG's extremely successful WMS 40 range, which offers a genuine plug & play system for up to six channels. This ensures problem-free operation of all optional accessories – from receiver to charger – with your TM 40. A built-in on/mute/off switch, clearly visible status LED, and input gain control ensure unrivaled ease of use.

What microphone you will ultimately choose depends only on your personal preference as a performer: dynamic or condenser, cardioid or supercardioid – every possible combination is available.

TM 40 Transmitter module



Status LED

Allows you to check the status of the battery inside your transmitter. The TM 40 will operate for about 8 hours off a 1.5 V AAA size dry battery, and about 6 hours off a rechargeable battery. When the status LED lights up red continuously, the battery will last about another 50 minutes: recharging takes an hour at most.

On/mute/off switch

With the mute function selected, only the audio signal is muted: the supply voltage and RF carrier frequency remain switched on. This prevents other transmitters from interfering with the receiver although the microphone is "switched off".

Input gain control

Allows you to adjust the sensitivity of the audio input on the TM 40.

Battery compartment

You can operate the microphone with either dry or rechargeable batteries. Integrated charging contacts in the bottom of the microphone allow you to charge the battery without removing it.



Battery charging made easy

Use the optional CU 40 charger to recharge the battery in the battery compartment via the integrated contacts in the bottom of the transmitter body. The battery is recharged within one hour and can then be used for up to 6 hours. Battery charging simply couldn't be easier, faster, or more ecological!





D 3700^M

D 3800^M

C 5900^M

D 880^M

C 900^M

Wireless and supremely flexible

The TM 40 has been designed for use with any Emotion/Tripower Series microphone. You can choose between the D 3700^M cardioid dynamic or the D 3800^M supercardioid dynamic, the C 5900^M supercardioid condenser microphone, and the D 880^M cardioid dynamic, or the C 900^M cardioid condenser microphones. AKG offers the right microphone for every budget and every performance requirement – and the plug-in transmitter module makes it incredibly easy to switch between hardwire and wireless modes!

RF LEDs

Illuminate to indicate a signal is being received. The mute LED lights up if the signal is lost or the squelch is active.

AF LEDs

Green indicates optimal input signal strength. The Peak LED will come on when the input level is too high.

Antennas

The folding antennas are mounted on the front panel of the SR 40 diversity, making for easier rack installation.



SR 40 diversity Receiver

On/Off switch

Case

1 U half-rack case for convenient, space-saving rack installation.

Alternative receivers

As alternatives you can also choose between the SR 40 receiver and the PR 40 portable receiver.



Diversity LEDs

Indicate which of the two diversity antennas is active at any time.

Volume

Lets you match the output level to the input sensitivity of the mixing desk and the related gain structure (see explanation on page 27).

Frequency color coding

Receivers using the same frequency are marked with the same color code.

Several types of XLR modules

These modules with XLR connectors allow you to use your microphone with a cable. Gold plated contacts ensure maximum reliability. The XLR modules for the D 880^M, D 3700^M and D 3800^M dynamic microphones are available with or without an on/off switch. The XLR module for the C 900^M condenser comes with no switch, while the XLR module for the C 5900^M provides dip switches for bass rolloff and presence boost. This enables you to switch from wireless to hardwire modes in a matter of seconds.



AKG WMS 40 UHF FOR PRESENTERS

THE MP 40 MICROPEN FOR PRESENTERS

Designed for presentations, lectures, video shooting, and tour guide systems, the MP 40 micropen has been extremely popular for its versatility. Elegant and inconspicuous, it is small enough to fit in a jacket pocket.

Besides ease of handling, the MP 40 micropen also provides excellent intelligibility. The MicroPen can even be used as a handheld microphone, e.g., for interviews or talk shows so the reporter or host can give the microphone to the interviewee or a second moderator if necessary. To improve intelligibility and gain before feedback, it may sometimes

be necessary to increase the proportion of direct sound by placing the microphone closer to the user's mouth. To this end, either use the convenient necklace cord supplied with the MP 40 micropen, or remove the microphone from the transmitter and clamp it on the lapel.

The C 407 omnidirectional condenser microphone is a proven design that has been specifically optimized for miking up the speech frequency range. It is so small that it will almost disappear against its backing. Integrated in the transmitter is a special

compartment that keeps the microphone from falling out and protects it from damage.

The transmitter can be powered from a single AAA size dry or rechargeable battery. Battery life is approx. eight hours for a dry battery and approx. six hours for a rechargeable battery. Charging is as easy as placing the transmitter in the optional CU 40 charger. The battery will be restored to full capacity in half an hour.

Just about time enough for a cup of coffee before the next lecture begins.

MP 40 Micropen



ON/MUTE/OFF switch

Setting the switch to the "MUTE" position mutes the audio signal, while the transmitter continues radiating the RF carrier frequency. This prevents the receiver from being disturbed by other transmitters while the microphone is "off the air".

Battery status LED

Battery life is approx. eight hours for an AAA size 1.5 V dry battery and approx. six hours for a rechargeable battery. When the status LED is lit red constantly the battery will be dead in about 50 minutes. The maximum charging time for a rechargeable battery is one hour.

Cable compartment

The microphone cable is stored in a separate compartment with a removable cover.

Battery compartment

The transmitter can be powered from a dry or rechargeable battery.

Microphone

The AKG C 407 omnidirectional microphone has been optimized for speech pickup. A crocodile clip lets you use the microphone remotely from the transmitter. The cable is approx. 8 inches (20 cm) long.

Color code pen clip

Transmitters and receivers tuned to the same carrier frequency are marked with the same color.

Input gain control

Sets the sensitivity of the transmitter's audio section.

Antenna

Rugged antenna integrated in the transmitter body.



Kind to your budget and the environment

The optional CU 40 charger provides a convenient way of charging the battery inside the transmitter via the charging contacts on the transmitter bottom panel. You don't even have to remove the battery for charging! Unlike conventional chargers, the CU 40 checks whether the battery inside the transmitter is a dry or rechargeable type and switches off automatically if it detects a dry battery. A quick charging function makes sure the batteries inside any AKG Microtool will be fully charged in less than one hour.





Detachable microphone

Where gain before feedback is no problem, leave the microphone safely nested in its compartment. In more acoustically difficult environments, remove the microphone from the transmitter and attach it to the clothes nearer the user's mouth using the crocodile clip on the microphone.



Put it in your pocket ...

... like a ballpoint pen. You can replace the colored clip with an inconspicuous black clip if necessary.

MP 40 micropen with detached microphone

To improve intelligibility, you can use the integrated cable and crocodile clip on the microphone to attach the microphone to the clothes, near the user's mouth. Reception conditions permitting, you can even hide the transmitter in an inside pocket.

MP 40 micropen in handheld mode

For interviews, etc., you can use the MicroPen in the same way as a conventional handheld microphone. Remember, though, that the sensitivity of the MP 40 is higher than that of most conventional models.

For more products/hints for presenters, refer to the next page.

Volume

Sets the volume level of the headphone output. (See page 27 for details.)

Antennas

The swiveling antennas can be set to any angle.

ON/OFF switch with status LED.

PR 40 Portable receiver

RF LED

Illuminates to indicate that RF signal is being received. If the RF signal fails or the squelch comes on, the RF LED will go out.

Case

Featuring an exceptionally light and compact case, the PR 40 can be easily attached to a belt, camera, pedalboard, etc. using the belt clip or supplied Velcro strip.

Bottom panel charging contacts

The charging contacts allow you to charge the batteries inside the PR 40 using the optional CU 40 charger.

Alternative receivers
You can also use the MP 40 with the SR 40 or SR 40 diversity receiver.



AKG WMS 40 UHF FOR PRESENTER

MORE GOODIES FOR PRESENTERS

You can use a C 444 L head-worn or C 417 L lavalier microphone with a PT 40 bodypack transmitter with 35 hours battery life. The C 444 L has been optimized for speech pickup and rests securely yet gently against the user's cheekbone. This setup provides unrestricted mobility and the microphone keeps clear of the user's field of vision.

The C 417 L lavalier microphone is small and inconspicuous. Fixed to the selvedge or a buttonhole on the presenter's jacket, it is nearly invisible and therefore a popular choice for applications where the microphone or transmitter must keep a low profile.

The HT 40 transmitter is the optimum solution for any application where a handheld microphone is needed. This microphone is the first choice for applications where more than one person will talk into the microphone, such as talk shows with several hosts or interviews with people in the audience. The HT 40 handheld transmitter uses the same transducer as the hot-selling, proven AKG D 880^M handheld microphone. Made at the AKG factory in Vienna, Austria, this rugged transducer provides accurate speech response and is almost indestructible. The ON/MUTE/OFF switch is easy to use and recessed to prevent unintentional activation.

The SO 40 snapon transmitter is the ideal solution for users who may need a wireless microphone, but not often enough to warrant the purchase of a dedicated wireless system.

The SO 40 snapon transmitter is a convenient, lightweight miniature transmitter that allows you to convert an existing hardwire microphone to a radio mic at a very affordable price. With its 3-pin XLR connector, the SnapOn connects directly to any dynamic microphone.

For more details on the PT 40 refer to page 14.

For more details on the HT 40 refer to page 12.

For more details on the SO 40 snapon transmitter refer to page 16.



PT 40 Bodypack transmitter
with C 444 L head-worn or C 417 L lavalier microphone.



HT 40 Handheld transmitter
with proven D 880^M microphone element.



SO 40 snapon transmitter
Microtool for easy conversion of hardwire dynamic microphones.



C 444 L

A flexible plastic behind-the-neck arch and large support pads resting gently against the head keep the C 444 L securely in place without pinching.

The flexible microphone arm absorbs mechanical impact and places the microphone near the corner of the user's mouth to prevent pop and breathing noise from being picked up as it would if the mic were positioned right in front of the mouth.



C 417 L

The C 417 L is one of the smallest lavalier microphones available today and provides exceptional price/performance. With its wide frequency range and omnidirectional pickup pattern with no proximity effect, the C 417 L is an ideal choice for announcers and presenters.

Antenna

The swiveling antenna is mounted on the front panel, allowing the receiver to be rack mounted.

Case

The side panel supports are removable for mounting the receiver in a 19" rack.

Alternative receivers

You can also use the PT 40 with the SR 40 diversity receiver or the PR 40 portable receiver.

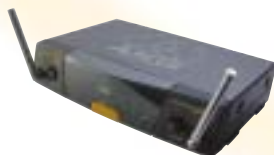

SR 40 Receiver

ON/OFF switch
with status LED.

RF LED

Illuminates to indicate that RF signal is being received. If the RF signal fails or the squelch comes on, the MUTE LED will be lit.

Frequency color code platelet

Receivers using the same frequency are marked with the same color code.

Volume

Matches the output level of the receiver to the input gain of the mixer. (For details refer to page 27).

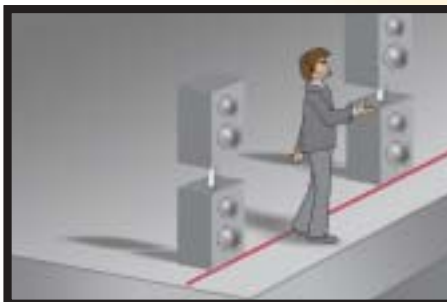

Avoiding feedback

As soon as an open mic gets into the coverage area of one or more loudspeakers (left), it will pick up the speaker signal and recirculate it through the amps and speakers to the point that the system starts whistling or howling at an ear-splitting level. This is called feedback. The FOH speakers are usually set up at the front edge of the stage and it is relatively easy to stay behind an imaginary line between the speakers (right). Presenters moving around on stage should make sure never to point the microphone at any of the speakers.

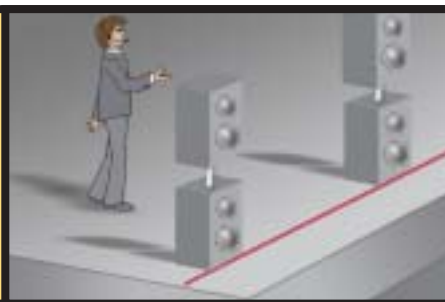

AKG WMS 40 UHF FOR SPORTS

WIRELESS SYSTEMS FOR MAXIMUM MOBILITY

Wireless microphone systems are becoming increasingly popular in sports arenas, fitness or dance studios for efficient communication between athletes and trainers. The WMS 40 Sports System is a complete solution designed for the specific needs of athletes and trainers. The head-worn microphone affords maximum mobility. It is rugged, light, and will stay in place even if the user moves their head abruptly. A flexible plastic behind-the-neck arch and large support pads keep the microphone securely in place without restricting the athlete's field

of vision. The flexible microphone arm with a special moisture shield absorbs mechanical impact and places the microphone near the corner of the user's mouth. Since the user will not talk directly into the microphone, it will pick up almost no pop or breathing noise. The PT 40 bodypack transmitter features a belt clip for easy and secure fastening to the user's belt or clothes. Alternatively, you can use the supplied light, padded neoprene bag that protects the transmitter from perspiration and impact.

Wireless microphones can be used for many applications from training at the gym to championships in any sports, for communication between trainers and athletes or direct connection to the sound system at a stadium.

The WMS 40 Sports System provides tailor-made speech reinforcement solutions for gyms, sports clubs, and teams that are easy to connect to an existing sound system at a gym, hall, or open-air arena, and guarantee users the required mobility.

Flexible antenna

To maintain perfect transmission, the antenna should be visible from the receiver location at all times. So make sure never to cover the antenna with clothes or other elements of the costume.

Mini XLR connector

A locking 3-pin mini XLR connector provides a reliable connection to a head-worn microphone from AKG.

Battery status LED

With a minimum battery life of 35 hours, the PT 40 gives you more hours of fun per dollar than most of its competitors. And if the battery status LED illuminates after all, don't panic: you still got 50 minutes before the batteries are dead so you can easily steal away for a minute to replace them.

ON/MUTE/OFF switch

Setting the switch to the "MUTE" position mutes the audio signal, while the transmitter continues radiating the RF carrier frequency. This prevents the receiver from being disturbed by other transmitters while the microphone is "off the air".



PT 40 Portable transmitter



Training communications

Instructions are often drowned out by ambient noise. The PT 40 Sports System in conjunction with a powered speaker or amp and speaker reduces the strain on the trainer's voice and gets their instructions across clearly. The result is better communication for more efficient training.





C 444 L

A flexible plastic behind-the-neck arch and large support pads resting gently against the head keep the C 444 L securely in place without pinching. The flexible microphone arm absorbs mechanical impact and places the microphone near the corner of the user's mouth to prevent pop and breathing noise from being picked up as it would if the mic were positioned right in front of the mouth.

Important: The C 444 L delivers a very high output level, so be sure to set the MIC/LINE selector on the PT 40 to "LINE" to avoid overloading the PT 40's audio input.

Volume
Sets the volume level of the headphone output. (See page 27 for details.)

Antennas

The swiveling antennas can be set to any angle.

ON/OFF switch
with status LED.

PR 40 Portable receiver

RF LED

Illuminates to indicate that RF signal is being received. If the RF signal fails or the squelch comes on, the RF LED will go out.

Alternative receivers

You can also use the PT 40 with the SR 40 or SR 40 diversity receiver.

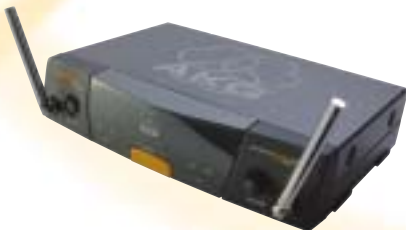

Case

Featuring an exceptionally light and compact case, the PR 40 can be easily attached to a belt, camera, pedalboard, etc. using the belt clip or supplied Velcro strip.

Bottom panel charging contacts

The charging contacts allow you to charge the batteries inside the PR 40 using the optional CU 40 charger.



PT 40 care

Particularly when used by gymnastics trainers, the PT 40 is not only subjected to mechanical stress but above all the corrosive effects of perspiration. Therefore, you should always use the PT 40 with the supplied neoprene bag.

Should this be impossible for some reason, wear the PT 40 with the antenna pointing down if you use it with a head-worn microphone. This will prevent perspiration from creeping along the cable and finding its way into the transmitter.

AKG WMS 40 UHF FOR INSTRUMENTS

RADIO LINKS FOR PORTABLE INSTRUMENTS

More and more musicians prefer wireless microphones, so AKG was asked to create a wireless system specifically for "minimally invasive" miking of acoustic instruments with no on-board pickup. The proven AKG MicroMic Series microphones in conjunction with the AKG PT 40 bodypack transmitter and SR 40 portable receiver provide a solution offering exceptional quality, price/performance, and flexibility. Since the high quality MicroMic Series microphone capsules require high-performance

production lines they are made at the AKG factory in Vienna, Austria. Expensive UHF technology has been optimized for the specific requirements of wireless systems for smaller venues such as clubs, rehearsal rooms, or local community centers.

The WMS 40 provides fully professional audio and UHF transmission quality adjusted to the needs of musicians on a budget. The MicroMic Series includes a wide choice of small, light microphones designed for

easy mounting on various instruments and liberates musicians from the constraints imposed by stand-mounted microphones.

Of course, all MicroMics will leave no trace on the instrument when you remove them. Using an AKG WMS 40 Bodypack System with AKG MicroMic Series microphones is an optimum solution for acoustic guitar, violin, banjo, zither, accordion, various wind instruments, and many other applications.

Flexible antenna

To maintain perfect transmission, the antenna should be visible from the receiver location at all times. So make sure never to cover the antenna with clothes or other elements of the costume.

Mini XLR connector

A locking 3-pin mini XLR connector provides a reliable connection to a head-worn microphone from AKG.

Battery status LED

With a minimum battery life of 35 hours, the PT 40 gives you more hours of fun per dollar than most of its competitors. And if the battery status LED illuminates after all, don't panic: you still got 50 minutes before the batteries are dead so you can easily steal away for a minute to replace them.

ON/MUTE/OFF switch

Setting the switch to the "MUTE" position mutes the audio signal, while the transmitter continues radiating the RF carrier frequency. This prevents the receiver from being disturbed by other transmitters while the microphone is "off the air".



PT 40 Portable transmitter



MIC/LINE selector and GAIN control

Set the MIC/LINE selector (left) to the correct position depending on whether you connected a microphone or instrument to the transmitter. Since instruments deliver a much higher output level than microphones do, set the selector to "LINE" for instruments and to "MIC" for microphones to avoid spectacularly overloading the transmitter's audio input or getting an extremely weak audio signal. The GAIN control (right) lets you fine adjust the audio section gain to the output level of the connected instrument or microphone.





MicroMic C 411 L pickup

For guitar, violin, viola, banjo, zither, or hammered dulcimer. Fix the pickup near the bridge (left).

D 409 instrument MicroMics

For saxophone, clarinet, tubas, trombone, trumpet.



C 416 L instrument MicroMic

To mic up an accordion, use two AKG C 416 L with a B 29 L battery supply/mini mixer.



C 419 L instrument MicroMics

For saxophone, clarinet, tubas, trombone, trumpet.

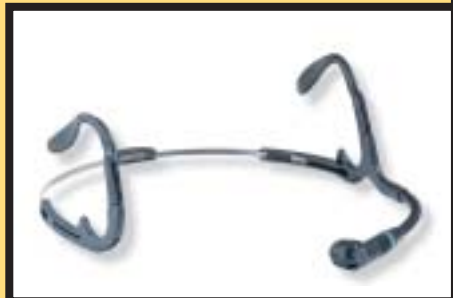

C 420 L head-worn MicroMic

For flute and harmonica.

For detailed hints on using MicroMics refer to pages 80/81.

RF LEDs

Illuminates to indicate that RF signal is being received. If the RF signal fails or the squelch comes on, the MUTE LED will be lit.

AF LEDs

The green AF LED indicates the input level to the audio section is within the optimum range. If the audio input level is too high, the PEAK LED comes on.

Antennas

The swiveling antennas are mounted on the front panel, allowing the receiver to be rack mounted.

SR 40 diversity Receiver

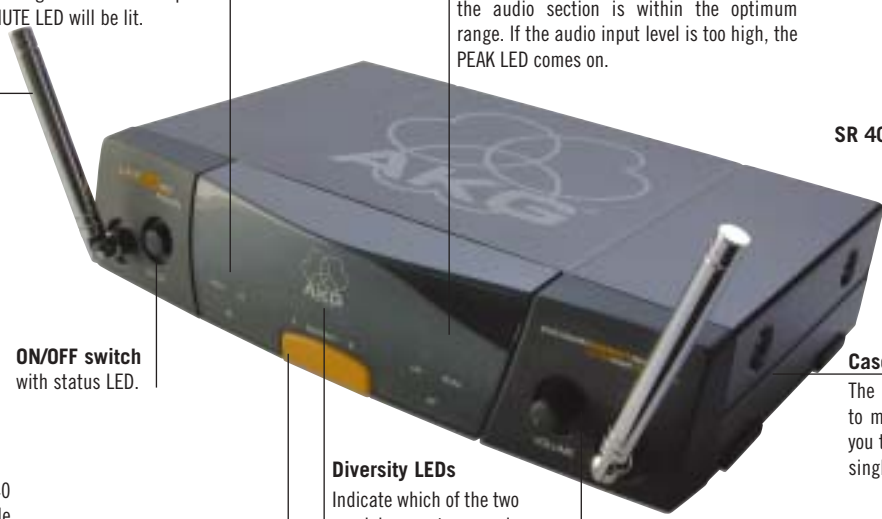

ON/OFF switch with status LED.

Case

The 1 U half-rack case is easy to mount in a rack and allows you to install two receivers in a single slot.

Alternative receivers

You can also use the PT 40 with the SR 40 stationary receiver or the PR 40 portable receiver.

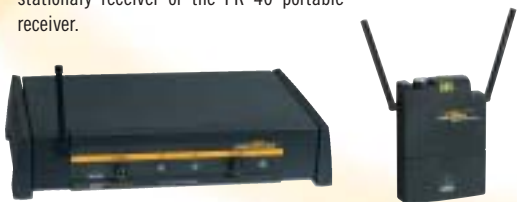

Diversity LEDs

Indicate which of the two receiving antennas is currently active.

Volume

Matches the output level of the receiver to the input gain of the mixer. (For details see illustration below)

Frequency color code platelet

Receivers using the same frequency are marked with the same color code.

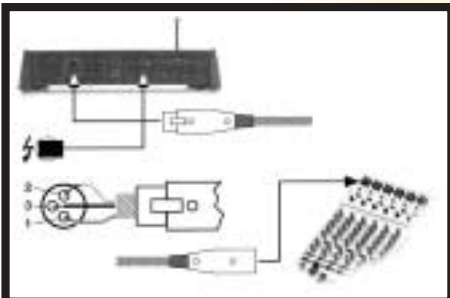

Connecting to microphone or line inputs

Use an XLR cable to connect the MIC OUT socket on the SR 40 to a balanced (XLR) microphone input on the mixer. Turn the VOLUME control on the SR 40 all the way CCW (left). Use an XLR to 1/4" cable to connect the LINE OUT socket on the SR 40 to an unbalanced line input (1/4" jack) on the mixer. Turn the VOLUME control on the receiver all the way CW (right).

Never use both receiver outputs simultaneously! This may cause a loss in signal level and increased noise.

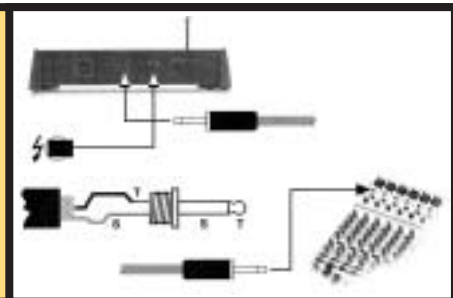

AKG WMS 40 UHF FOR GUITAR & BASS

THE GB 40 GUITARBUG FOR GUITAR AND BASS

Too long. Too short. Forgot it. Tied up in knots. Tangled up. Gone. Pins reversed. Disconnected. Broken. Must be hard to find a guitarist or bassist who never got furious about their cables and the related mess.

The convenient alternative from AKG is called the GB 40 guitarbug, a WMS 40 Microtools Series miniature transmitter specifically designed for guitars and basses. It matches any instrument with a 1/4" TS jack, including keyboards. The spring-

loaded "FlexJack" swiveling jack plug connects to the instrument and pulls the transmitter against the instrument. The soft-touch coating on the transmitter bottom panel stabilizes the transmitter on the instrument and prevents the instrument surface from being scratched.

The GB 40 guitarbug is a UHF transmitter with superior price/performance. Optimized for use by guitarists and bassists at small clubs, rehearsal rooms, or local community centers, it is exceptionally easy to use.

The operating cost of the GB 40 is surprisingly low, too. A single AAA size 1.5 V dry battery will last for about eight hours of continuous playing. If you use many battery powered effects units and tuning devices, spending an appreciable part of your fees on batteries for your equipment, you can power the GB 40 with a rechargeable battery (six hours battery life). The optional CU 40 charger will fully charge the GB 40 guitarbug in half an hour, and the half-rack receiver can be rack mounted as easily as you can put it in your guitar bag.

GB 40 guitarbug

Jack plug

Spring-loaded FlexJack™ 1/4" TS jack plug. The plug may be too short for some recessed instrument jacks. In this case, use the supplied extension plug.

Battery status LED

Battery life is approx. eight hours for an AAA size 1.5 V dry battery and approx. six hours for a rechargeable battery. When the status LED is lit red constantly the battery will be dead in about 50 minutes. The maximum charging time for a rechargeable battery is one hour.

Flexible antenna

To maintain perfect transmission, the antenna should be visible from the receiver location at all times. So make sure never to cover the antenna with clothes or other elements of the costume.

ON/MUTE/OFF switch

Setting the switch to the "MUTE" position mutes the audio signal, while the transmitter continues radiating the RF carrier frequency. This prevents the receiver from being disturbed by other transmitters while the microphone is "off the air".

Input gain control

Sets the sensitivity of the transmitter's audio section.

Battery compartment

The transmitter can be powered from a dry or rechargeable battery. The color of the battery compartment cover indicates the carrier frequency of the transmitter and you can replace the colored cover with a black replacement cover if required.



Accessories

We recommend using the optional CU 40 charger to charge the battery inside the battery compartment. The bottom panel charging contacts eliminate the need to remove the battery for charging.

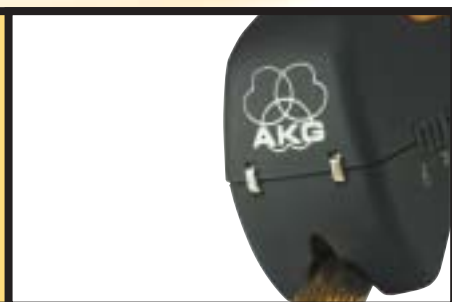



Guitar system in a bag

The GB 40 guitarbug plus SR 40 is a convenient, user-friendly way to replace a guitar cable with a radio link. It is small enough to fit in any guitar case and will be ready to operate at any time.

* Strings are not supplied with the system.



Volume

Sets the volume level of the headphone output. (See page 27 for details.)

ON/OFF switch
with status LED.

PR 40 Portable receiver

Antennas

The swiveling antennas can be set to any angle

RF LED

Illuminates to indicate that RF signal is being received. If the RF signal fails or the squelch comes on, the RF LED will go out.

Case

Featuring an exceptionally light and compact case, the PR 40 can be easily attached to a belt, camera, pedalboard, etc. using the belt clip or supplied Velcro strip.

Alternative receivers

You can also use the GB 40 with the SR 40 or SR 40 diversity receiver.



Bottom panel charging contacts

The charging contacts allow you to charge the batteries inside the PR 40 using the optional CU 40 charger.



FlexJack for all electric guitar models

The FlexJack connects to guitar jacks on the side (left) or top (right).



FlexJack for all electric/acoustic guitar models

The FlexJack connects to guitar jacks in the strap button.



FlexJack for all electric bass models

The FlexJack connects to bass jacks on the side or top.



FlexJack for all portable keyboards

The FlexJack connects to keyboard jacks. Use two WMS 40 systems for a stereo keyboard.

HOW MULTICHANNEL TECHNOLOGY WORKS

FREQUENCY MANAGEMENT, INTERFERENCE, AND PRACTICAL REMEDIES

A knowledge of the laws of physics governing the propagation of radio waves is essential if one is to gain maximum benefit from the advantages of wireless transmission technology. Radio waves are electromagnetic waves that are used as a carrier for the transmission of signals.

In physical terms, electromagnetic waves transport energy through space. In a vacuum, they are propagated at the speed of light (in other media almost the speed of light, 300,000 km/s). The relationship between frequency and wavelength is defined by the following equation:

$$\lambda = c/f$$

(wavelength = speed of light / frequency)

The speed of electromagnetic waves and their ability to pass through obstacles varies depending on their wavelength. Due to the growing popularity of wireless communications such as wireless, radio/television broadcasting, mobile telephony, and wireless LAN networks, the density of the radio signals around us is rapidly increasing (see illustration below). Consequently, there is also a greater risk of disturbances caused by RF interference and electrosmog.

Dropouts are the result of zero RF field strength at a receiving antenna. One reason may simply be excessive separation between transmitter and receiver so the receiver will capture no sig-

nal. Another reason may be multipath reception: as the signal is reflected several times, the resulting multiplied signals arrive at the receiving antenna from different directions and in different phases. When this occurs, they may cancel one another out, resulting in signal dropout. Another type of dropouts may be caused by interference that will become audible as noise if the carrier signal is sufficiently weakened. In order to prevent this, most receivers are equipped with a muting circuit. Provided this circuit is fast enough, and the muting threshold is just above the electrosmog level, it can switch off the audio circuit whilst the signal level drops as described above. It is not possible to completely suppress dropout, which is often accompanied by a crackling sound.

The best way to prevent interference is to eliminate the source of unwanted signals such as computers. If this is not possible, the solution may be switching the microphone system to another radio frequency (see illustration above right).

Electrosmog is generated by electronic equipment such as lighting systems, computers, and other digital equipment. In practice it is advisable to keep as far away as possible from lighting equipment, computers, fax machines, etc., and not to install other electronic equipment in a rack along with the wireless microphone unit. If interference occurs, the usual solution is to switch to another frequency. Apart from intermodulation and digital noise,

the electro-smog inherent in a multichannel system is the sideband noise of the transmitters and receivers. Even the best oscillator is unable to generate a signal entirely without phase shift, consisting of a single, infinitely narrow spectral line. All oscillators have a noise skirt whose spectral density decreases with increasing frequency separation from the line. In the case of carrier signals on adjacent frequencies, the noise skirts and the carriers may overlap. For example, if a performer with a transmitter gets very close to the receiving antenna, it is possible for the sideband noise to open a muted channel. This can be avoided only with the aid of an additional tone-coded squelch circuit.

In practice it is advisable to keep as far away as possible from lighting equipment, and not to install other electronic equipment in a rack along with the wireless microphone unit. If interference occurs, the usual solution is to switch to another frequency.

Where several wireless systems are to be used simultaneously in the same place, interference may result from intermodulations due to the non-linear distortion of combined carrier frequencies (see illustration on the right).

Like most other wireless microphone systems, AKG WMS systems use frequency modulation. This involves changing (modulating) a carrier frequency in step with an audio signal (see also WMS 40, page 9).

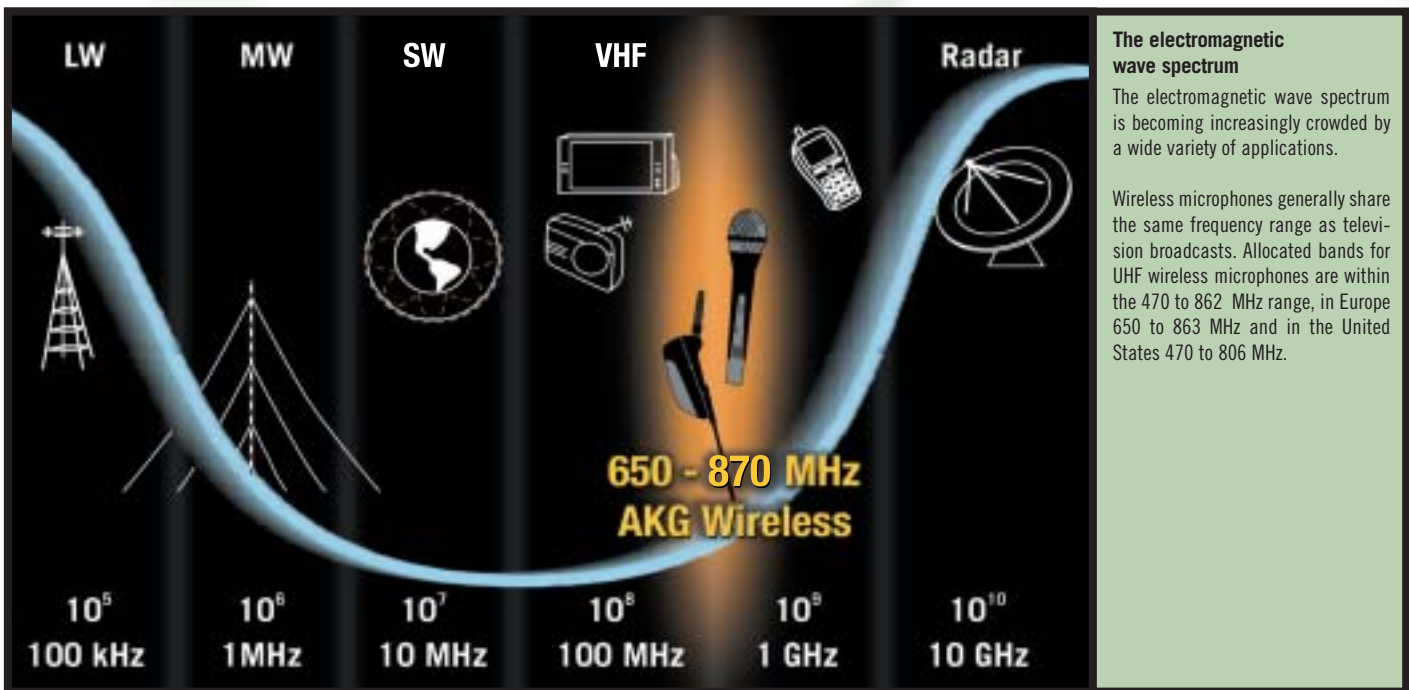

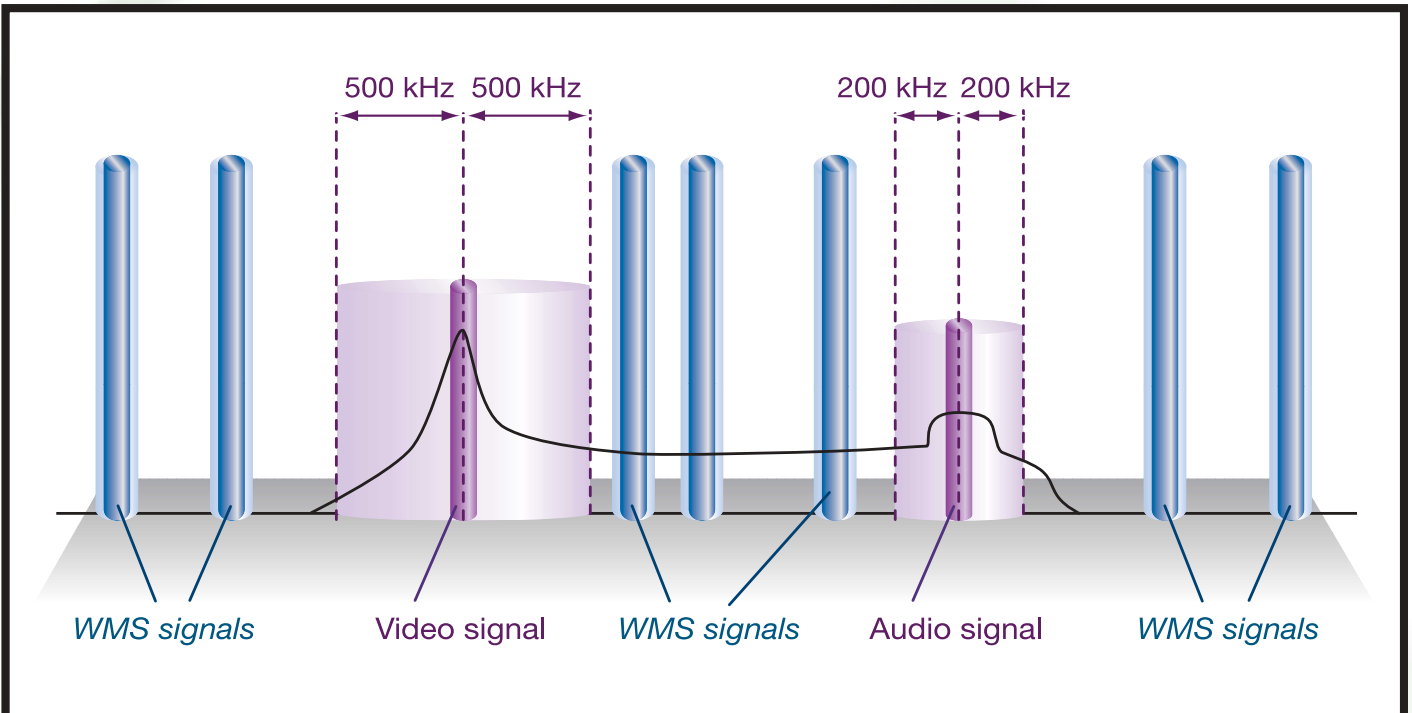

WMS frequency band with TV transmitter

If you are faced with interference caused by a television station, select the carrier frequency of the wireless microphone system such that there is a separation of at least 500 kHz from the video carrier, and 200 kHz from the audio carrier. Caution: changing a single carrier frequency may result in chaotic intermodulation in the entire multichannel system!

The Frequency Management Program from AKG provides a simple solution to this problem as it automatically finds frequencies that will not interfere with one another.

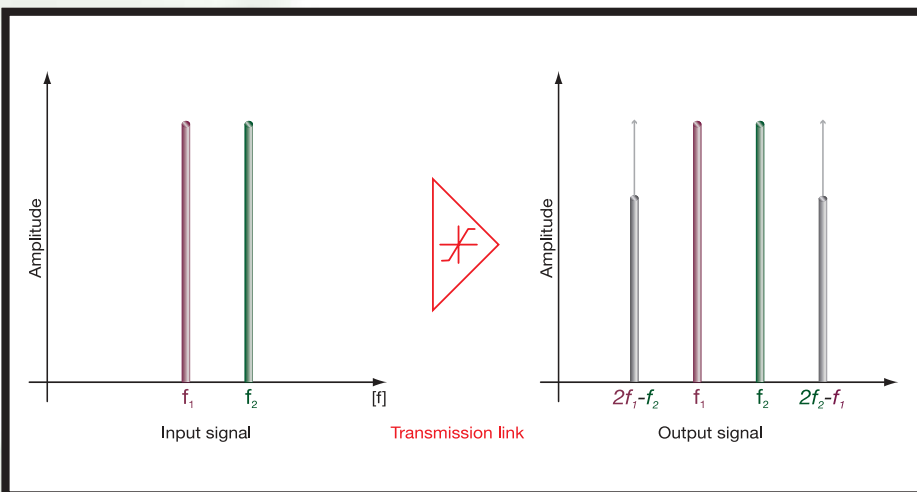

Intermodulation

The nonlinear characteristics of a transmission link may cause intermodulation problems. Intermodulation products do not increase linearly as f_1 and f_2 rise in amplitude of, but significantly faster. 3rd order intermodulation artifacts are the biggest problem that beset wireless systems, as they are strong enough to be clearly received.

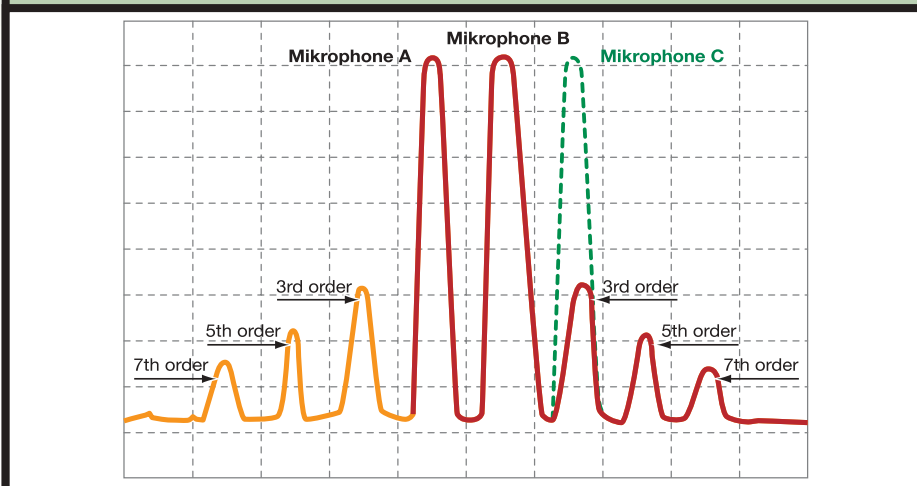

Intermodulation

The simultaneous use of several radio sources results in intermodulation products in the frequency spectrum. If, for example, a third radio source (microphone) is used on the same frequency as that of a 3rd order intermodulation product of microphones A and B, microphone C is very likely to pick up a lot of intermodulation noise. This is why it is essential to test all the radio frequencies you wish to use before each performance.

The Auto Setup function performs this test automatically.

HOW MULTICHANNEL TECHNOLOGY WORKS

FREQUENCY MANAGEMENT, INTERFERENCE, AND PRACTICAL REMEDIES

Interference due to intermodulation can occur as soon as a radio-frequency circuit consisting of semiconductors or ferrites – like that of a WMS receiver – handles several RF signals at different frequencies. The number of disturbing frequencies (intermodulation products) increases exponentially wherever several radio links (frequencies) are used simultaneously. This laws of physics have the biggest impact when several radio microphones are used at the same time. The innumerable new frequencies generated by the combination, addition and subtraction of the desired frequencies cause additional interference. Expert management of the frequencies of all radio sources designed to be used simultaneously is therefore absolutely essential for the problem-free operation of a multichannel wireless system.

Incorrect positioning of the antennas and receiver is just as frequently a source of undesirable interference. It is essential to ensure a minimum distance of 5 feet (1.5 m) from large metal objects such as lighting gantries and stage decorations (especially wire mesh). You should also avoid placing antennas in wall niches to prevent shadowing. Radio signals reflected or shadowed by walls, ceilings or metal structures also weaken the useful signal, thus resulting in improper functioning of the

radio equipment (see WMS 40 illustration on page 6/7). The interference from electrical appliances that cause electrosmog (such as computers and lighting equipment) can be particularly disturbing during deep fades. During a deep fade that changes only slowly, a tone code squelch prevents unwanted noise from lasting too long.

On the other hand, a conventional muting circuit is unable to differentiate between “friend” (the right frequency) and “foe” (unwanted signals). If the level of interference is too high, it may interrupt the audio path during noisy deep fades. Most receivers use both types of circuit: a fast muting circuit to eliminate short bursts of noise, and a tone code squelch to reject persistent noise. Since both types of circuit act like a hard gate on the audio signal, there will always be some residual switching noise.

To ensure problem-free operation, always observe the following basic rules when setting up a multichannel wireless system as opposed to a single channel application. Always position the receiving antennas within the far-near difference range (see page 45). Nevertheless, make sure there is always an unobstructed line of sight between the transmitter and receiver during the performance. Also, the better the

audio signal fed to the transmitter and the higher the signal/noise ratio of the transmitter and receiver, the better your wireless system will work. Basically you should always set the transmitter audio input gain first. The signal-to-noise ratio is the ratio between the amplitude of the wanted signal and the noise amplitude; it is a logarithmic expression for the purity of a signal. With radio transmission, the signal/noise ratio depends on the amplitude of the audio signal. The stronger the audio signal, the better the signal-to-noise ratio. This is why it is always a good idea to make sure not to set the audio input gain of the transmitter too low.

In order to enhance the signal/noise ratio, the audio signal passes through a pre-emphasis circuit in the transmitter and a corresponding de-emphasis circuit in the receiver. The amplitude of the signal is not evenly distributed over the frequency spectrum. Higher frequencies have a lower amplitude than lower frequencies, resulting in a lower signal-to-noise ratio for higher frequencies than for lower ones. FM demodulation generates more high-frequency noise. The pre-emphasis circuit boosts higher frequencies ahead of the radio link, whilst the de-emphasis circuit in the receiver attenuates them by a corresponding amount.

Automatic frequency setup

During concerts and other performances, a number of appliances emit electromagnetic waves that may disrupt your transmission channels (outside interference). Thanks to the “Environment Scan” function, AKG wireless systems are able to localize such “jammers”, switching to suitable interference-free frequencies instead.

In other words, the system automatically searches for gaps in the frequency spectrum – that is, frequencies where no interference is detected – occupying them with its own carrier frequencies.

Important: Run Environment Scan during the soundcheck and note the results. Do another test shortly before the performance, as there will almost certainly be new sources of interference, such as television and radio transmitters, or mobile phones in the audience. This gives you time to correct any problems that may have arisen.

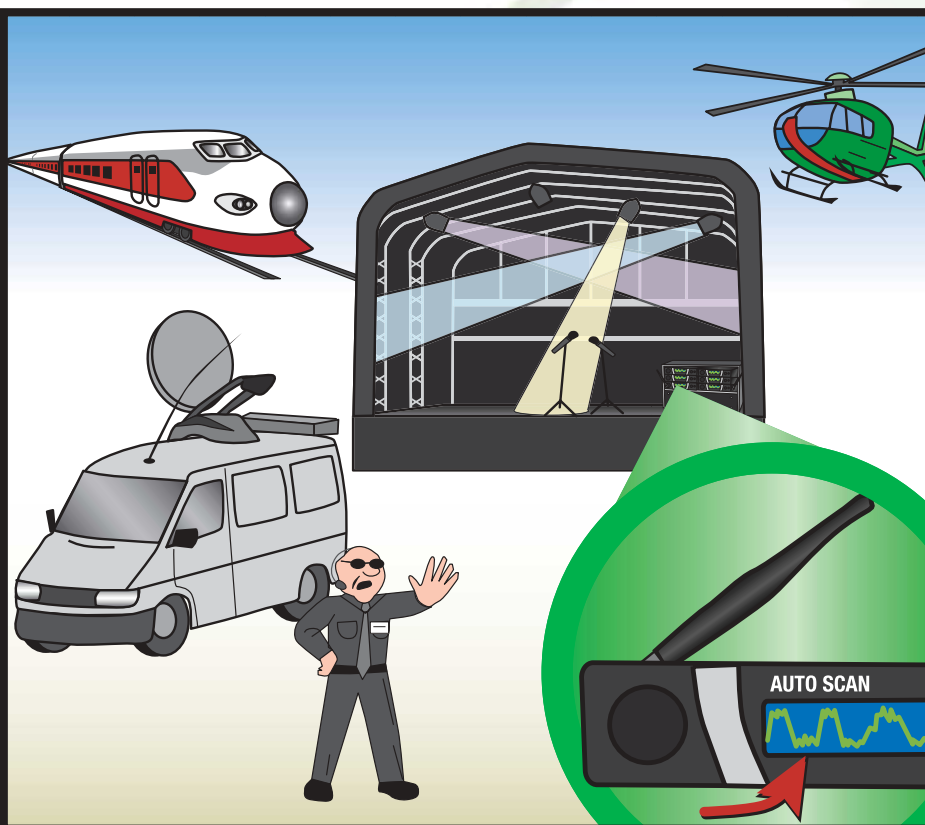

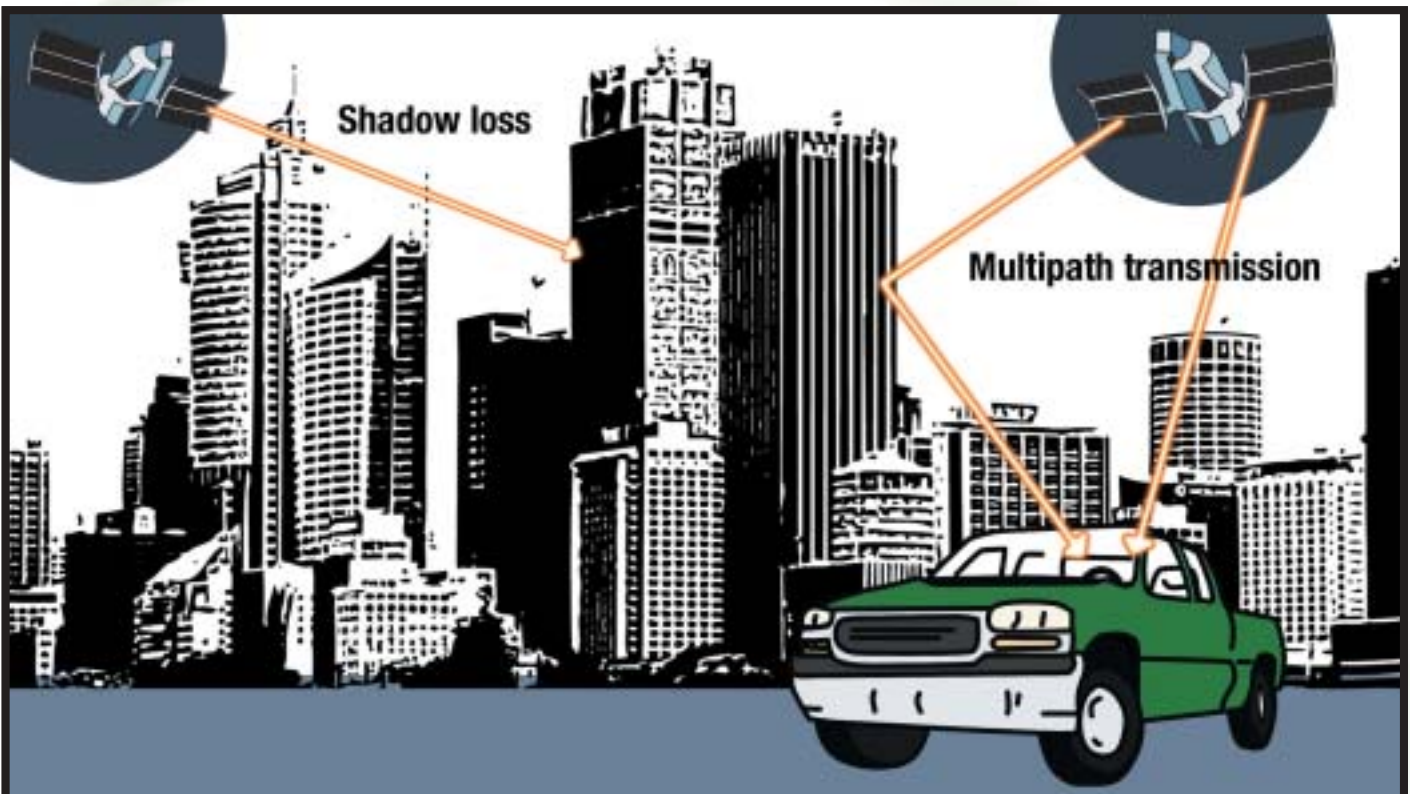

Shadow loss:

Shadow loss means that the signal path from the transmitter to the antenna is interrupted by an obstacle.

Multipath transmission:

A radio signal travels to the receiver not only along the direct path but also along several alternative routes as the signal is reflected off or diffracted around all kinds of structures. So the same signal arrives at the receiver at different points in time and in different conditions.

Diversity systems help to eliminate transmission problems caused by shadow effects or multipath transmission.

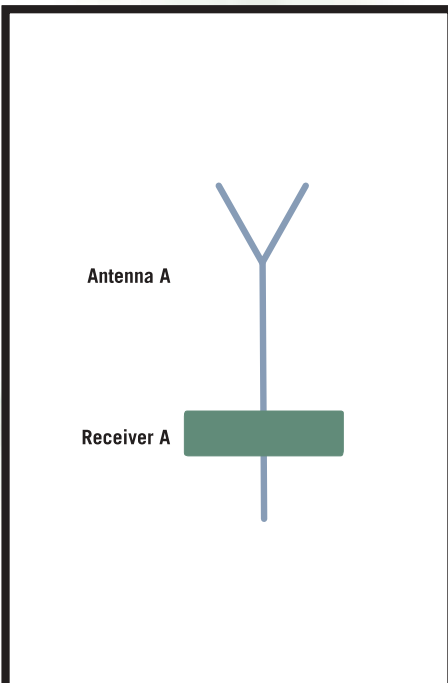

Non Diversity

Wireless systems with a non-diversity receiver have to process the signal in whatever shape it reaches the antenna. Even with moderate distances between transmitter and receiver, this results in more frequent – and therefore very disturbing – periods of signal dropout.

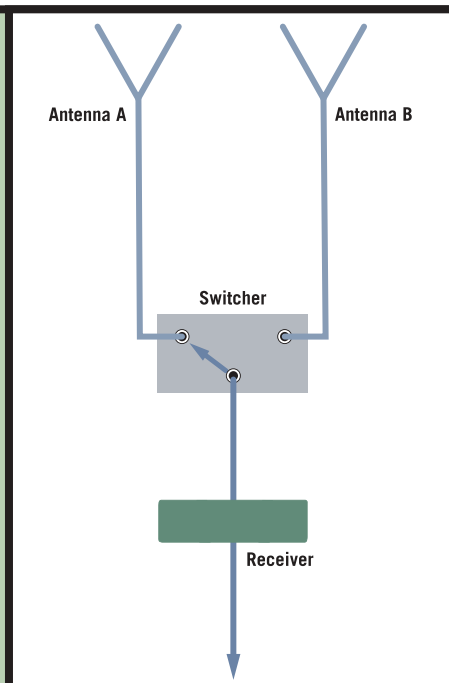

Dual antenna diversity

When the RF signal level of the antenna path being used becomes too low, the switching circuit connects the receiver input to the other antenna. If this fails to provide a higher signal level, the switching circuit reverts to its original position. The disadvantage of this system is that it only checks whether the RF signal level of the second antenna is higher once the level at the first antenna is already too low. Differences in the signal/noise ratio are not even detected at all.

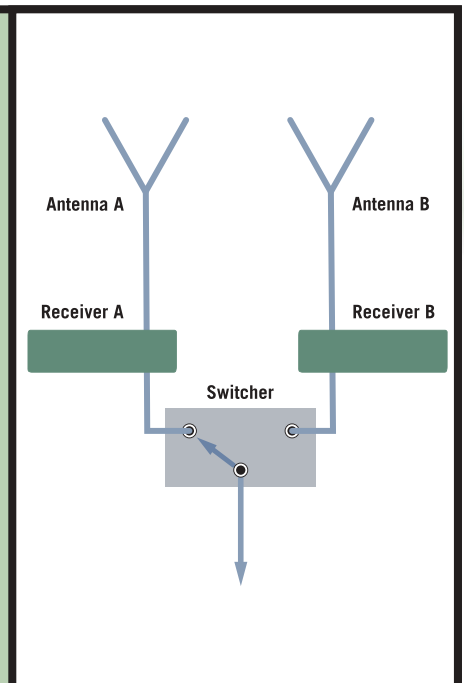

True diversity technology

In contrast to antenna diversity, true diversity not only employs two antennas, but two receivers as well. The switching circuit compares the quality of the two signals and routes the better signal to the output.

HOW MULTICHANNEL TECHNOLOGY WORKS

TROUBLESHOOTING HINTS



Troubleshooting hardwire and wireless microphones				
1. Problem: no sound (microphone does not function)				
Possible cause	Hardwire mic	Wireless system	Remedy (hardwire mic)	Remedy (wireless system)
Power supply	Check whether ... <ul style="list-style-type: none"> phantom power on mixer is on battery is o.k. (C 1000 S only) 	Check whether ... <ul style="list-style-type: none"> power to receiver and transmitter is on and batteries are o.k. 	> Switch phantom power on or replace battery	> Switch power to receiver and transmitter on or replace batteries
Cable/radio link	Check whether ... <ul style="list-style-type: none"> both cable ends are connected 	Check whether ... <ul style="list-style-type: none"> transmitter (mic) and receiver are set to same frequency 	> Connect cable	> Set same frequency on transmitter and receiver
Signal path	Check whether ... <ul style="list-style-type: none"> mic channel is open, mute and preattenuation switches are out, and gain is set correctly on mixer 	Check whether ... <ul style="list-style-type: none"> transmitter signal reaches receiver 	> Open mic channel, set gain to drive input correctly	> Open mic channel, set gain to drive input correctly, set receiver squelch threshold to minimum
2. Problem: poor audio				
Possible cause	Hardwire mic	Wireless system	Remedy (hardwire mic)	Remedy (wireless system)
Weak signal	Check whether ... <ul style="list-style-type: none"> corroded contacts, dry solder joints cause excessive attenuation 	Check whether ... <ul style="list-style-type: none"> transmitter is out of range signal is attenuated by objects or people 	> Clean contacts (use contact spray)	> Reduce distance between transmitter and receiver > Reposition transmitter/receiver (especially antennas) > Use active (directional) antennas > Use booster(s)
Hum, whistle, or other noise	Check whether ... <ul style="list-style-type: none"> stray magnetic fields induce hum in cables (crosstalk from parallel lines), or ground loops, monitors, fluorescent lighting, or transformers degrade the signal 	Check whether ... <ul style="list-style-type: none"> there is intermodulation or interference (spectrum analyzer) signal is jammed by unwanted high-power transmitters (TV/radio station) there are any sources of interferences (computers, lighting, switching power supplies) RF output causes is too high/low 	> Change cable routing > Eliminate interference sources > Keep away from RF sources	> Select other frequencies > Switch off unwanted transmitter (if possible) or increase distance from interference source > Keep away from interference sources > Reduce RF output > Keep transmitter at least 2 feet (1/2 m) away from metal fabric and loose coins
3. Problem: signal quality deteriorates on movement				
Possible cause	Hardwire mic	Wireless system	Remedy (hardwire mic)	Remedy (wireless system)
Dropout or deep fade	Check whether ... <ul style="list-style-type: none"> cable was accidentally disconnected 	Check whether ... <ul style="list-style-type: none"> transmitter is out of range signal is attenuated by objects or people there is a permanent line of sight between transmitter and receiving antennas 	> Fix cable strain relief	> Reposition transmitter/receiver (especially antennas) > Use active (directional) antennas
Extremely inconsistent signal quality	Check whether ... <ul style="list-style-type: none"> any contacts are loose there are any dry solder joints microphone and/or cable is mechanically damaged 	Check whether ... <ul style="list-style-type: none"> transmitter is out of range signal is attenuated by objects or people there are any unwanted local transmitters (e.g. intercom) 	> Repair solder joints and/or equipment	> Switch off unwanted transmitter or increase distance from source of interference > Select clean frequencies > Reposition receiving antennas > Use active (directional) antennas > Use booster(s)

THE WMS 400 MODULAR SYSTEM

MODULAR SOLUTIONS FOR CUSTOM REQUIREMENTS

The requirements of wireless systems vary from one user to another. Every user needs a custom solution, which is why AKG has created the WMS 400 Series, a modular system that offers a wide variety of solutions depending on your taste and preferred applications.

Vocals	<p>Handheld microphone for lead and backing vocals</p> <ul style="list-style-type: none"> • Handheld transmitter with D 880 dynamic or C 900 condenser element • C 900 condenser element offers selectable cardioid and hypercardioid polar patterns • Battery capacity readout • Integrated charging contacts 	 <p>HT 400</p>	 <p>SR 400</p>
	<p>Page 38</p>		

Instruments	<p>WMS 400 guitar system for guitar, bass, and keyboards</p> <ul style="list-style-type: none"> • Extremely rugged, light miniature bodypack transmitter • Mic/line-level input • Lockable on/off switch • Battery capacity readout 	 <p>PT 400</p>	 <p>MK G/L</p>	 <p>SR 400</p>
	<p>Page 39</p>			

Instruments	<p>WMS 400 for accordions, etc.</p> <ul style="list-style-type: none"> • Miniature bodypack transmitter • Integrated charging contacts • Battery capacity readout • Compatible with easy-to-use B 29 L battery supply with 2 in 1 mini mixer 	 <p>PT 400</p>	 <p>2x C 416 L</p>	 <p>B 29 L</p>	 <p>SR 400</p>
	<p>Page 39</p>				

Instruments	<p>WMS 400 for all woodwind and brass instruments</p> <ul style="list-style-type: none"> • Professional mini XLR input • Mic/line-level input with gain control • Lockable on/off switch • Battery capacity readout 	 <p>PT 400</p>	 <p>C 419 L</p>	 <p>D 409 L</p>	 <p>SR 400</p>
	<p>Page 39</p>				

Presenter	<p>WMS 400 presenter system optionally with lavalier or head-worn microphone</p> <ul style="list-style-type: none"> • Extremely rugged, light miniature bodypack transmitter • Input for lavalier or head-worn microphone • Automatic frequency programming via IR • Integrated charging contacts for quick charging • Battery capacity readout 	 <p>PT 400</p>	 <p>C 417 L</p>	 <p>C 444 L</p>	 <p>SR 400</p>
	<p>Page 39</p>				

AKG WMS 400 RECEIVER

THE FIRST STEP TO PROFESSIONAL MULTICHANNEL TECHNOLOGY

The SR 400 true diversity receiver is an optimal solution if you need a reasonably-priced, high-performance multichannel system.

Based on the technology and experience of the revolutionary WMS 4000 wireless system, the SR 400 offers countless features that make setup and operation easier than ever before.

With simultaneous operation of up to 12 channels on each frequency band, you can be certain of smooth operation even in tricky situations in critical RF environments. Thanks to its compatibility with the professional WMS 4000

System, you can set up even complex wireless systems using antenna splitters, power supply units and a whole range of high-performance external antennas.

It has never been easier to set up a professional wireless system in this price bracket than with the WMS 400 system. In Auto Setup mode, the receiver automatically scans the RF environment in the available frequency bands, finds an interference-free channel, and transmits this preset to the associated transmitter by infrared. This makes it possible to set up a multichannel system in just a couple of minutes.

Increased operational reliability and user convenience are ensured especially by the rehearsal function (complete RF testing of all components), clear display of all parameters on a programmable display, an easily visible warning signal with two-color display backlighting, and a low-battery warning on the receiver.

Housed in a rugged half-rack metal case with a host of innovative features, the SR 400 receiver offers all the benefits to make this a top-quality wireless system for both the upcoming star and the price-conscious professional.

Status LEDs

Provide detailed information about the most important system parameters, such as audio level, diversity status, RF level, etc.

Backlit LC display

Gives you a function check at a glance, with two-color backlighting (red/green).

SR 400 Receiver



On/Off switch

Recessed level control

Allows you to adjust the output level, recessed to prevent accidental readjustment.

Infrared interface for transmitter programming

Fast and reliable transmission of frequency settings to prevent misprogramming.

Menu buttons

Facilitate easy programming.

Metal case

Half-rack width for convenient rack installation.

Display Details

- 1 7-level audio bargraph display
- 2 Frequency setup menu with three operating modes: Auto Group, Auto Channel, Preset
- 3 Infrared transmission mode
- 4 Rehearsal function: Rapid check of RF & audio signal quality

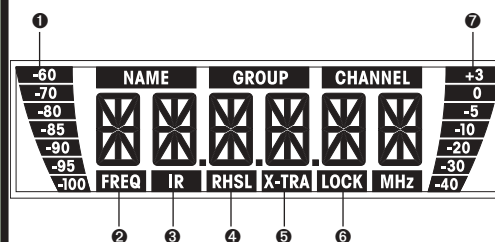

Display Details

- 5 Special functions: receiver name, status display, squelch threshold, system info, etc.
- 6 Lock mode
- 7 Squelch threshold adjustment mode
- 8 7-level RF bargraph display and diversity LEDs

* The maximum number of channels may vary according to local frequency plans.



Auto setup

The receiver is automatically searching for clean frequencies, making system programming quick and easy.



Each Preset contains legal frequencies for a specific country, region, or state

Integrated frequency management database with country coded sets of frequencies for easy frequency selection.



Infrared transmission

The receiver is downloading frequency setup data to the transmitter.



Rehearsal mode

The receiver is recording dropouts and related parameters as the transmitter is moved about the performance area.



System status

If, for instance, the transmitter batteries are running low, the display backlighting will change to red, reminding you that the system needs your attention.



Antenna input socket

Allow you to connect plug-in antennas, remote antennas, or even a complex antenna network.

XLR audio output

Professional balanced XLR output connector.

Audio output jack

Professional unbalanced output jack.

Lockable DC input

Ensures reliable connection to the power supply, with a lock to prevent accidental disconnection.



Range of accessories for complex applications

Thanks to its compatibility with the WMS 4000 wireless system, there is a wide range of accessories available for setting up complex multichannel systems. These include the PS 4000 antenna splitter, the PSU 4000 power supply unit, active and passive antennas with a variety of polar patterns, antenna boosters and remote power supplies, and the HPA 40 headphone amplifier. WMS 4000 Series transmitters also work perfectly with an SR 400.



AKG WMS 400 TRANSMITTERS

HANDHELD AND BODYPACK TRANSMITTERS FOR EVERY CONCEIVABLE APPLICATION

The HT 400 handheld and the PT 400 bodypack are high-performance, compact wireless transmitters that can be used for every conceivable application. Many innovative features not only ensure greater reliability of operation, but also provide extremely convenient operation.

An LC display provides information at a glance about important parameters such as frequency/Preset name (country code),

remaining battery life, low battery warning, and current transmission mode.

Once you have set a frequency on the receiver, an infrared transmission link will feed the related data to the assigned transmitter within seconds, making the setting up of large multichannel systems child's play.

The HT 400 handheld transmitter is available with either a dynamic or a condenser

microphone element. A noiseless On/Mute/Off switch and status LED provide additional user convenience.

The PT 400 bodypack transmitter has a rugged metal case with a mini XLR socket that allows you to connect a wide variety of microphones and instruments. It also has a jack for connecting an external mute switch – a particularly useful feature when the transmitter is inaccessible.

Extremely rugged spring steel mesh grill

Protects the microphone capsule underneath in tough stage acts and live performances.

Infrared sensor

Makes child's play of transmitter programming by downloading frequency and gain settings from the receiver via infrared.

On-Mute/Program-Off switch

A recessed mode switch prevents accidental mode switching.

Soft-touch enamel finish

Adds to handling noise rejection.

Charging contacts

Convenient plug-in charging on the CU 400 charger is environmentally friendly and saves money.

Battery compartment

The transmitter can be powered by a single AA size dry or rechargeable battery.

Display

Shows the selected frequency/ preset and remaining battery life.

Input gain control





Allows you to adjust the gain of the audio input stage.

Interchangeable, color code strips you can write on

For convenient transmitter identification on multichannel systems.

HT 400 Handheld transmitter



<p>PPC 1000 Polar Pattern Converter</p>  	<p>PPC 1000 and PB 1000 for the C 900</p> <p>You can quickly change the polar pattern of the C 900 from cardioid to hypercardioid by attaching the supplied PPC 1000 Polar Pattern Converter (left) to the capsule. Also supplied with the C 900, the PB 1000 Presence Boost Adapter (right) provides a 3 to 5 dB presence rise between 5 kHz and 9 kHz for better intelligibility and a more sparkling instrument sound.</p>	<p>PB 1000 Presence Boost Adapter</p>  
-----------------------------------------------------------------------------------------------------------------------------------------------------------------------------------------------------------------	--------------------------------------------------------------------------------------------------------------------------------------------------------------------------------------------------------------------------------------------------------------------------------------------------------------------------------------------------------------------------------------------------------------------------------------	-------------------------------------------------------------------------------------------------------------------------------------------------------------------------------------------------------------------

Microphones for PT 400

C 411 L C 416 L C 417 L C 419 L C 420 L C 444 L CK 77 WR L CK 77 WR L/P CK 97-C/L D 409 L MK GL CK 55 L LM 3 L C 477 WR L



For hints on how to use MicroMic Series products refer to pages 80 and 81.

Flexible Antenna

Maximum transmission reliability depends on a direct line of sight from the transmitter to the receiver. So be sure never to cover the antenna with clothes or makeup.

Rugged mini XLR connector

Professional 3-pin mini XLR input for connecting MicroMic Series or other head-worn microphones, lavalier microphones, or instrument cables from AKG.

PT 400 Portable transmitter

Soft-touch finish

Soft-touch enamel reduces handling noise.

Infrared Sensor

Setting up the transmitter is incredibly easy as frequency and gain data is downloaded from the receiver via infrared transmission.

Input gain control

Sets the gain of the audio input stage.

Display

Indicates the selected frequency or preset as well as the remaining battery capacity in hours.

Detachable belt clip

0,1 " jack for external mute switch

An external mute switch allows the user to mute the signal even if the transmitter is hidden beneath clothes.

Interchangeable color code labels

For identifying multichannel system transmitters.

Charging contacts

Convenient plug-in charging on the CU 400 charger is cost efficient and friendly to the environment.

Battery compartment

The transmitter can be powered by a single AA size dry or rechargeable battery.



Frequency is being downloaded from the receiver



Frequency preset



Frequency in MHz



Battery status display

LCD display

The LCD on the HT/PT 400 provides a clear readout of the most important transmitter parameters. As soon as the battery capacity drops to a critical level, a warning will appear in the display. Simultaneously, the receiver will display the same warning and change the display backlighting to red.



Low battery capacity warning

THE AKG WMS 400 SERIES CHARGER

THE USER FRIENDLY QUICK CHARGER

Any wireless microphone system depends on sufficiently charged batteries in all the transmitters. There is nothing more embarrassing than a transmitter running out of juice in the middle of the show, or a voice fading as the transmitter battery dies.

Although the battery status indicators and warning lights on the WMS 400 transmitters and receiver alert you to a dying battery ahead of

time, it is still a good idea to use fresh dry or fully charged rechargeable batteries.

However, the setup phase and the soundcheck already use up some of each transmitter battery's capacity, so the batteries need to be topped up before the show. Obviously, there is not enough time to use a conventional charger, let alone take the transmitters apart to get at the batteries inside their compartments.

The CU 400 puts an end to this kind of hassle. It can charge two batteries simultaneously to full capacity within less than two hours, and there is no risk of overcharging the batteries.

And what's more, you can leave the batteries inside the transmitters. The transmitters and charger use integrated charging contacts so all you have to do is plug the transmitters into the CU 400 and remove them after charging.

CU 400 Charging unit



2 universal charging slots

Accommodate HT 400 and PT 400 transmitters, or replacement battery packs.

Locking DC jack

Input jack for a local or central power supply (e.g., PSU 4000).

Charging status LEDs



Integrated charging contacts for direct charging

Both the HT 400 and the PT 400 provide integrated bottom panel charging contacts. To get the batteries fully charged in less than two hours, just plug the transmitters into the CU 400. A single CU 400 can charge two transmitters simultaneously, making it easy to restore even a large number of transmitters to maximum performance within a short time.





SRA 1 – Passive wideband directional antenna

- For indoor and outdoor use, specifically for setting up long-range radio links
- For use with short antenna cables up to 5 m (16 ft) long



SRA 2B – Active wideband directional antenna

- For indoor and outdoor use, in particular for setting up radio links for distances up to 300 m (1000 ft)
- Integrated high-performance antenna booster for use with antenna cables up to 200 m (655 ft) long (RG 213, in conjunction with 2 x AB 4000)
- Remote powering option, status LED
- Rugged water-resistant case with BNC output
- Optional laser positioning pointer



RA 4000 B – Omnidirectional wideband booster antenna

- For indoor and outdoor use, in particular for near-field antenna setups with no preferred direction
- Integrated high-performance antenna booster for use with antenna cables up to 180 m (600 ft) long (RG 213, in conjunction with 2 x AB 4000)
- Remote powering option, status LED
- Rugged water-resistant case with BNC output



AB 4000 – Antenna booster

- Ultralinear antenna booster with water-resistant case
- BNC or N inputs and outputs, DC input, status LED



HT 4000

- Wideband UHF handheld transmitter with interchangeable microphone elements and metal die-cast body
- Preprogrammed factory presets
- Up to 24 intermodulation-free frequency groups in each 30 MHz wide UHF band
- Over 15 hours continuous operation on 2 AA size alkaline batteries or a minimum of 12 hours on optional BP 4000 battery pack



PT 4000

- UHF bodypack transmitter with magnesium body
- 1200 selectable frequencies in 30 MHz band
- Backlit display and jog switch operation
- Up to 30 mW RF output for reliable transmission
- Optional remote mute switch
- Operates for up to 15 hours on AA batteries, 12 hours on optional BP 4000 battery pack, and displays remaining battery life



PS 4000

- Expandable modular antenna splitter with metal case
- 220 MHz bandwidth for use with all WMS 4000 channels
- Adjustable cable length compensation
- For multi-room installation of antenna systems



PSU 4000 Central power supply unit

- Powers up to 12 SR 4000 receivers plus antennas via 3 PS 4000 antenna splitters, or three CU 4000 charging units
- Also powers the HPA 4000 headphone amplifier or HUB 4000 network concentrator



HPA 4000 Headphone amplifier

- For connecting up to 8 SR 4000 receivers

SETTING UP MULTICHANNEL SYSTEMS

HOW TO DEAL WITH INTERMODULATION AND KEEP YOUR FREQUENCIES STRAIGHT

Whenever two or more signals are transmitted by a non-ideal system, undesired intermodulation products will be created, causing distortions (see also WMS 400, p. 31). An ideal system would deliver an output signal that is identical to the input signal over the whole frequency range even at larger amplitudes, and no problems would arise.

In practice, however, ideal systems do not exist, as transistors in particular have only a relatively narrow linear gain range. This is why the transmission of several signals via nonlinear systems, such as transmitters and receivers, will result in unwanted arti-

facts generated by intermodulation. These intermodulation products have to be dealt with somehow in practice.

The order of intermodulation products depends on the nonlinearity of the system response curve; the amplitudes of intermodulation products will always grow in proportion to the product of the mathematical powers of the fundamental signals generating a given intermodulation product. In reality, third-order intermodulation products tend to be particularly troublesome because they rise much more rapidly than the fundamental signal, thus turning into real, i.e., audible noise.

Whenever the frequency of the desired signal coincides with that of an intermodulation product the signal will be distorted. Moreover, the intermodulation product may activate the receiver's squelch function if the amplitude of the intermodulation frequencies exceeds the squelch threshold.

Obviously, the effective impact of intermodulation distortion also depends on the distance between transmitter and receiving antenna. In the case of wireless microphones transmitting on an intermodulation frequency, the desired signal is often ruined by intermodulation distortion if you move the transmitter too far away from the receiver.

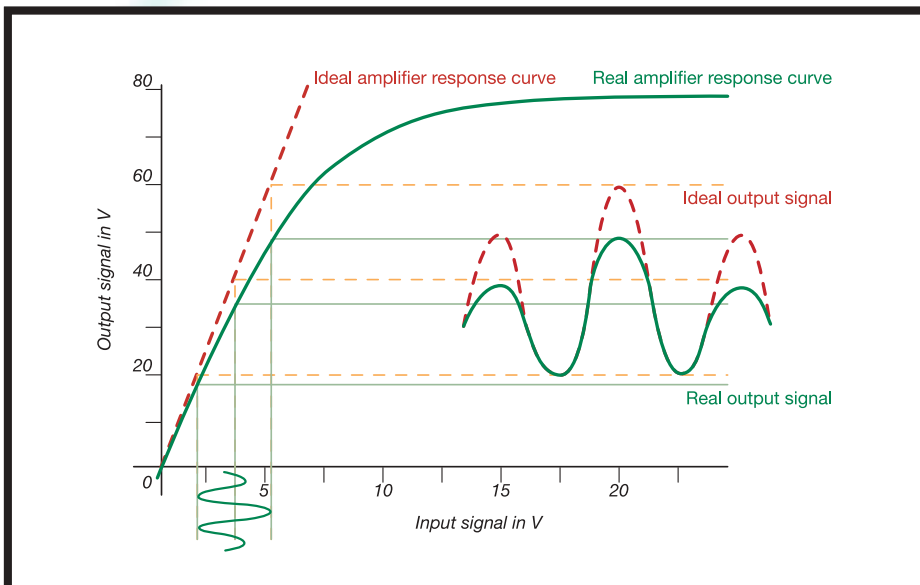

Ideal and real gain curves of ideal and real amplifiers

High audio input levels may overload the amplifier, so the peaks of the amplified signal are clipped as a result of saturation. The compression characteristic may be described by a polynomial (i.e., the sum of multiples of powers of a variable X). This polynomial includes all powers, with the odd powers (3, 5, 7, ...) responsible for intermodulation in multichannel systems. Because of its high coefficient, the third power term is especially important which is why third-order intermodulation products are dominant. The reciprocal value of the third-order coefficient defines the IP 3 Intercept (see below), which is the most important parameter for the intermodulation resistance of an RF amplifier. A smaller third-order coefficient of the transmission polynomial means a higher IP 3, which implies greater linearity of the RF amplifier and thus better resistance to intermodulation distortion.

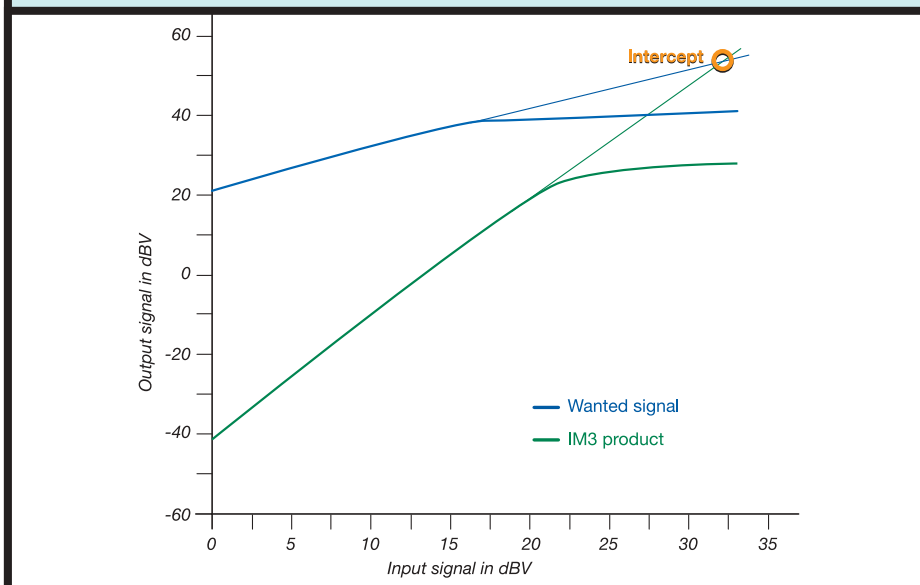

IP 3 Intercept

The Intercept marks the intersection of the theoretical linear transfer curve for the wanted signal's amplifier response curve and the theoretical linear transfer curve for the third-order intermodulation product. It is never actually reached because the amplifier will compress the wanted signal before it reaches the IP 3 Intercept level.

The higher the Intercept of a radio transmission system, the lower the IM risk, and the more channels may be used within a given frequency band.



Microphone A carrier frequency
Spectrum analyzer trace

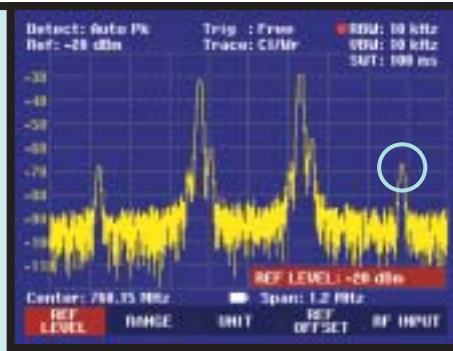

Intermodulation of carrier frequencies A and B
The trace clearly shows that third-order intermodulation products are only 38 dB lower in level than the carrier frequencies.

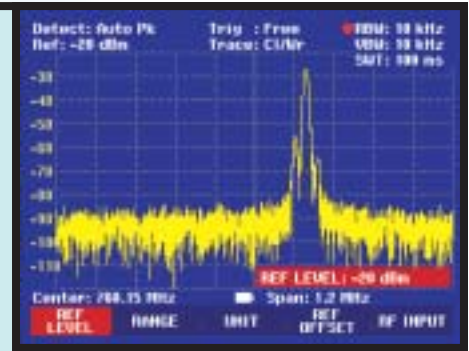

Microphone B carrier frequency
Spectrum analyzer trace

Intermodulation trace on a spectrum analyzer display
Third-order intermodulation products from three carrier frequencies.

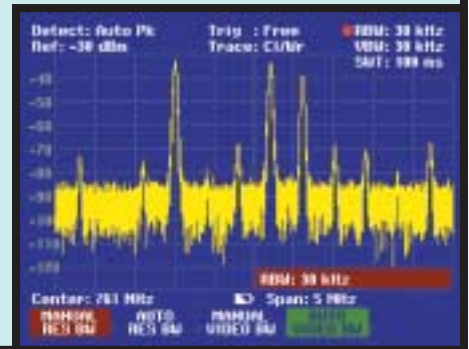

The received signal level declines in proportion to the square of the distance between transmitter and receiver, and the intermodulation level produced in the receiver declines in proportion to the third power of the received signal level. This implies that intermodulation declines exponentially, in proportion to the sixth power of the distance between transmitter and receiver. If the distance is longer than 66 feet (20 m), receiver intermodulation is drowned out by noise. What remains is another important type of intermodulation distortion that has not yet been mentioned: transmitter intermodulation. In this case, the intermodulation products are not generated in the receiver, but in the transmitters, and are radiated by them along with the desired

carrier frequencies. This will only happen, however, if there is enough crosstalk of carrier frequencies between two neighboring transmitters that intermodulate with each other. In this case, the antenna of one transmitter receives the carrier signal of a neighboring transmitter. If this signal makes it into the non-linear output stage of the transmitter, the first harmonic of the desired signal will transform it into a signal whose frequency is indistinguishable from the receiver intermodulation. The same happens in the other transmitter that will generate a mirror-image intermodulation product. Curiously, a love duet close to the receiving antennas may lead to intermodulation distortion caused by the nonlinear receiver. If the two singers move away, the

intermodulation remains unchanged, but is now produced in the transmitters. In large multichannel systems, reducing the RF output of the transmitters is a way to bring down transmitter intermodulation by minimizing the nonlinear response of the transmitter's output stage. The RF output of WMS 4000 transmitters, for example, can be reduced from 50 mW to 10 mW (ERP –Equivalent Radiated Power).

Here are some hints on how to minimize receiver intermodulation:

Always lay out the antenna system so as to ensure reliable transmission from every point on the stage. Moreover, be sure to use only the types of cables recommended in the user's manual. The distance between transmitters and active antennas should be at least 15 feet (5 m) (see also Antenna Position Check Applet on p. 45). Increasing the input attenuation of the antenna system helps, as does reducing the transmitter RF output to 10 mW. The latter has proved particularly useful for hand-held transmitters in situations where range is not an important consideration; generally, the RF output level used should always be just high enough to ensure adequate transmission. Systems with a higher transmitter RF output (ERP) are more prone to intermodulation problems, but this is compensated for by their better resistance to electrosmog.

When multichannel systems are used on Broadway, for instance, only the strongest will survive.

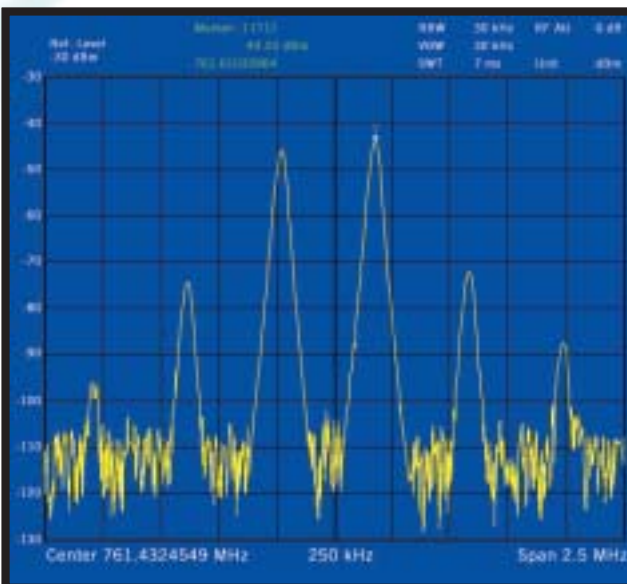

Intermodulation trace on a spectrum analyzer display
Intermodulation products from 2 carrier frequencies, 3rd-order IMD and 5th-order IMD.

SETTING UP MULTICHANNEL SYSTEMS

HOW TO DEAL WITH INTERMODULATION AND KEEP YOUR FREQUENCIES STRAIGHT

Frequency Management: a good idea for any multichannel system

One way to run a multichannel system would be to hire an RF engineer with a university degree for doing nothing but the number crunching required for finding clean frequencies and keeping an eye on all the batteries in the system. Unfortunately, it is not easy to find someone with this kind of knowledge, and then these experts are extremely busy and expensive.

Don't worry, there is an easier way. WMS Series wireless systems from AKG provide both an integrated Frequency Management System and clear battery status readouts to remove the hassle from setting up and operating a multichannel system and save time and money.

Calculation of intermodulation products

$$f_{IM} = | m_1 f_1 + m_2 f_2 + m_3 f_3 + m_4 f_4 + \dots |$$

$$m_v = 0, \pm 1, \pm 2, \pm 3, \pm 4, \dots$$

The order of IM products depends on the non-linearity of the transfer characteristic.

$$f_{IM} = | 2 f_1 \pm f_2 |, \quad f_{IM} = | f_1 \pm f_2 \pm f_3 | \quad 3^{rd} \text{ order}$$

Derivation of 3rd order intermodulation products

$$\begin{aligned} (\cos \omega_1 t + \cos \omega_2 t + \cos \omega_3 t)^3 = & \left(\frac{e^{j\omega_1 t} + e^{-j\omega_1 t}}{2} \right)^3 + \left(\frac{e^{j\omega_2 t} + e^{-j\omega_2 t}}{2} \right)^3 + \left(\frac{e^{j\omega_3 t} + e^{-j\omega_3 t}}{2} \right)^3 \\ & + 3 \left(\frac{e^{j\omega_1 t} + e^{-j\omega_1 t}}{2} \right)^2 \frac{e^{j\omega_2 t} + e^{-j\omega_2 t}}{2} + 3 \left(\frac{e^{j\omega_1 t} + e^{-j\omega_1 t}}{2} \right)^2 \frac{e^{j\omega_3 t} + e^{-j\omega_3 t}}{2} \\ & + 3 \left(\frac{e^{j\omega_2 t} + e^{-j\omega_2 t}}{2} \right)^2 \frac{e^{j\omega_1 t} + e^{-j\omega_1 t}}{2} + 3 \left(\frac{e^{j\omega_2 t} + e^{-j\omega_2 t}}{2} \right)^2 \frac{e^{j\omega_3 t} + e^{-j\omega_3 t}}{2} \\ & + 3 \left(\frac{e^{j\omega_3 t} + e^{-j\omega_3 t}}{2} \right)^2 \frac{e^{j\omega_1 t} + e^{-j\omega_1 t}}{2} + 3 \left(\frac{e^{j\omega_3 t} + e^{-j\omega_3 t}}{2} \right)^2 \frac{e^{j\omega_2 t} + e^{-j\omega_2 t}}{2} \\ & + 6 \frac{e^{j\omega_1 t} + e^{-j\omega_1 t}}{2} \frac{e^{j\omega_2 t} + e^{-j\omega_2 t}}{2} \frac{e^{j\omega_3 t} + e^{-j\omega_3 t}}{2} \end{aligned}$$

Dual-tone products are obtained from lines 1 through 4,

$$\text{e.g., } | f_{IM} = 2f_1 - f_2 |$$

Three-tone products are obtained from line 5,

$$\text{e.g., } | f_{IM} = f_1 + f_2 - f_3 |$$

The far-near difference

Unlike a hardwire microphone, even the best wireless system is susceptible to dropouts because the relative positions of persons and objects within the coverage area will change constantly during an event. At any moment, shadow loss and signal cancellation may coincide with intermodulation and sideband noise in such a way as to cause a dropout. The specified dropout probability under such conditions for the WMS 4000 is less than 0.1%.

This is equivalent to a downtime of one third of a second per hour. Noticing such short interruptions is difficult even for an experienced tonmeister.

However, this low dropout probability can only be achieved inside a Faraday cage in which no other RF or digital equipment is used along with the WMS 4000.

As mentioned above, the dropout probability or immunity to interference depends primarily on the antenna positions. Finding the best antenna locations is always a balancing act. If the antenna is too far away from the stage the received signal will be too weak and drowned out by receiver self-noise and other unwanted disturbances during a deep fade. If you install the antenna too close to or even on the stage, however, the dreaded intermodulation whistles

generated by the receivers and transmitters may become audible.

Here is where the far-near difference comes in. It is the difference between the receiving antenna's distance from the rearmost point on the stage where a transmitter will be used and the receiving antenna's distance from the front edge of the stage.

The Applet <http://www.akgfrequency.at/antennaposition/> allows you to compute optimum antenna positions from known far-near differences.

To ensure intermodulation-free multichannel operation, AKG programs sets of frequency presets into each WMS 4000 system. Each preset contains groups of frequencies that do not disturb one another by intermodulation.

Depending on local frequency plans, up to 18 channels can be used simultaneously within each 30 MHz subband. "Enhanced-security presets" with 14 channels or less within the respective 30 MHz subbands are available for some countries.

Although all the frequencies of any preset are approved for use in the respective country, you are still required by law to obtain a permit from the local authorities before you can use the system.

Adding channels by duplicating an existing frequency structure

Here is a proven way to add clean frequencies:

1. Refer to the Theater Frequencies table below and start with a frequency group you are using on stage A, for instance, Band I with 18 subchannels.
2. Add to each frequency half the minimum channel spacing. (In this example, the minimum channel spacing for a group of 18 frequencies is 300 kHz, one half of that being 150 kHz.) The resulting group for use on stage B (Band I + 0.15 in the table below) has the same properties as the original group.

Provided the two rooms are separated by a brick wall at least 8 inches (20 cm) thick, you can use the new frequency group you derived by adding 150 kHz without risking intermodulation distortion. By repeating this procedure for the other two frequency groups used on stage A, you will obtain the table shown below with 108 subchannels in Bands I, II, and V.

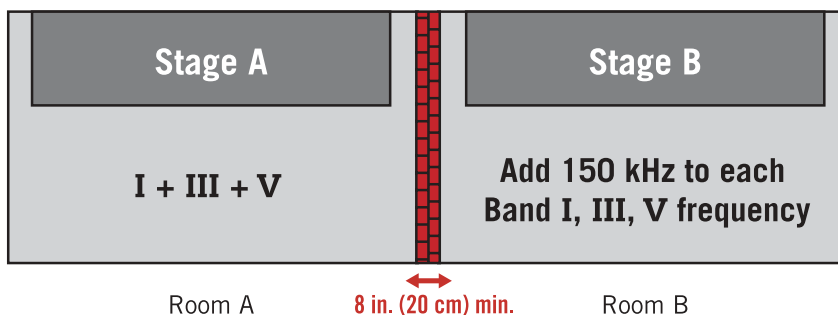

Theater Frequencies

	Stage A			Stage B		
	AT 1 preset frequencies			AT 1 preset frequencies increased by 150 kHz (0.15 MHz)		
	Band I	Band III	Band V	Band I + 0,15	Band III + 0,15	Band V + 0,15
1	650.850	720.700	790.900	651	720.85	791.05
2	651.350	721.200	791.400	651.5	721.35	791.55
3	654.850	724.700	794.900	655	724.85	795.05
4	656.350	726.200	796.400	656.5	726.35	796.55
5	667.950	737.800	808.000	668.1	737.95	808.15
6	673.250	743.100	813.300	673.4	743.25	813.45
7	650.150	720.000	790.200	650.3	720.15	790.35
8	665.050	734.900	805.100	665.2	735.05	805.25
9	666.050	735.900	806.100	666.2	736.05	806.25
10	675.450	745.300	815.500	675.6	745.45	815.65
11	672.450	742.300	812.500	672.6	742.45	812.65
12	676.050	745.900	816.100	676.2	746.05	816.25
13	650.450	720.300	790.500	650.6	720.45	790.65
14	652.450	722.300	792.500	652.6	722.45	792.65
15	658.150	728.000	798.200	658.3	728.15	798.35
16	661.950	731.800	802.000	662.1	731.95	802.15
17	663.350	733.200	803.400	663.5	733.35	803.55
18	671.150	741.000	811.200	671.3	741.15	811.35

SETTING UP MULTICHANNEL SYSTEMS

MODULAR SOLUTIONS FOR PROFESSIONAL REQUIREMENTS

Calculating intermodulation-free radio frequencies requires an enormous amount of computing power. AKG used up to 150 computers operating day and night to calculate new sets of carrier frequencies

unless the computers were needed for other purposes. The results are available to all users of AKG wireless systems on the Internet at www.akg.com/frequencies. The Frequency Management Program available

on the AKG homepage lets you check all the radio frequencies you are planning to use for compatibility, making it easy to set up an AKG multichannel system that works perfectly from the start.



www.akgfrequency.at

The AKG Frequency Management Program checks all the radio links you are planning to use for compatibility and potential intermodulation problems.

To make sure your wireless system will operate smoothly, we recommend checking both the frequencies your system is going to use and the frequencies of local radio and TV stations, etc. with this program before setting up the system.

Frequency bands

Each of the six bands contains legal frequencies and presets for reliable, intermodulation-free operation. Special frequency versions within each band are available on request. An optional programmer allows AKG staff to program these frequencies either on location (one user preset) or at your local AKG Service Center (all presets).

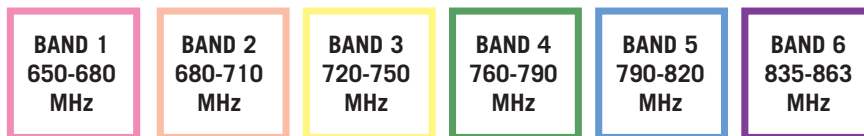

RF output (ERP)

The HT 4000 and PT 4000 transmitters are available in three different RF output versions. Each transmitter is delivered with the maximum RF output (ERP) approved for the country or region where it will be used. The RF output of a transmitter can be changed, but this can only be done by AKG Vienna.

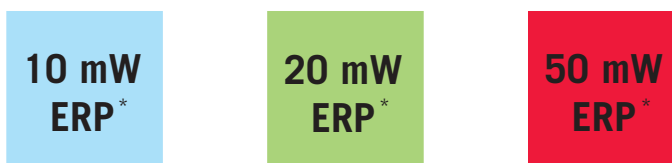

* ERP = Equivalent Radiated Power

Multichannel example 1

Each frequency band is 30 MHz wide and comprises up to 18 intermodulation-free frequencies (depending on local frequency plans). If you need more than 18 frequencies, you can use several bands. Make sure to select bands with the widest possible frequency spacing between them.



Multichannel example 2

Where local frequency plans limit the available frequency range to two bands, you can still set up a large multichannel system. Bands 1 and 2 together provide about 25 usable frequencies in this example. Again, use bands with the widest possible spacing between them!



** depending on optimum antenna placement

HOW TO USE ANTENNAS

SELECTING, PLACING AND USING ANTENNAS

Any radio system uses antennas to get a signal from one place to another. To ensure the best possible signal quality, it is imperative to select the optimum antennas for the system and place the antennas correctly. Reflections, shadow loss, or deep fades may weaken or even cancel the radio signal (drop-out). If you obey a few simple rules for placing your antennas, transmitters, and receivers, your system will operate smoothly.

Absorption by or reflections off metal grid structures, the audience, and the musicians on stage (see illustration below) will attenuate any radio signal.

For best results, place the receiver near the stage but at least 5 feet (1.5 m) away from any metal beams, spotlights, lighting control consoles, computers, or other digital equipment. Make sure the transmitter will always be at least 21 feet (7 m) away from the receiver (see Antenna Position Check Applet on page 45). Since UHF signals propagate in a similar way to light, always keep a direct line of sight between the transmitter and receiver.

Antennas, like microphones, have different polar patterns. Depending on the venue and type of system, you may need directional antennas, such as Yagi (cardioid to hypercardioid) or log periodic (shotgun) types, or omnidirectional antennas with no preferred

direction. Directional antennas are usually the best bet where the transmitters will only be used within a relatively small area, e.g., on a stage. Directional antennas can be used to overcome long distances or reject unwanted signals from off-axis directions. This is why they are very popular for open-air events. The greatest benefit of directional antennas – provided their gain is high enough – is that you can place them far enough from the stage that all transmitters appear to be at the same distance from the antenna. This prevents transmitters nearer to an antenna from generating intermodulation products that may interfere with the weaker signals from more distant transmitters. Use active omnidirectional antennas in rooms that are too small for directional antennas. We recommend mounting the two antennas vertically polarized and as high as possible above the performers.

Select your antenna cables very carefully, too. The antenna cable must feed the output signal of a remote antenna to the receiver. Note that any antenna cable will attenuate the signal it carries (cable attenuation). Different types of cable have different amounts of attenuation so which type works best depends on the length of the cable run. So if you need very long antenna cables, go for a low-attenuation type even though it will be thicker and more expensive than high-attenuation cable.

To compensate for the attenuation of long antenna cables, use either active antennas or in-line boosters. In many situations, though, you may be able to save on active antenna components by using the next-higher (slightly more costly) grade of cable. Using the optimum type of antenna cable may be the key to a smoothly working wireless system and helps reduce the levels of cost, stress, and aggravation.

Large open-air festivals are one example where antenna placement is of paramount importance because the transmitters are usually far away from the antennas, and more often than not there will be other radio links (radio or TV station O/B vans, etc.) to deal with as well. We recommend using directional antennas, and don't be a miser when it comes to buying antenna cable!

The only way to maintain good signal quality over long cable runs is to use expensive, high quality antenna cable, e.g., a type with a foam dielectric. A booster such as the AKG AB 4000 can compensate for 17 dB of cable attenuation, allowing you to add another 200 feet (60 m) or so of RG 213 cable to your antenna line. For extremely long lines, you can even use two boosters in series. If you have to route the antenna cables through a cable duct that may be prone to RF interference, use double-shielded cable.

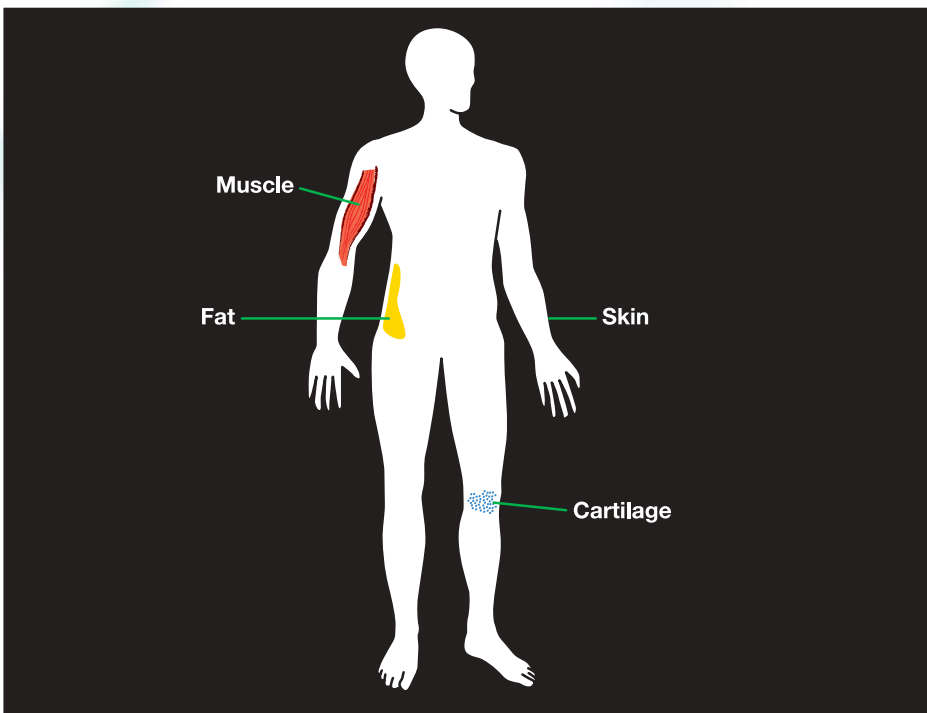

Signal loss caused by the audience

The human body reflects and weakens radio signals. One problem that has plagued cellular telephone systems is the absorption of microwaves by human body tissues. Similar to the reverberation time, the RF level in a room decreases as the room becomes more crowded and absorption increases.

Even if there is a line of sight between the transmitter and receiver, the audience in between will weaken the RF signal because part of the RF energy hits the people and is absorbed by their body tissues. We therefore recommend placing the antennas so that the line of sight will be at least 3 1/2 feet (1 m) above the audience's heads to reduce this absorption effect.

Penetration depth in human body tissues for 4.3 dB attenuation:

Skin	4.3 mm
Fat	10.4 mm
Muscle	2.8 mm
Cartilage	21.0 mm

HOW TO USE ANTENNAS

SELECTING, PLACING, AND USING ANTENNAS

Cable attenuation setting vs. cable length in complex systems

The CLA cable attenuation setting on the booster(s) and antenna splitter(s) depends on the frequency band, antenna type, cable type, cable length, and the position of the cable within the antenna line.

For details on setting up an antenna network refer to the PS 4000 manual.

Frequency bands I + II	Cable position A SRA2B > AB 4000 or PS 4000			Cable position A RA 4000 B > AB 4000 or PS 4000			Cable position A SRA1 > AB 4000 or PS 4000			Cable position B AB 4000 > AB 4000 or PS 4000		
	RG 58 (m)	RG 213 (m)	CLA setting (dB)	RG 58 (m)	RG 213 (m)	CLA setting (dB)	RG 58 (m)	RG 213 (m)	CLA setting (dB)	RG 58 (m)	RG 213 (m)	CLA setting (dB)
53-57	111-121	0	38-43	79-89	0	8-13	16-26	0	41-46	87-97	0	
48-53	100-111	2	33-38	68-79	2	3-8	5-16	2	36-41	76-87	2	
43-48	89-100	4	28-33	58-68	4	0-3		4	31-36	66-76	4	
38-43	79-89	6	23-28	47-58	6				26-31	55-66	6	
33-38	68-79	8	18-23	37-47	8				21-26	45-55	8	
28-33	58-68	10	13-18	26-37	10				16-21	24-45	10	
23-28	47-58	12	8-13	16-26	12				11-16	24-34	12	
18-23	37-47	14	3-8	5-16	14				6-11	13-24	14	

Antenna cables

The amount of signal attenuation across a cable depends on the RF transmission frequency and the quality of the cable.

Note: Belden cable offers some medium-gage wideband cable types with extremely low attenuation values up to 3.2 dB for 100 feet (30 m) at 700 MHz.

Cable type	Impedance	Attenuation for 100 feet (30 m) at 700 MHz	Attenuation for 100 feet (30 m) at 200 MHz	Gage
RG-58C/U	50 Ohm	17.0 dB	7.3 dB	Small
RG-58/U	50 Ohm	11.7 dB	5.6 dB	Small
RG-59/U	75 Ohm	8.9 dB	4.5 dB	Small
RG-8/U	50 Ohm	3.6 dB	1.8 dB	Large

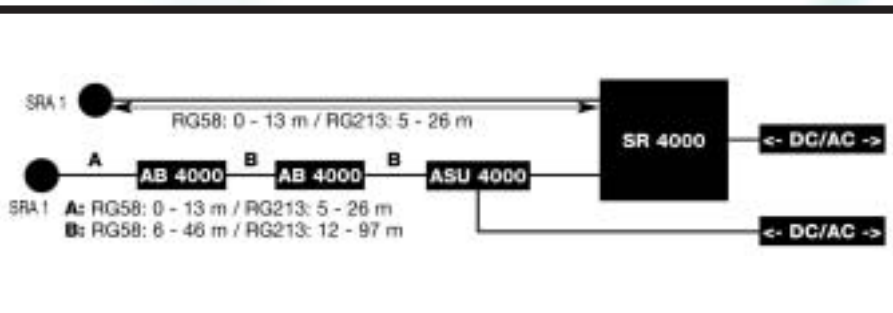

Single-channel system with SRA 1 passive antennas

For a single-channel system, you can connect the antennas directly to the receiver.

1. Measure the cable runs between the receiver and each antenna.
2. Refer to the table to find out whether you will need to break the cable run down into several cables and use antenna boosters.
3. Connect the antennas to the receiver. If you use antenna boosters, you will need a remote power adapter for each booster.
4. Check that the AC mains voltage stated on each power supply is identical to the AC mains voltage available at the venue. Using power supplies for a different AC voltage may cause damage to the unit.

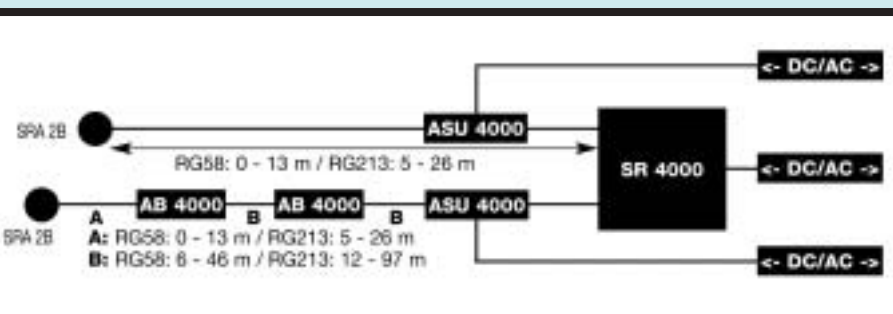

Single-channel system with active antennas

1. Measure the cable runs between the receiver and each active antenna.

2. Refer to the table below to find out whether you will need to break the cable run down into several cables and use antenna boosters.
3. Connect the antennas, antenna boosters, remote power adapter(s), and the receiver as shown in the diagram.
4. Check that the AC mains voltage stated on each power supply is identical to the AC mains voltage available at the venue. Using power supplies for a different AC voltage may cause damage to the unit.

Antenna cable

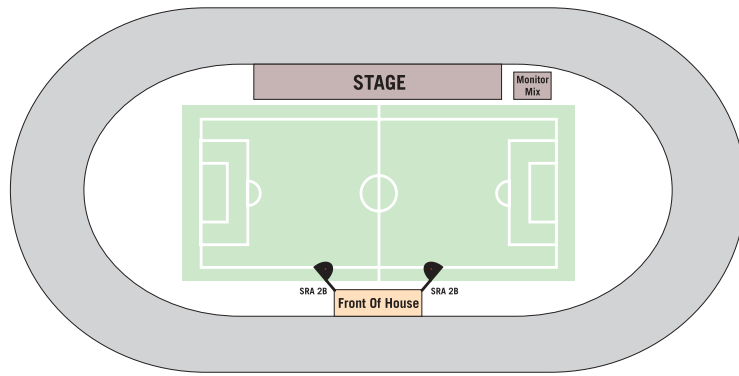

Stadium (theater, opera house) example 1:

Active directional antennas set up next to the receivers at the FOH mixing position.

Benefits:

- Consistent coverage of entire stage (no far-near problem)
- Short antenna cable runs

Drawbacks:

- This setup will not work unless the FOH mixing position is high enough above the audience.
- Risk of interference from local TV stations

The best antenna system for enclosed spaces.

Stadium example 2:

Active directional antennas set up far from the stage, with their reflectors oriented to blank out interference sources. The antennas were positioned on a straight line from the interference source (e.g., a local TV transmitter) to the receiving antennas and stage center, several meters above the audience.

Benefits:

- Consistent coverage of entire stage
- Dominant interference source is drowned out

Drawbacks:

- Risk of electrosmog interference
- Long cable runs (boosters may eliminate risk of intermodulation)

Excellent solution for enclosed spaces.

Antenna cable

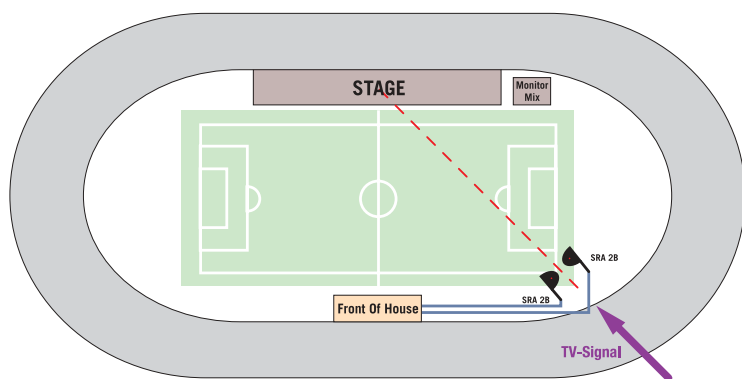

Stadium example 3:

Two passive directional antennas set up next to the receivers at the monitor mixing position.

Benefits:

- Wanted signal suppresses interference
- Simple wiring

Drawbacks:

- Unsuitable for large multichannel systems due to risk of intermodulation and shadowing (far-near problem)

Antenna cable

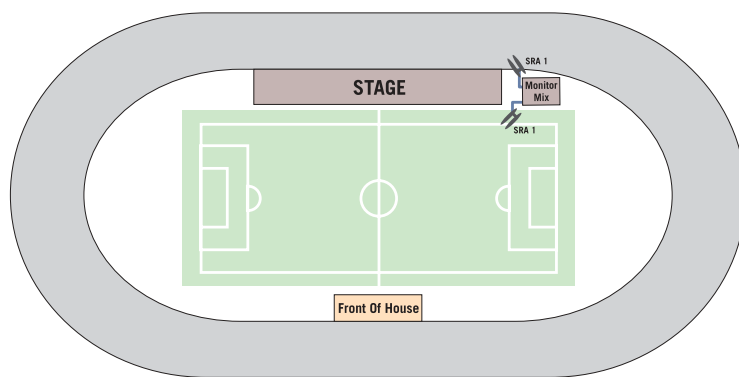

Stadium (theater, opera house) example 4:

Single passive directional antenna set up next to the receiver at the monitor mixing position, one active or passive omnidirectional antenna mounted at the opposite end of the stage.

Vorteile:

- Wanted signal is strong enough to suppress electrosmog.
- Far-near problem is smaller than in example 3.
- Simple wiring

Nachteile:

- Unsuitable for large multichannel systems
- The CLA settings for the two antenna channels must be carefully selected, otherwise the receivers may be fed the output signal of the same antenna all the time, effectively defeating the diversity function.

Antenna cable

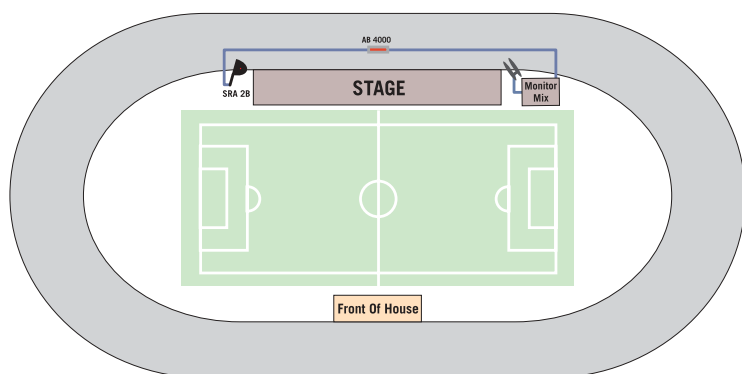

THE WMS 4000 MODULAR SYSTEM

MODULAR SOLUTIONS FOR PROFESSIONAL REQUIREMENTS

The WMS 4000 is probably the most innovative professional wireless system available today. It is based on intensive R&D and has been thoroughly tested under real-life conditions before being released for production. The objective of AKG's design engineers was extremely ambitious.

Therefore, all competitive systems were tested for ease of use and real-life reliability. Users were then asked to make a wish list of additional functions. These suggestions were examined for feasibility. The result is the new WMS 4000 wireless microphone system that had stirred up speculations and discussions within the audio community even before it was launched. The most striking detail of the new WMS 4000 Series is the advanced backlit display on both the handheld and bodypack transmitters and the receiver. The display makes it easy to check the selected preset and other important parameters including remaining battery

capacity in hours, gain setting, or intermodulation-free frequencies. The WMS 4000 transmitters provide a "Silent Mode" in which you can set all system parameters such as carrier frequency, gain, etc. without transmitting an RF signal. A "hidden" pilot tone in the 30 kHz range transmits battery status data to the receiver and allows automatic muting of the receiver audio outputs in case of signal loss.

The SR 4000 Stationary Receiver is a true diversity receiver that ensures exceptional reliability. A 30 MHz wide UHF subband allows many wireless microphones to be used simultaneously for smooth multichannel operation. An automatic frequency scanner and setup function quickly finds the best intermodulation-free frequencies from a bank of presets. The SR 4000 is highly frequency agile to accommodate any changes in frequency plans that may vary from date to date and location to location.

Unlike conventional wireless systems, the WMS 4000 components allow frequencies to be reprogrammed quickly and easily at any time.

The CU/BP 4000 charging system is a true innovation. The SBMS Smart Battery Management System includes a number of intelligent monitoring functions. Inflection Point and Peak Voltage Detect stops the charging in time, while an integrated temperature sensor in the battery pack protects the battery from overheating. A self-discharge counter ensures correct charging after the battery pack has been stored for a long time.

AKG uses advanced, future-oriented technologies for antennas as well. Several directional and omnidirectional antennas are available for every conceivable application, for small worship centers, theater productions, or large arenas.



Speech



Vocals



Guitar/Bass



Instruments



Installed sound



Live sound



TV studio



Theater



Worship center



HT 4000

- Wideband UHF handheld transmitter with interchangeable microphone elements and metal die-cast body
- Preprogrammed factory presets
- Up to 24 intermodulation-free frequency groups in each 30 MHz wide UHF band
- Over 15 hours continuous operation on 2 AA size alkaline batteries or a minimum of 12 hours on optional BP 4000 battery pack



PT 4000

- UHF bodypack transmitter with magnesium body
- 1200 selectable frequencies in 30 MHz band
- Backlit display and jog switch operation
- Up to 30 mW RF output for reliable transmission
- Optional remote mute switch
- Operates for up to 15 hours on AA batteries, 12 hours on optional BP 4000 battery pack, and displays remaining battery life



SR 4000

- True diversity UHF wideband receiver with 1200 selectable channels and all-metal case
- Preprogrammed factory presets
- Backlit LCD color display for checking operating parameters at a glance
- Setup control for quick and secure parameter setup
- SAuto Setup, Environment Scan, and Rehearsal functions for quick and easy frequency setting

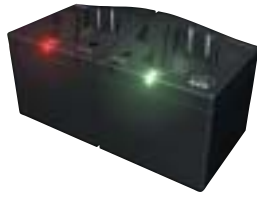

CU 4000/BP 4000

- Intelligent battery supply system comprising a CU 4000 charging unit and BP 4000 battery pack
- Microprocessor controlled charge/discharge monitoring function
- One-hour quick charging and Battery Recovery Management
- Charging compartment allows battery pack to be charged inside the transmitter



PS 4000

- Expandable modular antenna splitter with metal case
- 220 MHz bandwidth for use with all WMS 4000 channels
- Adjustable cable length compensation
- For multi-room installation of antenna systems



HUB 4000 Network concentrator

- For connecting up to 8 SR 4000 receivers to an Ethernet network



SRA 1 – Passive wideband directional antenna

- For indoor and outdoor use, specifically for setting up long-range radio links
- For use with short antenna cables up to 5 m (16 ft) long

AB 4000 – Antenna booster

- Ultralinear antenna booster with water-resistant case
 - BNC or N inputs and outputs, DC input, status LED



SRA 2B – Active wideband directional antenna

- For indoor and outdoor use, in particular for setting up radio links for distances up to 300 m (1000 ft)
- Integrated high-performance antenna booster for use with antenna cables up to 200 m (655 ft) long (RG 213, in conjunction with 2 x AB 4000)
- Remote powering option, status LED
- Rugged water-resistant case with BNC output
- Optional laser positioning pointer



RA 4000 B

– Omnidirectional wideband booster antenna

- For indoor and outdoor use, in particular for near-field antenna setups with no preferred direction
- Integrated high-performance antenna booster for use with antenna cables up to 180 m (600 ft) long (RG 213, in conjunction with 2 x AB 4000)
- Remote powering option, status LED
- Rugged water-resistant case with BNC output



ASU 4000 – Remote power supply for antennas

- BNC or N inputs/outputs
- Locking DC input
- Status LED
- Water-resistant case



HPA 4000 Headphone amplifier

- For connecting up to 8 SR 4000 receivers

PSU 4000 Central power supply unit

- Powers up to 12 SR 4000 receivers plus antennas via 3 PS 4000 antenna splitters, or three CU 4000 charging units
 - Also powers the HPA 4000 headphone amplifier or HUB 4000 network concentrator



AKG WMS 4000 TRANSMITTERS

HANDHELD AND BODYPACK TRANSMITTERS FOR LIMITLESS OPTIONS

The WMS 4000 handheld and bodypack transmitters are two truly universal products that will meet the toughest requirements. Both the HT 4000 and PT 4000 have a 30 MHz wide UHF band and up to 1200 selectable frequencies, with an RF output of up to 50 mW that ensures maximum transmission security even in difficult environments. All functions are controlled via an easy-to-use jog switch. The backlit display provides information on all important data, such as remaining battery life, carrier frequency, input

gain, programmable channel name etc. The smart electronic circuitry, combined with the BP 4000 battery pack, ensures an accurate readout of the battery status, while all status data are continuously updated via pilot tone between transmitter and receiver.

The HT 4000 handheld transmitter is equipped with interchangeable microphone elements, thus offering a wide choice of sounds and polar patterns to suit different applications. An electronically lockable on/off key

and an easily accessible mute switch ensure additional convenience.

Thanks to its extremely rugged yet light-weight magnesium body, the PT 4000 bodypack transmitter is suited for any kind of usage on stage. The Mini XLR connector accepts a wide range of microphones and instruments. An additional jack for connecting a remote mute switch allows easy muting even if the transmitter is concealed in the clothes.

Interchangeable microphone elements

100% AKG Acoustics: Tec Award winning C 900^M, Emotion D 880^M, TRIPOWER D 3700^M, D 3800^M, C 5900^M, C 535.

HT 4000 Handheld transmitter

LED status display

Indicates the most important operating parameters at a glance.

Backlit display

Ensures easy setup and accurate status monitoring even on a dark stage.

Soft-touch finish

Helps reduce handling noise.

Battery compartment

Jog switch

Easy menu control; no need to use any tools.

Charging and programming contacts

For an easy recharging of the BP 4000 battery pack inside the transmitter.

Electronically lockable on/off key and protruding mute switch

Easily distinguishable and protected against unintentional actuation.

On/off key, Mute switch, Jog switch and charging contacts



	Battery status readout Displays the remaining battery life in hours.
	Frequency presets Sets of intermodulation-free frequencies make setting up a multichannel system easy.
	Automatic gain setting Manual and automatic gain setting.

	7
	6
	4 5

Display details

- 1 Lock indicator
- 2 Battery status
- 3 Frequency setup menu
- 4 Input gain menu
- 5 Input level bargraph with peak hold indicator
- 6 Mute indicator
- 7 Frequency/preset display



Rugged professional 3-pin mini XLR connector
Connects all AKG microphones, such as the MicroMic series, CK 77 WR, Discreet Acoustics Modular lavalier module, etc.

PT 4000 Portable transmitter

Electronically lockable on/off key and protruding mute switch

LED status display

Backlit display

0.1" jack for remote MUTE switch
Easy muting even if bodypack transmitter is concealed.

Inscribable color code element

Charging and programming contacts

Magnesium body
Lightweight and extremely rugged.



“Silent Mode” setting

WMS 4000 transmitters feature a “silent mode” that allows you to set all system parameters, e.g., frequency, gain etc., without “going on air”. This allows you to set up a replacement transmitter behind the scenes without disrupting the performance.



The “hidden” pilot tone

HT 4000 and PT 4000 transmit a pilot tone (approx. 30 kHz) “hidden” inside the radio signal to the receiver. This allows the pilot tone detection circuit to determine whether there is a transmitter in the coverage area, and noiselessly activate or mute the audio output of the receiver (TCSQ Tone Code Squelch). In addition, important transmitter status information such as remaining battery life and the MUTE switch position can be shown on the receiver display.

AKG WMS 4000 RECEIVER

THE CUTTING-EDGE TRUE DIVERSITY RECEIVER

The SR 4000 True Diversity Receiver offers maximum convenience with state-of-the-art technology and the widest range of functions in its class.

Naturally, the SR 4000 is optimally equipped for the setup of large multichannel systems, so that connecting antenna splitters, power supply units, computer networks, etc. is quite easy.

The accurate battery life readout is a novel and invaluable feature for live sound applications. The transmitter uses a pilot tone to transmit accurate information such as bat-

tery status to the receiver that displays the remaining battery life in hours. The pilot tone decoder also evaluates and displays other important data including the status of the MUTE switch on the transmitter.

The integrated software does not only permit automatic setup and frequency scanning but also remote control and monitoring from a PC via a dedicated interface. With the optional MCS 4000 Mission Control Software, setting up and monitoring highly complex systems is child's play. A logic output allows control of external devices, e.g., automatic microphone mixers.

Of course the SR 4000 operates in an extremely wide UHF band (30 MHz) with preprogrammed frequency presets, each providing up to 24 intermodulation-free subchannels*. The maximum number of selectable frequencies is 1200. The large backlit color display and the setup control make the unit easy to use, and a programmable LED ring indicates selectable critical conditions.

Housed in a half-rack 19" all-metal case, the SR 4000 is the most compact, reliable, and powerful UHF receiver in its class.

Backlit display

High-contrast color display using "Black Mask" technology indicates all system parameters in plain text.

Half-rack 19" all-metal case

Standard accessories include a rugged rack-mounting kit.



SR 4000 Receiver

Jog switch

For simple programming of the receiver

Programmable status display

Displays for LowBatt, Audio Level, RF Level and Diversity at a glance



JOG SWITCH

Multifunctional control element for system programming, no tool needed, can be operated single-handed.

<p>Display details</p> <ul style="list-style-type: none"> ❶ 8-segment Audio Bargraph Display ❷ Frequency Setup Menu, 3 modes: Auto, Preset, Frequency ❸ Scanning function: AutoScan detects RF signal in the entire bandwidth ❹ Setup for SQL, Level, or TCSQ 		<p>Display details</p> <ul style="list-style-type: none"> ❺ Rehearsal Mode: Quick check of RF and AF signal quality ❻ Special functions: Receiver name, status display, threshold level, system info, ... ❼ 8-segment RF Bargraph Display incl. diversity
----------------------------------------------------------------------------------------------------------------------------------------------------------------------------------------------------------------------------------------------------------------------------------------------------------------	--	---------------------------------------------------------------------------------------------------------------------------------------------------------------------------------------------------------------------------------------------------------------------------------------------------

* The maximum number of selectable channels may vary in accordance with local frequency plans.

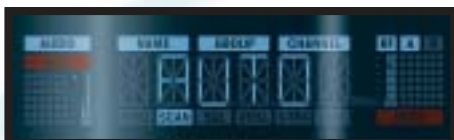

Auto Setup
Automatic frequency setting and finding of free channels.

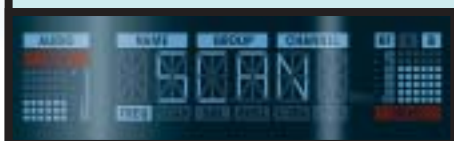

Environment Scan
Analyzes the RF environment for interference-free transmission.



Rehearsal Mode
Setup Assistant for the optimal setting of the system parameters.



Battery life display
Display of transmitter's remaining battery life in hours.

Environment Scan and Rehearsal Mode
The SR 4000 comes with a large number of assistants that make a professional setup incredibly easy and substantially increase operating reliability. The Environment Scan “spies on” the RF environment and warns of interfering frequencies in time (e.g., active TV transmitters etc.).

Rehearsal Mode also features an early warning system that records the most important system parameters during the soundcheck and can be used to identify potential problems ahead of time.

Multichannel capability, frequency management, and auto setup

Its wide frequency range and multiplicity of selectable frequencies make the WMS 4000 an excellent choice for multichannel systems. The built-in frequency management system helps you find the right frequency. Preset banks provide sets of intermodulation-free frequencies. The Auto Setup function rapidly identifies clean frequencies. For a FREE download of the frequency management program for your PC, visit www.akg.com/frequencies.

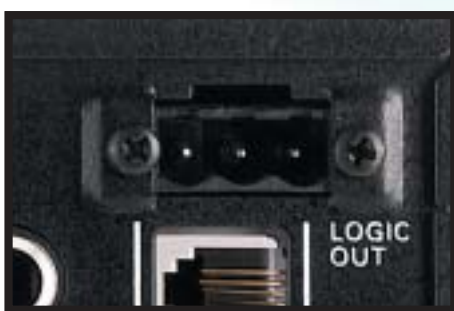
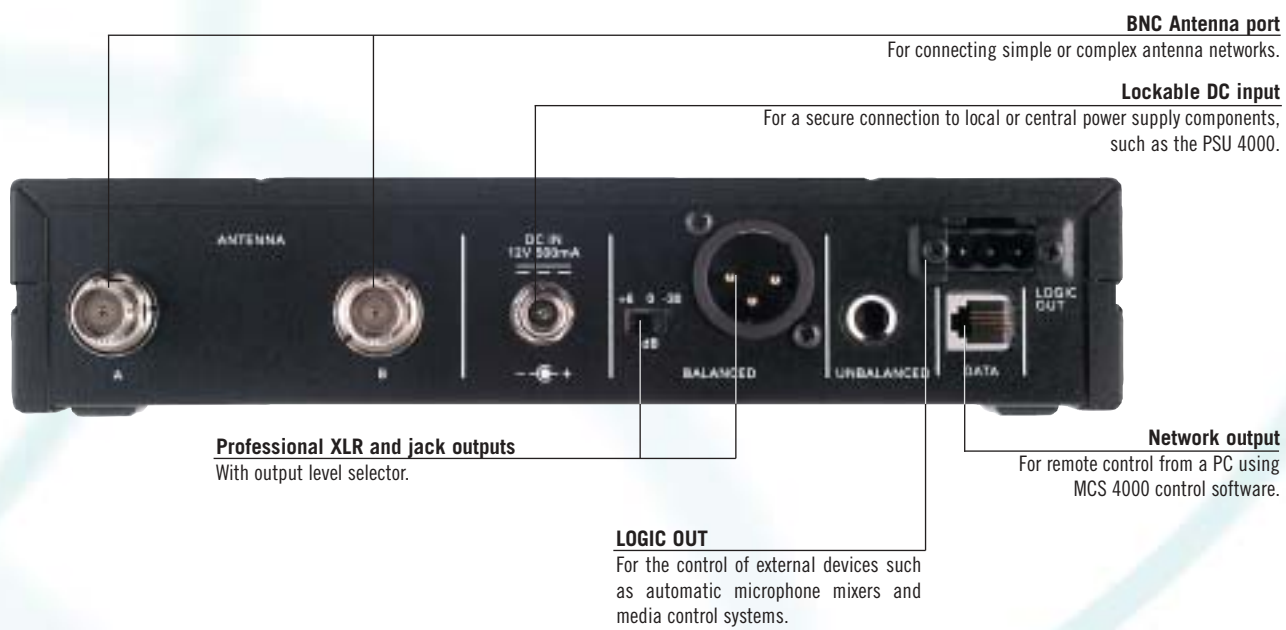

Logic Out and Output Level Selector
The Logic Out supplies the following information: first, a signal indicating the mute status of the audio output, and second, the condition of the transmitter batteries. A unit with Logic In can be programmed to have a signal light illuminating when the transmitter battery is low. The output level selector can be used for setting the audio signal either to standard level or to +6 or -30 dB. This function allows you, for example, to adjust the level of a wireless condenser microphone to that of a hardwire dynamic microphone.



AKG WMS 4000 CHARGING SYSTEM

THE INTELLIGENT WAY TO POWER WMS 4000 TRANSMITTERS

The CU 4000 Charging Unit revolutionizes battery management for wireless systems. The heart of the charging system is the BP 4000 Battery Pack with built-in active monitoring. An integrated microprocessor continuously monitors battery status and accurately calculates the remaining battery life. In conjunction with a WMS 4000 wireless transmitter, these data are not only indicated on the transmitter display but are also transmitted to the receiver via pilot tone. The transmitter's remaining battery life can thus be read out on the receiver within a few minutes' accuracy, putting an end to the nightmare of batteries failing in the middle of a performance.

A processor-controlled pulse charging system charges the battery pack quickly yet gently, while the integrated "Charge Balance Management" feature makes sure that only as much energy is fed to the battery pack as had previously been drawn from it. In addition, several monitoring circuits and a temperature sensor prevent the battery pack from being overcharged.

A self-discharge counter does not only measure battery discharge during operation but also determines the amount of discharge after prolonged storage periods. As charging begins, the BP 4000 circuitry communicates with the

CU 4000 charging unit in order to "tailor" the charging process optimally to the status of the battery pack. To eliminate memory effect, the CU 4000 automatically checks whether the batteries need a recovery cycle, and automatically starts the cycle upon confirmation by the user. The charging unit provides two charging compartments that allow you to charge two transmitters (HT 4000, PT 4000) or two battery packs at the same time.

The combined BP 4000 plus CU 4000 system is an investment that will quickly help cut expenses and reduce environmental hazards from used batteries.

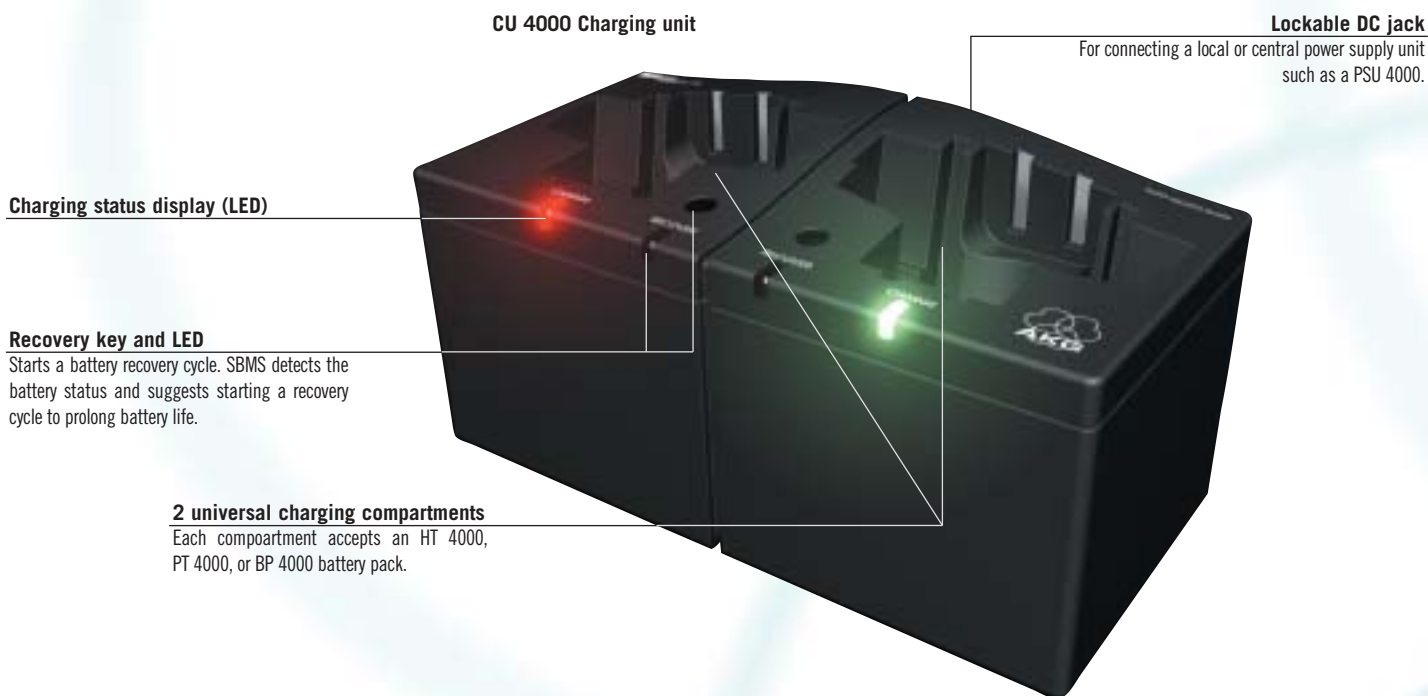

BATTERY CARE

Rechargeable batteries are known to suffer from the so-called "memory effect". The capacity of a rechargeable battery will decrease over time if it is not fully discharged. If a battery is discharged only to 50% of its capacity over many charging cycles, it will finally "believe" its capacity to be only 50%, so that it cannot be charged fully any more. To eliminate memory effect, we recommend completely discharging and recharging the battery pack periodically (recovery cycle). SBMS permanently monitors battery parameters and detects the need for a recovery cycle.

The Recover LED illuminates to indicate it is time for servicing the battery pack. Since a recovery cycle may take 14 hours, the best time to run it is during the night. In any case you will need to start the recovery cycle manually. If you service your battery pack regularly it will retain its maximum capacity throughout its useful life.

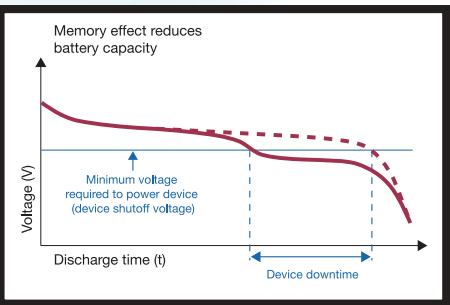

MOBILE CHARGING UNITS

CU 4000 – Charging unit in a flight case

Several charging units can be fitted into a rugged flight case as a compact solution for large systems.



BP 4000 Intelligent quick-replacement battery pack

Internal RAM

Records charging/discharging processes and provides a database for optimizing charging parameters (Charge Balance Management).

Data interface to transmitter electronics

Sends battery status information to the transmitter for accurate capacity readout.



Integrated temperature sensor

Protects the battery pack against overcharging and damage.

Ladestation Features:

- Smart battery management – overcharging protection
- 2-slot power management
- 1 hour quick charge
- Recovery Mode for complete recovery of old or damaged batteries
- Integrated “database” for optimum charging management
- Integrated temperature sensor
- Self-discharge counter
- Integrated RAM

Smart Battery Management System (SBMS)

An environmentally friendly money saver, the SBMS Smart Battery Management System is the heart of a completely new charging technology. It monitors battery status and controls the charging process. The battery status is read out in remaining hours of battery life on the transmitter and receiver displays, so you can recharge the battery pack in time. The SBMS includes a number of intelligent monitoring functions.

“Inflection Point and Peak Voltage Detect” stops the charging in time, while an integrated temperature sensor in the battery pack protects it from overheating. The Charge Balance Management feature makes sure that only as much energy is fed to the battery pack as had previously been drawn from it. A self-discharge counter ensures correct charging after the battery pack has been stored for a long time. The battery pack uses an integrated database and charger interface to set its own charging current.



AKG WMS 4000 ANTENNA SPLITTER

THE INDESPENSABLE COMPONENT FOR LARGE WIRELESS SYSTEMS

One or several PS 4000 antenna splitters can be used to set up complex systems with long antenna cables, distributed antenna networks for room sharing applications, or to feed the signal from a single antenna pair to several receivers.

The 220 MHz bandwidth guarantees the full coverage of all channels available in the WMS 4000 system. The processing and amplification of true diversity signals in combination

with various optionally available antennas ensure maximum reliability of reception.

Highly visible LED displays provide a clear status indication even from a distance. A gain selector switch allows for optimum matching to connected antenna cable lengths to ensure optimum signal quality.

The PS 4000 antenna splitter features 2 BNC antenna inputs and 4 diversity outputs on

8 BNC sockets as well as two additional BNC sockets for daisy chaining several antenna splitters. This allows you to implement complex systems with 50 or more receivers.

Of course the PS 4000 can be powered centrally via a PSU 4000 Power Supply Unit so that it can also work as a remote powering unit for active antennas. The required voltage is supplied via the antenna cables, eliminating the need for separate antenna power cables.



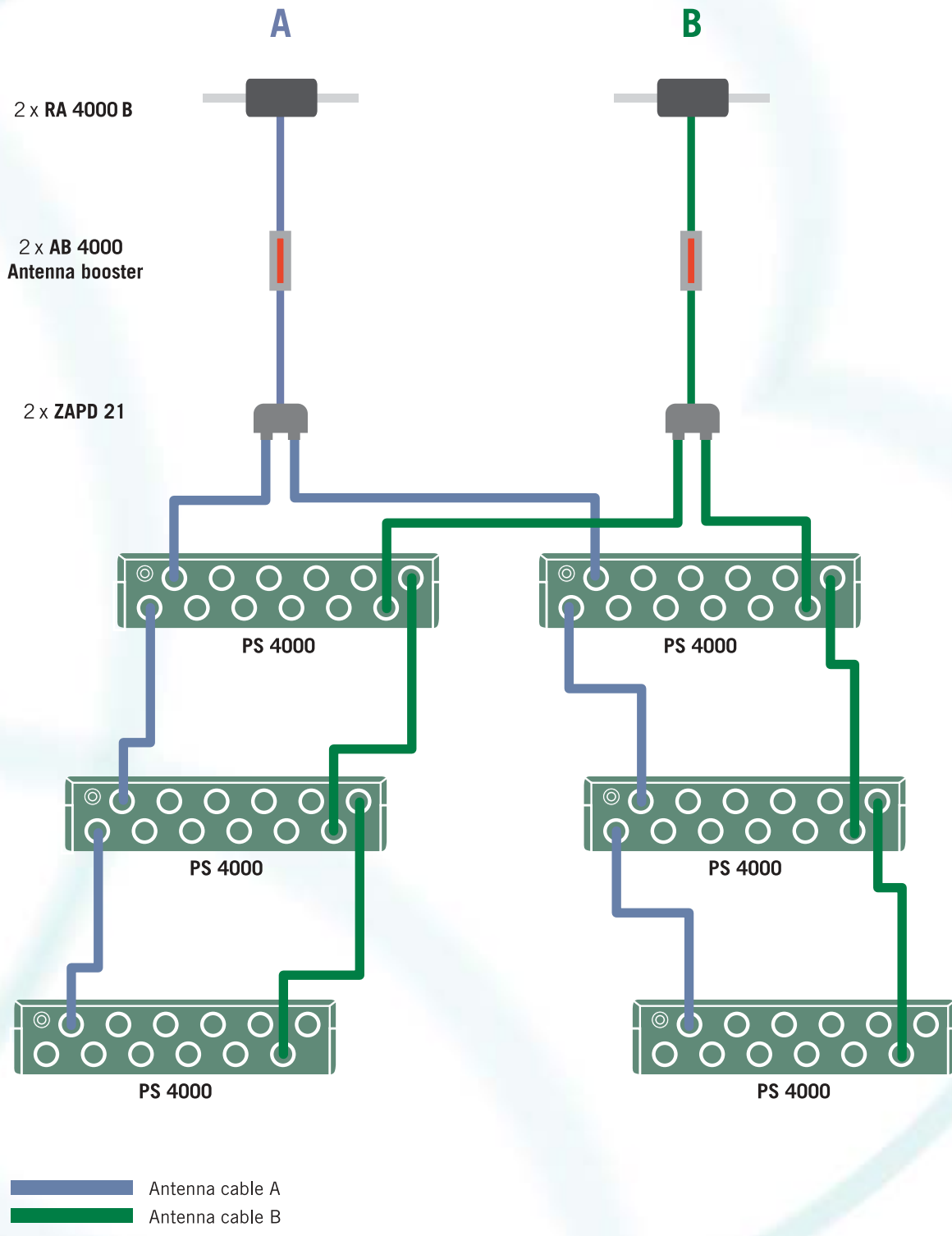

Selecting antenna cables

Antenna cables are needed for feeding the signal of a remote antenna to the receiver. However, all antenna cables attenuate the antenna signal (cable attenuation). Since different types of cables have different attenuation values, each type will perform best at a different length. While low-attenuation cables are usually thicker and more expensive, they can be used for much longer runs. You can compensate for long cable runs by using antenna boosters or active antennas. In some cases, however, using the next higher (if slightly more expensive) grade of cable may do the trick, eliminating the need to use active antenna components. The right type of cable can

be essential to the performance of your wireless system, prevent problems, and help reduce costs.

A bank of dip switches on the boosters and the PS 4000 antenna splitter allows you to match the RF signal level to the antenna input depending on the frequency band, antenna type, cable type, and cable length.



AKG WMS 4000 ANTENNAS/ACCESSORIES

ANTENNAS TAILORED TO EVERY SITUATION

With its antennas and optional accessories specially “tailored” to the WMS 4000 System, AKG offers the optimum solution to any type of application, allowing users to implement even the most complex antenna networks easily and efficiently.

With its omnidirectional polar pattern, the RA 4000 B Booster Antenna is a good choice for most applications. Thanks to its rugged, water-resistant case and the integrated antenna booster for use with antenna cables up to 180 m (600 feet) long, the RA 4000 B is even suited for outdoor applications.

The SRA 1 directional antenna is especially suitable for setting up long-range radio links if short antenna cables are used. Because of the passive operation and the 70° beam angle in combination with good off-axis attenuation and front-to-rear ratio, it works particularly well in interference-prone RF environments.

The SRA 2 B is an active directional antenna that works with long-range radio links (up to 300 m / 1000 feet) and long antenna distances. An optional laser positioning pointer makes it easy to aim the antenna precisely at its target area.

The AB 4000 is a highly efficient antenna booster for inserting into long antenna cables. One booster can compensate for approx. 17 dB cable attenuation, allowing cable runs to be extended by approx. 60 m (200 feet). Up to 2 antenna boosters can be used in series for extremely long cable runs.

The ASU 4000 is a remote power adapter for creating additional power feeds to complex antenna networks. Thanks to its small dimensions, it is even possible to integrate the ASU 4000 into narrow antenna cable ducts at a later date.

Cabling example/cable lengths:

Maximum cable lengths:

90 m / 300 ft. (@Band VI) to 125 m / 410 ft. (@Band I) of RG 58 180 m / 600 ft. (@Band VI) to 250 m / 820 ft. (@Band I) of RG 213

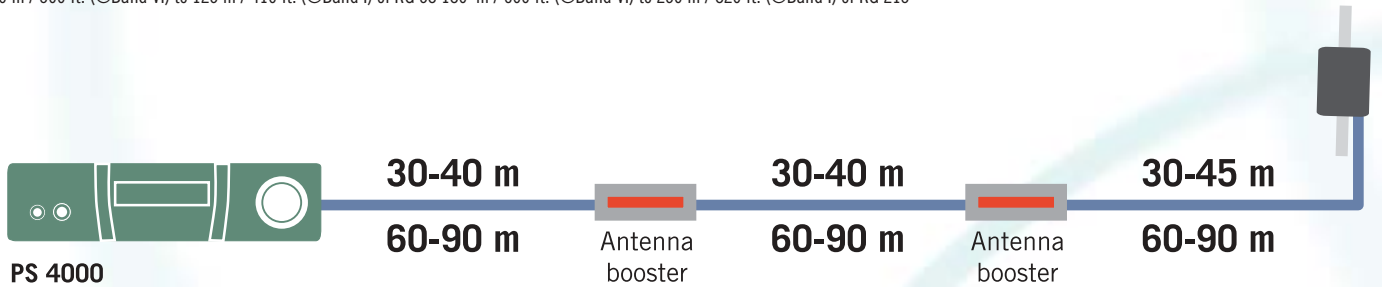

Installed sound

Live sound



Selecting and placing antennas

The antenna is the “ear” of the radio system, which is why antennas must be selected and placed carefully. Antennas have polar patterns similar to those of microphones, and depending on the application, you may need Yagi antennas (comparable to cardioid/hypercardioid microphones), Log Periodic (like shotgun microphones), or omnidirectional antennas.

If the transmitters will be used only within a rather small area such as a stage, use directional antennas. Directional antennas are generally used to overcome long distances or suppress unwanted signals from other directions, e.g., at open-air locations. Omnidirectional antennas are ideal for near-field applications where no external-direction interference is expected, e.g., indoor events (most directional antennas are big and difficult to conceal) or multipurpose halls with no preferred direction.



TV studio



Theater

Worship center

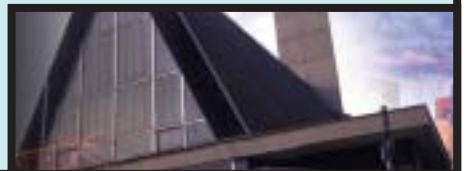



SRA 1 – Passive wideband directional antenna

- For indoor and outdoor use, in particular for setting up long-range radio links
- For use with short antenna cables up to 5 m (16 feet) long
- Water-resistant design with BNC output

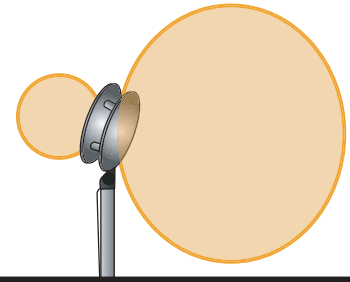

SRA 2B – Active wideband directional antenna

- For indoor and outdoor use, in particular for setting up radio links for distances up to 300 m (1000 feet)
- Integrated high-performance antenna booster for use with antenna cables up to 100 m (330 feet) (RG 58) or 200 m (655 feet) long (RG 213), in conjunction with 2 AB 4000s
- Remote powering option
- Rugged, water-resistant case with BNC output
- Status LED
- Optional laser positioning pointer

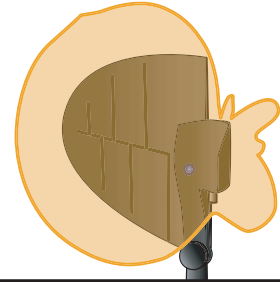

RA 4000 B – Omnidirectional wideband booster antenna

- For indoor and outdoor use, in particular for near-field antenna setups with no preferred direction
- Integrated high-performance antenna booster for use with antenna cables up to 90 m (300 feet) long (RG 58) or 180 m (600 feet) long (RG 213), in conjunction with 2 AB 4000s
- Remote powering option
- Rugged, water-resistant case with BNC output
- Status LED

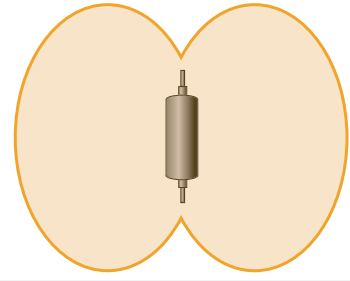

AB 4000 – Antenna booster

- BNC or N connector inputs/outputs
- DC input
- Status LED
- Water-resistant case



ASU 4000 – Remote power adapter for antennas

- BNC or N connector inputs/outputs
- Lockable DC input
- Status LED
- Water-resistant case



ZAPD-21 Antenna combiner

- For indoor and outdoor use
- For setting up complex antenna networks
- Use as 2 in - 1 out antenna combiner for multiple-antenna systems
- Use a 1 in - 2 out antenna splitter for daisy-chaining several PS 4000s within large multichannel systems

AKG WMS 4000 NETWORK CONCENTRATOR

THE LINK BETWEEN THE WMS 4000 AND A PC NETWORK

The HUB 4000 is the intelligent hardware interface between a WMS 4000 wireless system and one (or several) PCs. No more need for cumbersome cabling; the HUB 4000 concentrates the data flow of up to eight receivers and connects easily to any PC with an Ethernet interface.

Naturally, complex systems can also use several HUB 4000s – in fact, up to 16. With eight receivers per hub, you can operate a maximum

of 128 receivers – from a single PC!

The HUB 4000 meets all standards and requirements for smooth operation with PC components. Connection to the PC or PC network is via standard CAT-5 Ethernet cables with RJ-45 connectors, while the data are transmitted via IP protocol.

Working with WMS 4000 multichannel systems, you can optimize operating convenience

and reliability by simply linking the WMS 4000 PC network components with standard PC accessories. This allows you to send receiver data through the HUB to a wireless LAN, and receive them on a tablet PC. In the REHEARSAL mode, you can take the PC on the stage and monitor important data such as RF levels on site. This makes it incredibly easy to set up the most complex system and ensures maximum operating reliability.

HUB 4000 Network concentrator



On/off switch

Status LED

Display indicating the active channel

Data connection

For a reliable data transfer to the PC and addressing the MCS 4000 "Mission Control Software".

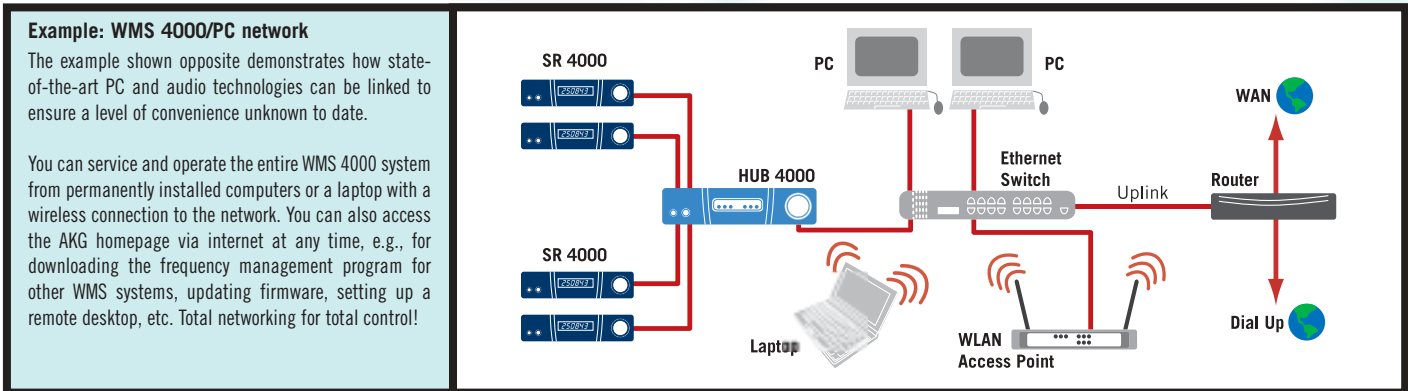

AKG WMS 4000 MISSION CONTROL SOFTWARE

YOUR COMPUTER AS A WMS 4000 CONTROL CENTER

The MCS 4000 Mission Control Software allows you to display the entire setup of a WMS system on screen and to edit all settings simply by mouse click.

All relevant data, such as RF level, audio level, diversity activity, battery status of the transmitters, Mute/Off etc. are displayed in real time on a graphic user surface, with important warning messages being inserted so as to catch the eye.

You can even set up the basic parameters of

a complete system from the computer: remote control software puts Environment Scan, Auto Setup and Rehearsal Check at your fingertips.

“History” recording is another special feature of MCS 4000 – i.e., storing the monitoring data of all channels in a log file to help with the setup and the analysis of completed system.

You can also take a snapshot of the current status any time, which is especially helpful if

you want to mail it to off-site co-workers.

Linking a wireless system to the computer only requires the integration of one or several WMS 4000 HUB Network Concentrators plus a computer (>500 MHz) with an Ethernet port.

MCS 4000 is available for Windows, Mac OS X, and Linux. A demo version as well as software and firmware updates and drivers can be downloaded from www.akg.com.

Programm and monitor connected receivers

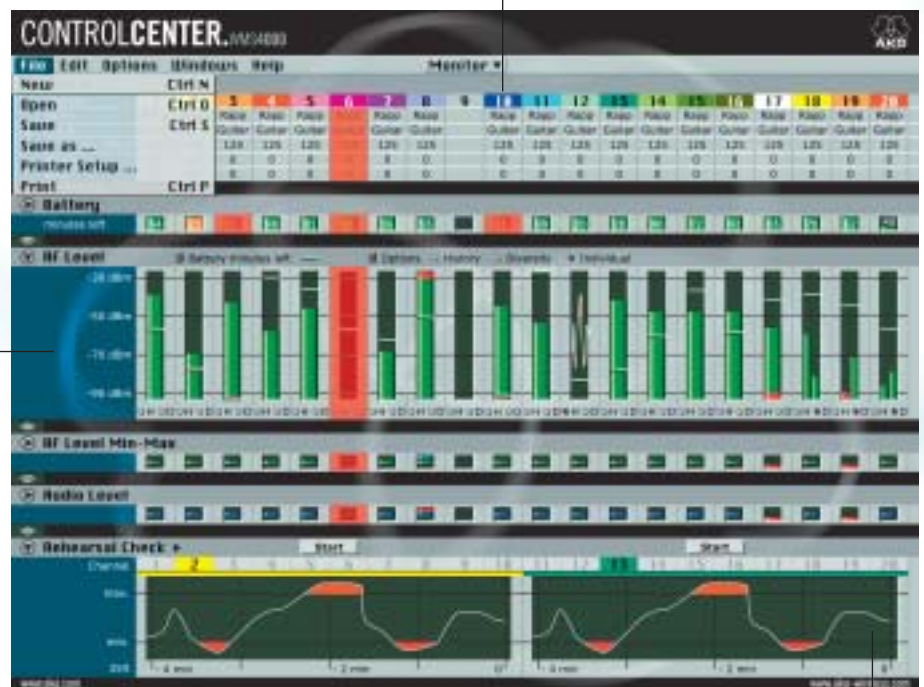

RF and audio level display

Graphic Scanner and Enhanced AutoSetup Mode

“Get a Cup” Setup Mode

Finding and setting the right frequencies for a multichannel setup is a difficult and time-consuming job. The WMS 4000 provides several functions including Auto Setup and Environment Scan to speed up the process. The MCS 4000 is an incredibly convenient software tool. It scans the system's RF environment and uses an integrated frequency management database to calculate optimum frequencies. It automatically programs these frequencies into the receivers via the HUB 4000 to complete the setup while you have a cup of coffee.



“Moving PC” Rehearsal Mode

When working with WMS 4000 multichannel systems, you can optimize operating convenience and reliability by simply linking the WMS 4000 PC network components with standard PC accessories. This allows you to send receiver data through the HUB to a wireless LAN, and receive them on a tablet PC. In the REHEARSAL mode, you can take the PC on the stage and monitor important data such as RF levels on site. This makes it incredibly easy to set up the most complex system and ensures maximum operating reliability.

AKG WMS 4000 POWER SUPPLY

RELIABLE POWER SUPPLY FOR THE COMPLETE WMS 4000 SYSTEM

The PSU 4000 is a central power supply unit for all components of the WMS 4000 system. A stable, interference-free voltage (15 V/2 A or 15 V/2.5 A respectively) at three outputs ensures a stable network. Valuable power strip outlets are thus kept free, and

hum from poorly grounded power cables can be minimized.

The PSU 4000 is an essential tool especially for mobile racks, since it saves a lot of time during installation and takedown. The

clearly visible display indicates the current power supply status. The low-noise fan ensures optimum cooling of the power supply unit, even at high ambient temperatures and under full load.

PSU 4000 Central power supply unit

1 AC input, 3 DC outputs (15 V, 2 A), lockable

On/off switch

Power indicator

Status display



100 – 240 V AC input



3 DC outputs

Tailor-made DC outputs

If each of the three DC outputs is connected to a PS 4000 antenna splitter, the antenna splitter to which the antennas are ultimately connected must be connected to DC OUT 1. This is because due to cable attenuation, the antenna system will draw 2.5 A, which is only available from DC OUT 1 (outputs #2 and #3 supply 2 A each).

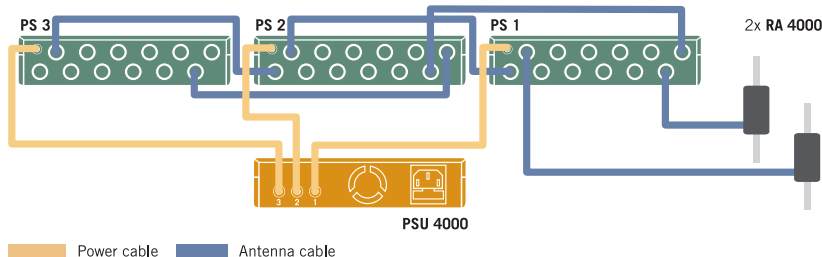

AKG WMS 4000 HEADPHONE AMPLIFIER

MONITORING WITHOUT A MIXER

Integrating an HPA headphone amplifier into the WMS 4000 system makes life a lot easier for the FOH engineer. During the performance, the audio output signals of each receiver can be monitored directly, without having to

bother with an extra mixer. This feature proves an invaluable advantage, particularly if the WMS 4000 system and the mixer are located in different rooms, with the audio connection as a potential error source.

The HPA 4000 comes with eight jack inputs and one jack output for headphones. Channels can be routed to the headphone output using a rotary control. A clearly visible display indicates the currently active channel.

HPA 4000 Headphone amplifier



Recommended headphones

For the monitoring of live performances, AKG recommends closed-back headphones in order to ensure maximum attenuation of ambient noise.

The best choices are the K 171 Studio and the K 271 Studio.



K 171 Studio



K 271 Studio

WMS 4000 8-CHANNEL SETUP

EXAMPLE: 8-CHANNEL SYSTEM FOR VARIABLE ARRANGEMENTS OF SEMINAR ROOMS

Wireless systems are becoming increasingly popular for conference centers and seminar hotels. Unlike open-air events and large-scale performance facilities, the main focus here is not on coverage or the optimal utilization of as many channels as possible, but maximum flexibility.

Several events taking place at the same time, adaptable sizes of seminar rooms, and a high level of reliability, combined with maximum mobility of lecturers – these are the essential parameters that need to be considered when planning wireless systems for seminar centers.

The example of a typical seminar hotel can demonstrate the large variety of options available to organizers with a well-designed 8-channel system.

Optimum room coverage via high-performance antennas and diversity reception for preventing dead spots are the key prerequisites. Anything from one to eight channels must be available for three structurally separated rooms, one of which can be divided by a variable partition. Optimum RF coverage of each room is ensured by one pair of booster antennas per room and two pairs in the variable room.

This arrangement maintains full diversity functionality even if the room is partitioned. The various antenna cables from the seminar rooms are joined together by antenna combiners and the signals distributed to the receivers via antenna splitters. Where longer cable runs are needed, additional antenna boosters are integrated into the line.









To save space, the wireless system can be mounted in a rack or placed in a separate equipment room. This unobtrusive installation will not impair the effect of the interior decoration.

Seminars

At seminars and lectures held in relatively small rooms, care must be taken to identify possible dead spots that can occur despite the short distances. Furniture, people, lots of electronic devices (luminescent tubes!), curtains, blinds etc. can cause wireless systems to fail even in confined spaces. We recommend using a true diversity system in conjunction with high-performance antennas.



Specification:

	Amount	Item	Description
	8 x	SR 4000	True diversity receiver
	4 x	CU 4000	Charging unit
	8 x	HT/PT 4000	Handheld or portable transmitter
	2 x	PS 4000	Antenna splitter
	2 x	PSU 4000	Central power supply unit
	6 x	ZAPD 21	Antenna combiner
	8 x	RA 4000 B	Booster antenna
	4 x	AB 4000	Antenna booster

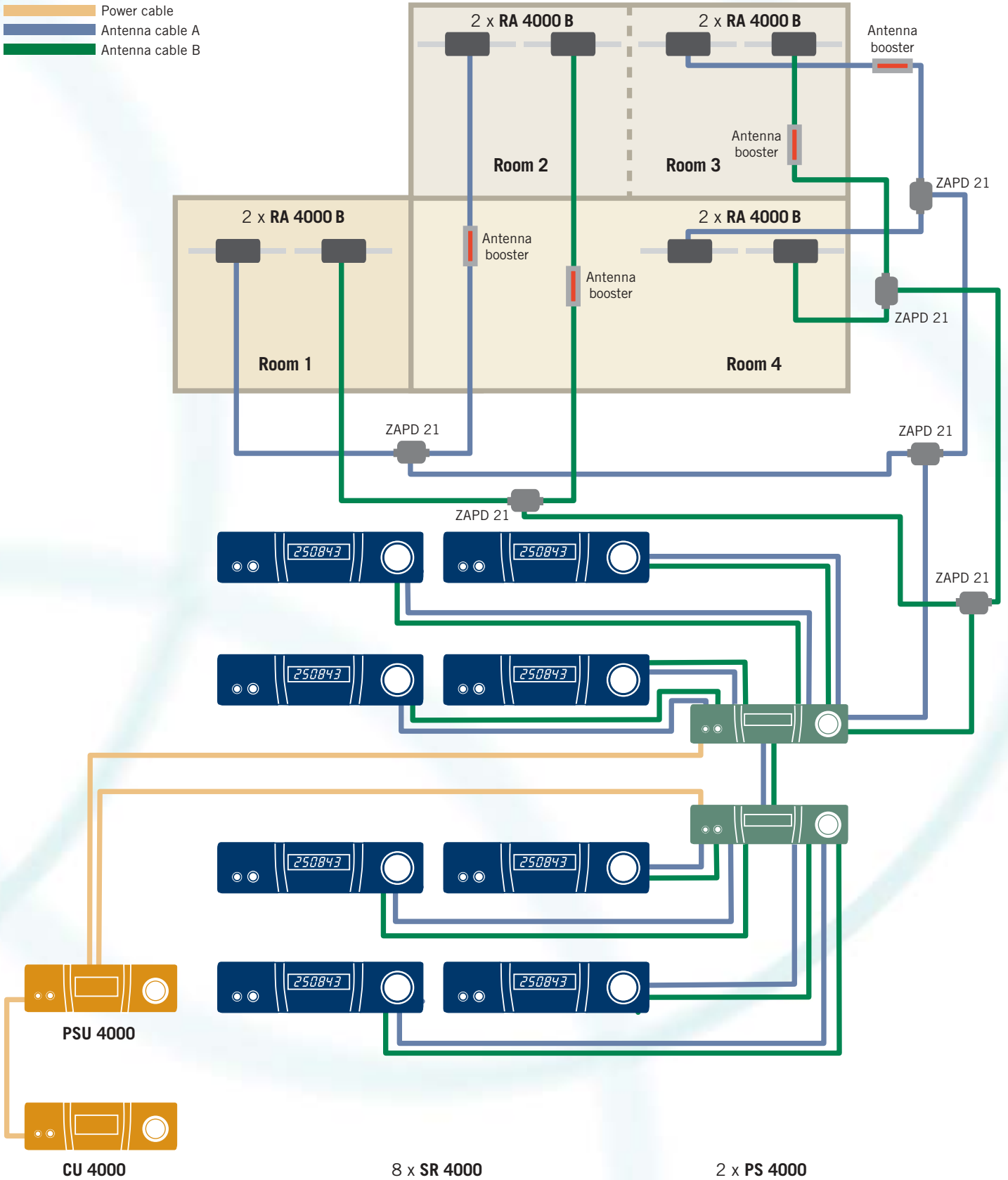

WMS 4000 10-CHANNEL SETUP

EXAMPLE: 10-CHANNEL SYSTEM FOR TOUR SOUND

Fitting all components into flight cases as well as the shortest possible setup time are essential for festivals with several acts performing in succession. While one performer is on stage, backstage preparations for the following act must be completed so that it can be started without any drawn-out interruptions due to alterations or soundchecks. Wireless systems in particular require meticulous performance tests to be carried out – both regarding RF and audio signals – before they are connected to the FOH mixer. The advanced software of the SR 4000 receiver makes all this easy. Rehearsal Mode, Auto Setup, and Frequency Scan are just a few

of the features that help set up all the RF connections quickly and efficiently.

However, the ultimate quality of the audio signal delivered by the receiver can only be tested by connecting the receiver to the mixer, which is practically impossible once the show has started.

Two HPA 4000 headphone amplifiers, each connected to five receivers, eliminate this problem, enabling you to check audio signal quality quickly and reliably without an additional mixer.

In the example shown above, a complete 10-channel wireless system including antenna splitters, power supply unit and headphone amplifiers can be fitted into a compact 8 U rack. You can also fit two small flight cases with five charging units each for the transmitters, so that all transmitters can be charged completely and simultaneously within just one hour.

And, the complete tour sound package takes up so little space that it can be transported in a standard station wagon – the ideal solution for touring bands.







Tour Sound

The WMS 4000 is specifically suited for small tour setups, since the large variety of selectable channels allows you to find a working setup for practically any application.

For example, a complete 4-channel system can be fitted into a flight case measuring only 6 U high (see below). Thanks to the integrated PSU 4000 power supply unit and the PS 4000 antenna splitter with two front antennas, all you need to do is connect a single power cable! All other components, such as the transmitters, can be stored in a 2 U drawer.



Specification:

	Amount	Item	Description
	10 x	SR 4000	True diversity receiver
	10 x	HT/PT 4000	Handheld or portable transmitter
	5 x	CU 4000	Charging unit
	1 x	PSU 4000	Central power supply
	3 x	PS 4000	Antenna splitter
	2 x	HPA 4000	Headphone amplifier
	2 x	SRA 2B	Active wideband directional antenna

- Power cable
- Antenna cable
- Audio cable

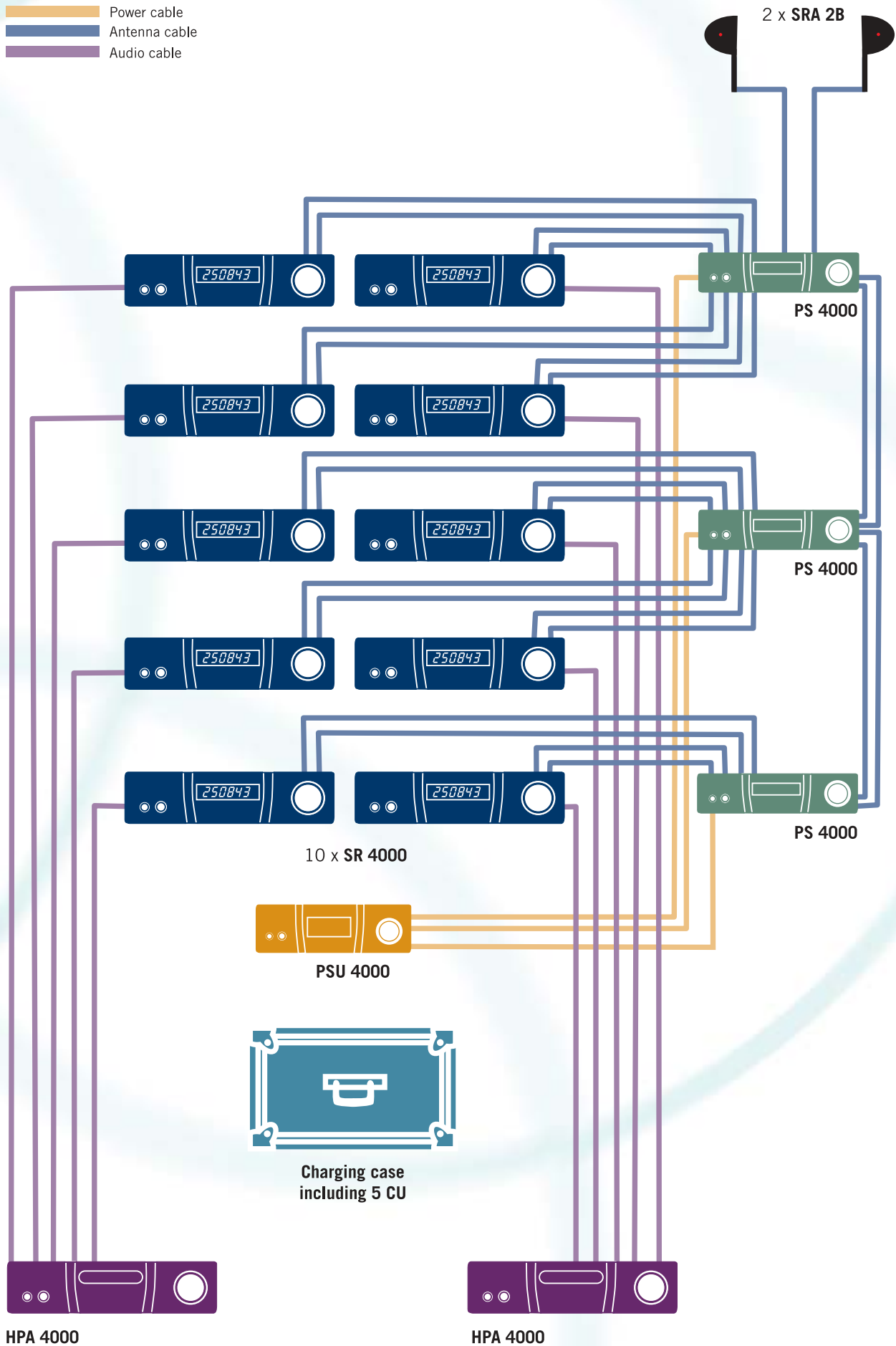

WMS 4000 16-CHANNEL SETUP

EXAMPLE: 16-CHANNEL SYSTEM FOR MOBILE USE

Although most venues are equipped with fixed wireless installations, special performances frequently require specific mobile systems. The reasons for this may vary, but the basic requirements are the same: a high-performance wireless system in a portable rack, whose audio signals can be fed to the local system simply through a multicore cable. Key prerequisites are minimum space requirements, quick cabling and clearly arranged controls.

Our example is a mobile 16-channel system for a musical performance. Apart from trans-

mitters and receivers, it comprises antenna splitters and power supply units, thus minimizing the necessary amount of antenna, power and DC cables.

Especially the amount of power feeder cables was substantially reduced, since four antenna splitters, 16 receivers and active antennas, as well as one spare antenna splitter and four spare receivers, were powered by only two PSU 4000 power supply units.

By daisy-chaining the antenna splitters, all antenna cable runs were kept within the

rack. Just two antenna cables and two power cables were connected to the rack. By comparison, the IVM 1 In-ear Monitor System also installed in the rack, with just two channels, needed the same amount of feeders as a 16 (or 20) channel wireless system.







Apart from the convenient and space-saving arrangement, this setup helped to achieve a pleasant "side effect" as it substantially reduced hum from power cables.

The Vienna Konzerthaus

Along with the Vienna State Opera and the Golden Musikvereinssaal (concert hall), the Vienna Konzerthaus is one of the most famous venues in Vienna. The Vienna Konzerthaus increasingly stages non-classical performances, such as musicals or rock concerts. Its many years of cooperation with AKG have resulted in optimum sound for widely differing requirements.

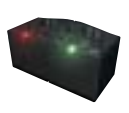

Specification:

	Amount	Item	Description
	16 x	SR 4000	True diversity receiver
	2 x	HT/PT 4000	Handheld or portable transmitter
	8 x	CU 4000	Charging unit
	4 x	PS 4000	Antenna splitter
	2 x	RA 4000 B	Omnidirectional wideband booster antenna
	2 x	AB 4000	Antenna booster
	2 x	ZAPD 21	Antenna combiner



WMS 4000 mobile rack

Front view of the rack. The receivers and antenna splitters are clearly visible. Hard to believe that all these components are powered by just two power supply units (see the three blue LEDs).

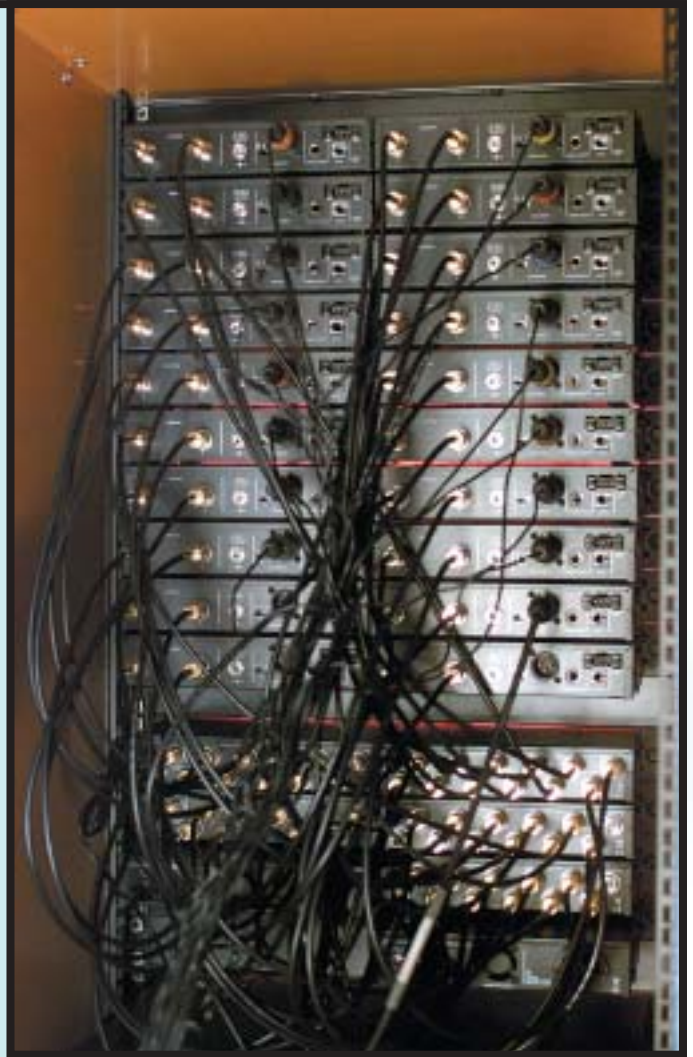

WMS 4000 Wiring

Even large systems do not have to drown in cable clutter. All cable runs are clearly visible, while the reduced number of cables helps diminish hum and improve heat dissipation from the rack.



Gala Musical Couples, August 2003

This performance was scheduled at short notice and therefore needed a high-performance mobile wireless system. The AKG WMS 4000 was the obvious answer.

The detailed system layout is shown on the following pages.

WMS 4000 16-CHANNEL SETUP

EXAMPLE: 16-CHANNEL SYSTEM FOR MOBILE USE

Antenna cable A
Antenna cable B

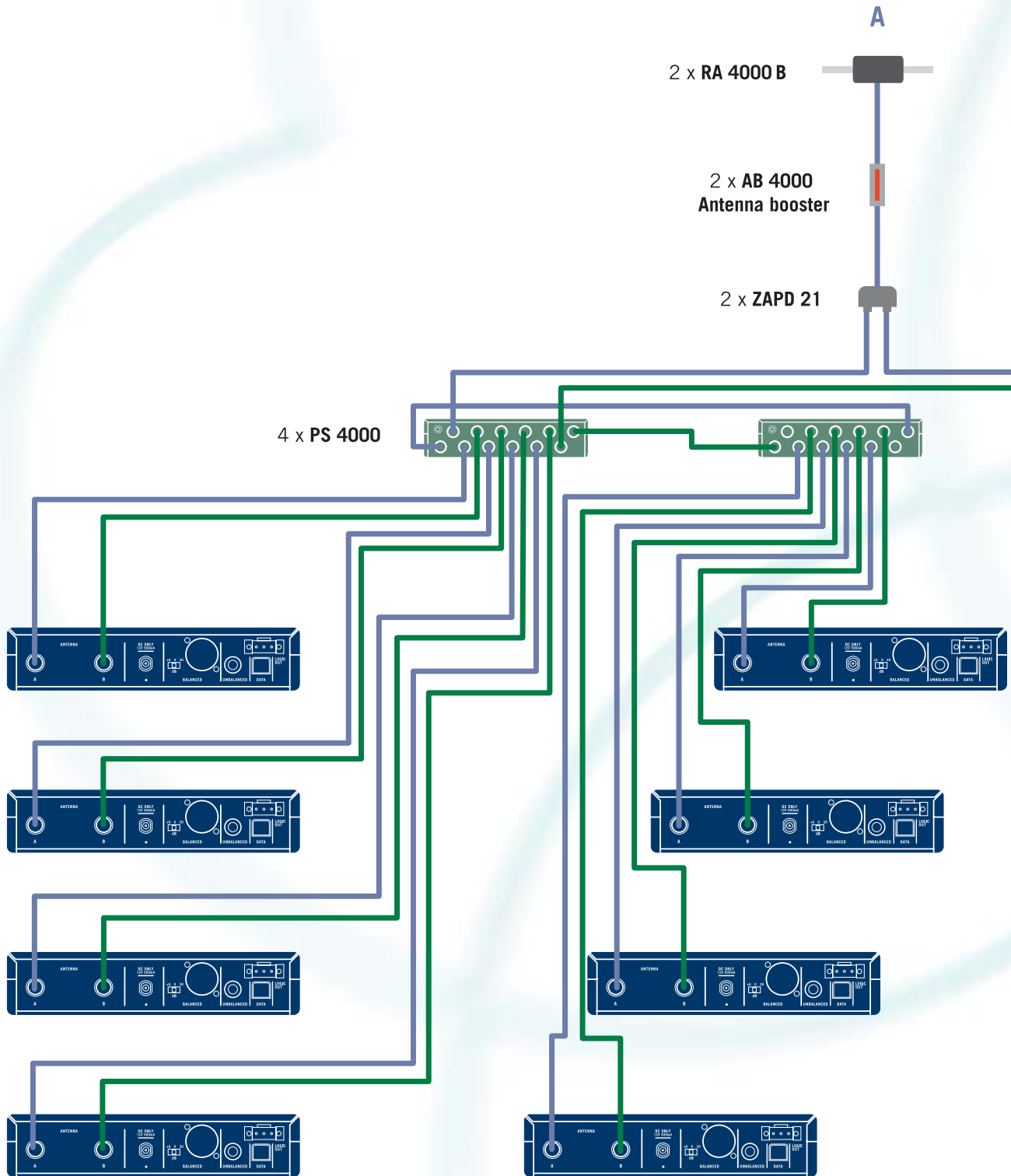

4 x SR 4000

4 x SR 4000

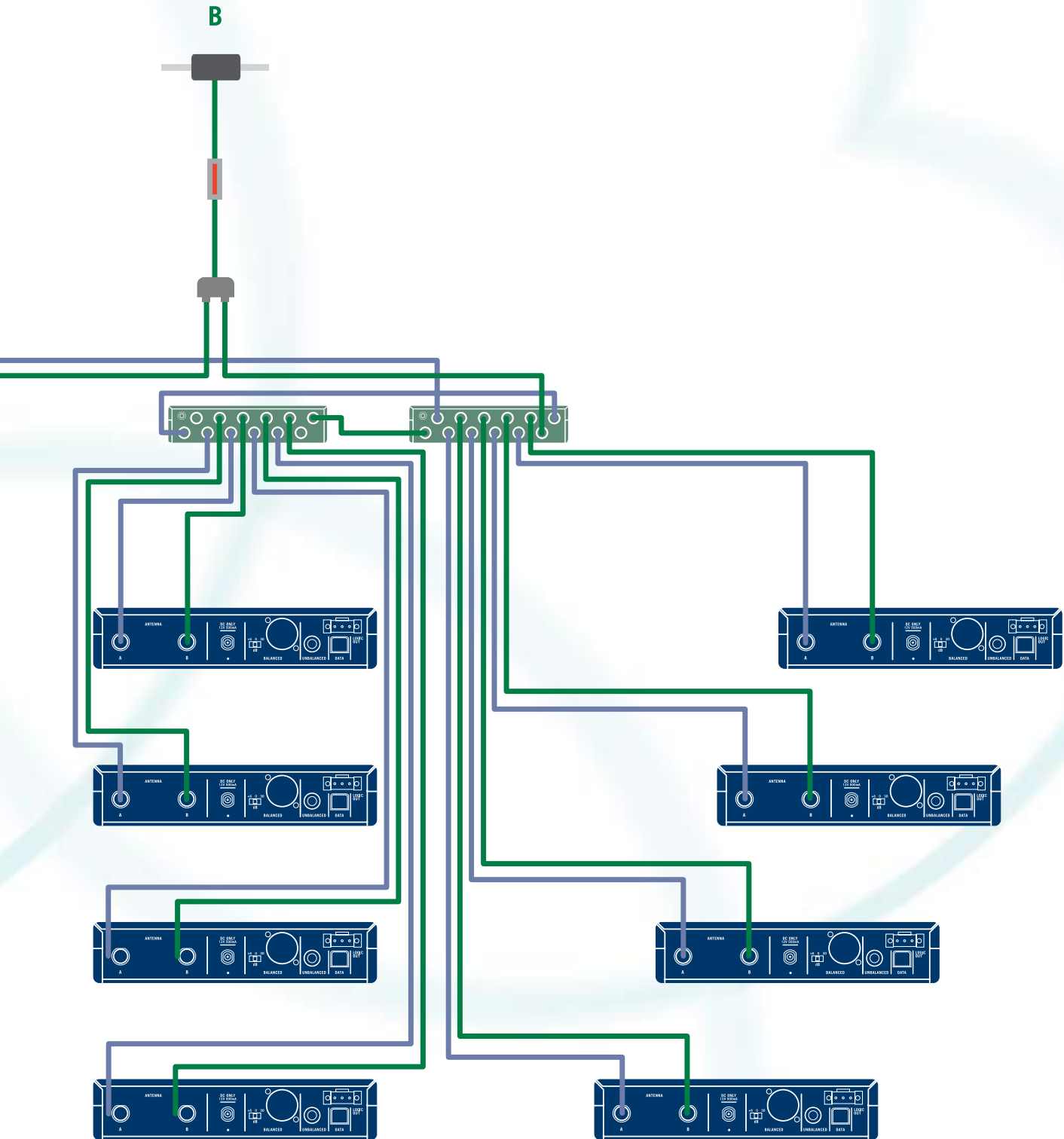

4 x SR 4000

4 x SR 4000

WMS 4000 46-CHANNEL SETUP

EXAMPLE: 46-CHANNEL SYSTEM FOR AN OPERA HOUSE

As regards planning, technology, and monitoring, wireless installations in opera houses pose a particular challenge. Unfailingly high sound quality and "invisible" installation of the components are basic requirements for offering the audience a unique auditory experience.

Structural issues pose much greater difficulties: as a rule, opera houses are historic buildings subject to strict conditions with regard to constructional alterations. And the numerous backstage rooms, such as dressing rooms, maintenance passages etc. are an environment

that is rather hostile to RF propagation. Above all, however, there is one feature typical of many opera houses: the so-called "iron curtain" that separates the stage and auditorium. A massive metal wall, it completely blocks radio signals when lowered.

In our case, we needed a 46-channel system centrally controlled from the control room. The stage was approx. 70 m (230 ft) away from the control room and had to be covered with the minimum possible number of antennas. Besides, the transmitters in the dressing room

had to be operational, so that the correct functioning and level settings could be tested prior to showtime.

The system uses two passive directional antennas placed close to the control room to cover the stage. Antenna combiners connect two omnidirectional booster antennas in the dressing room, which receive the radio signals from behind the stage. This ensures perfect transmission and monitoring of all transmitters even during intermissions, when the iron curtain is lowered.

High-tech for pure enjoyment

Every opera or theater audience has a right to enjoy exceptional artistic performances and excellent sound. Therefore, microphones and wireless components must not only work perfectly but be more or less invisible in order not to disrupt the visual appeal of the stage set and performers. The compact WMS 4000 and AKG MicroMics provide the ideal combination for this type of application.



Specification:

	Amount	Item	Description
	46 x	SR 4000	True diversity receiver
	46 x	HT/PT 4000	Handheld or portable transmitter
	25 x	CU 4000	Charging unit
	18 x	PSU 4000	Central power supply unit
	12 x	PS 4000	Antenna splitter
	2 x	RA 4000 B	Booster antenna
	2 x	SRA 2B	Active wideband directional antenna
	8 x	ZAPD 21	Antenna combiner

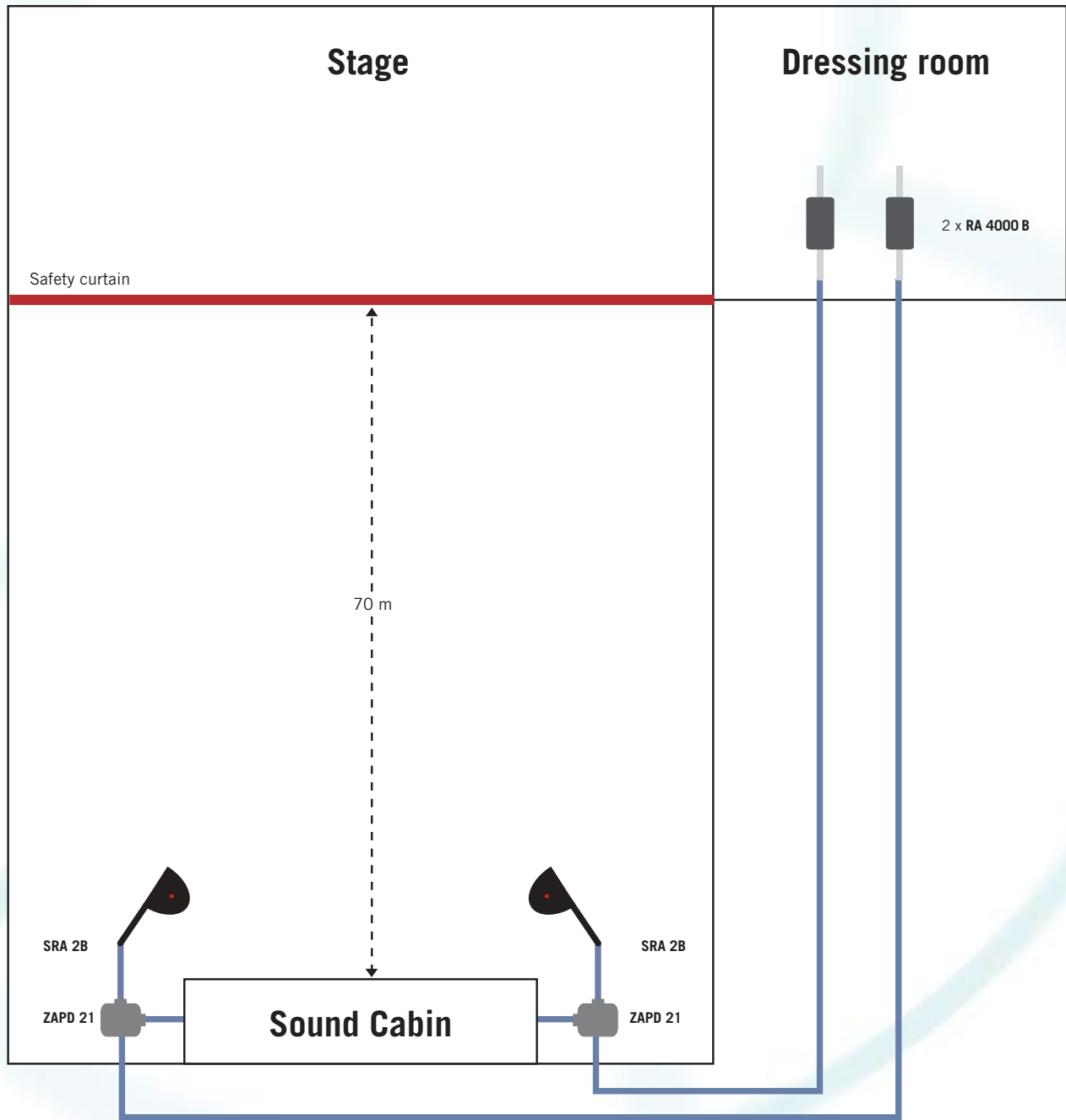

Antenna cable

WMS 4000 46-CHANNEL SETUP

EXAMPLE: 46-CHANNEL SYSTEM FOR AN OPERA HOUSE

- Antenna cable A
- Antenna cable B

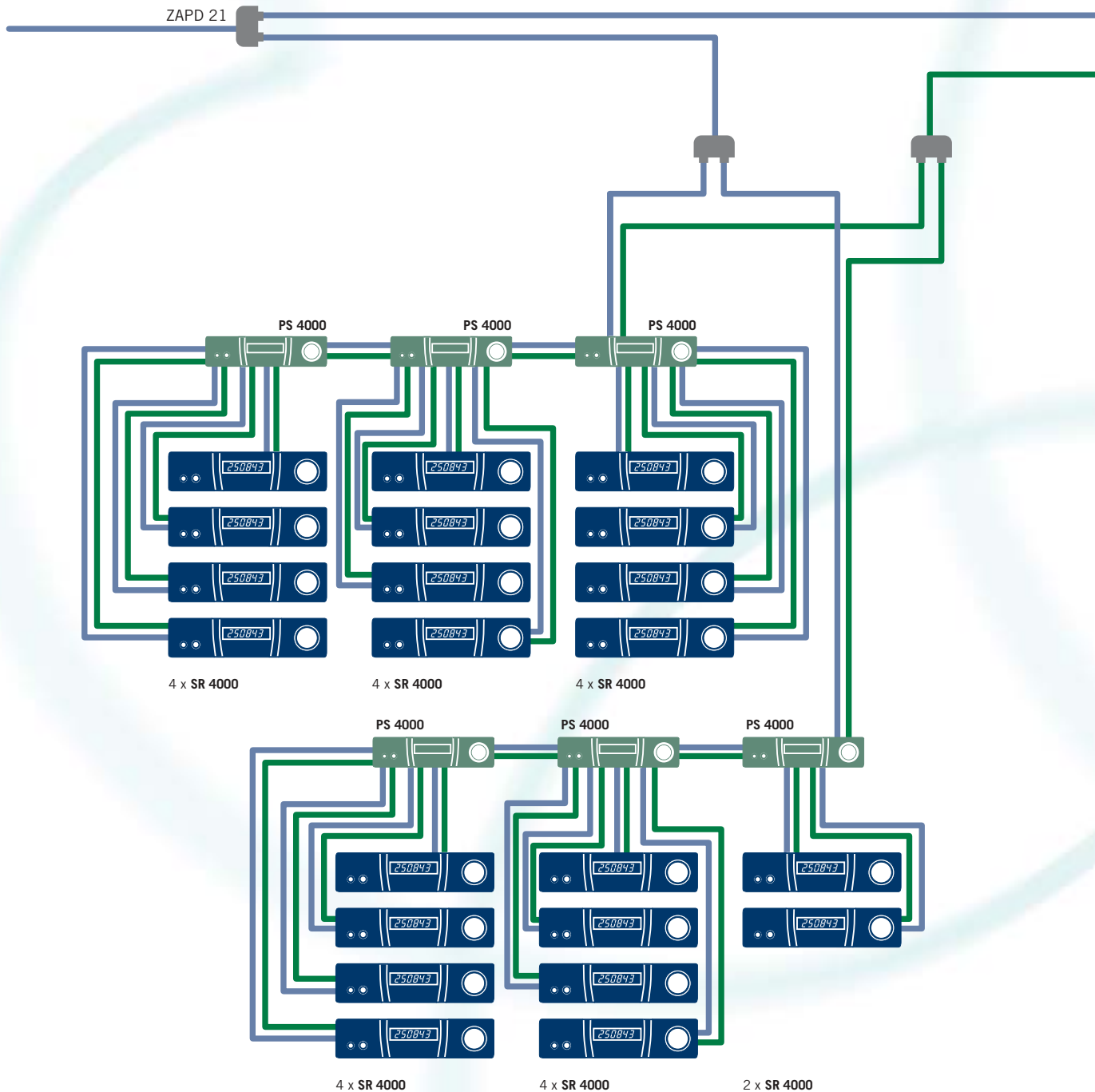

22 channels

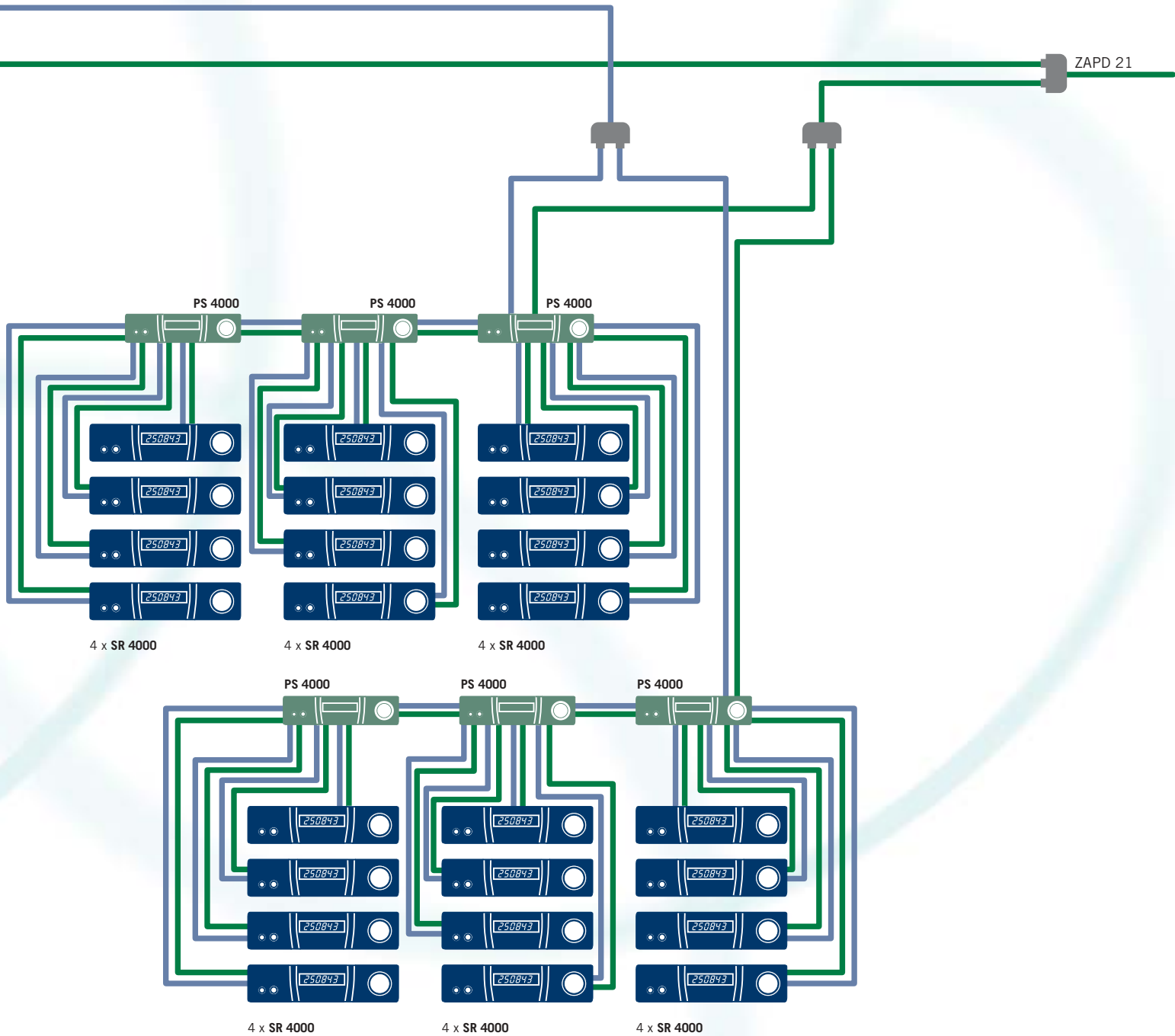

24 channels

WMS 4000 1-CHANNEL SETUP

EXAMPLE: 1-CHANNEL SYSTEM FOR SPECIFIC ARCHITECTURAL REQUIREMENTS

“The devil is in the details” is a saying that is very often true of wireless systems. Even if multichannel setups are no problem for the WMS 4000 thanks to frequency programs, Auto Setup etc., situations will arise where the greatest problem is not the number of channels but the correct design of a system with just one channel. Specific architectural conditions do not call for cutting-edge technology but rather for ingenious antenna positioning and the availability of small and helpful additional components required for a well-conceived system.







In this example, we needed a single-channel wireless system for a three-story reinforced-concrete building with an L- shaped plan. The task sounds simple: the transmitter must deliver a signal from any place on each floor.

The only way to solve this problem is to use long antenna cable runs and booster antennas. The latter are simply suspended from the ceiling at the junction between the two wings of the L-shaped plan. It is essential to pay attention to the layout and the distances between the antennas. Antenna combiners

connect the antenna cables from each floor to the receiver.

However, the cable runs to the last floor are too long for the receiver to supply enough power to the booster antennas. This problem can be solved by inserting an ASU 4000 remote feeding adapter and power supply into each antenna cable. The ASU 4000 is available with AC power supplies for a variety of AC voltages. A simple, inconspicuous and cost efficient solution that minimizes the number of required components.



Specification:			
	Amount	Item	Description
	1 x	SR 4000	True diversity receiver
	1 x	HT/PT 4000	Hendheld or portable transmitter
	2 x	ASU 4000	Remote powerd adapter for antennas
	6 x	RA 4000 B	Omnidirectional wideband booster antenna
	2 x	AB 4000	Antenna booster
	4 x	ZAPD 21	Antenna combiner

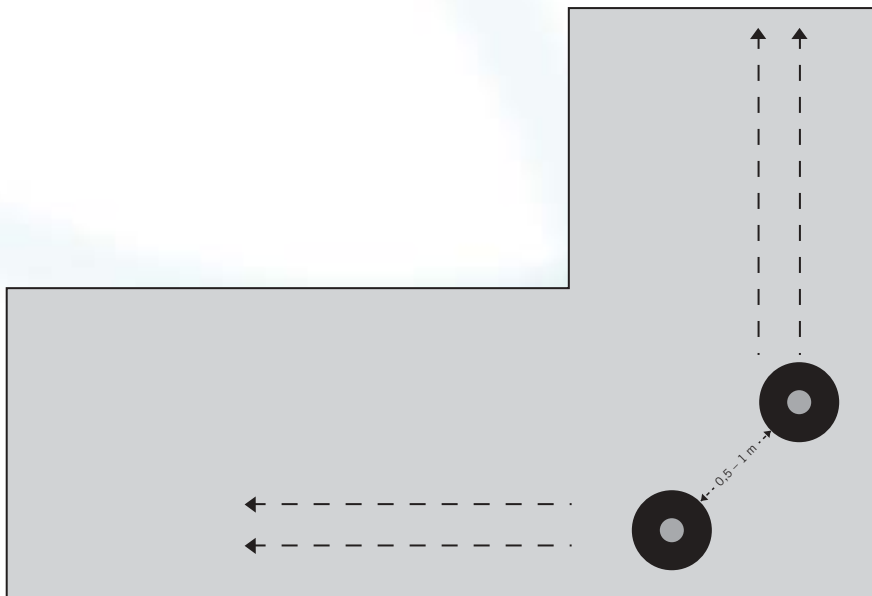
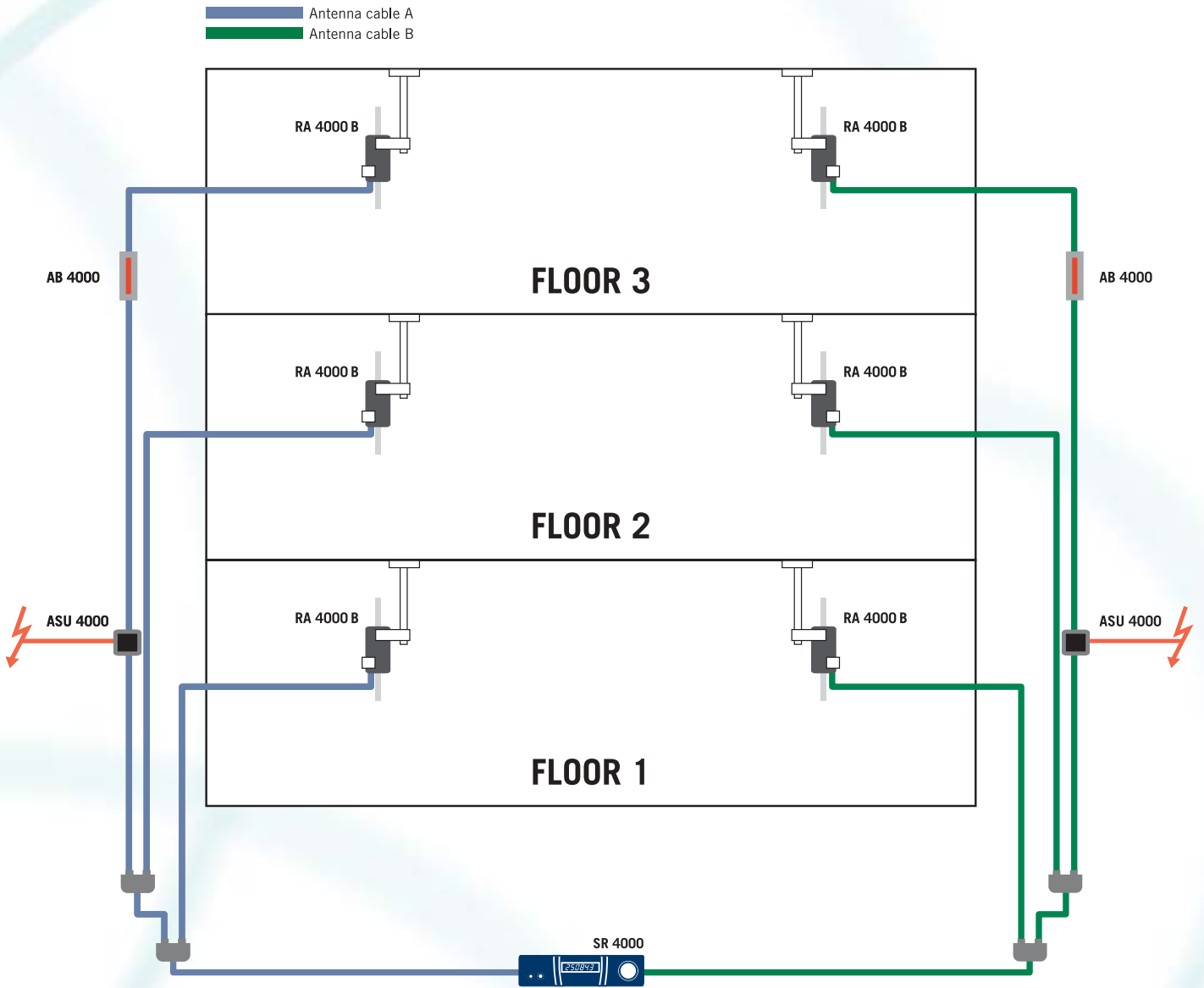

AKG MICRO MICS FOR INSTRUMENTS

HOW TO PLACE WIRELESS PICKUPS ON PORTABLE INSTRUMENTS — SOME USEFUL HINTS

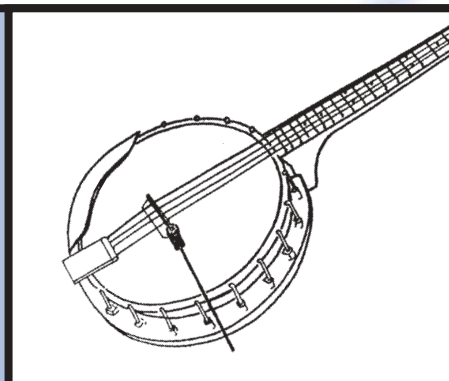
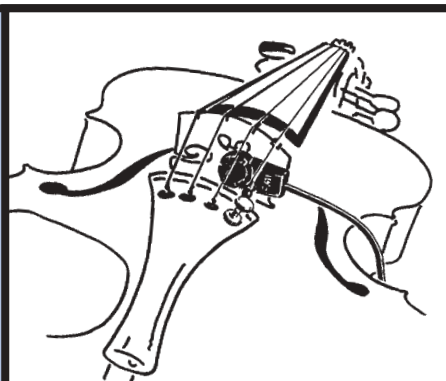
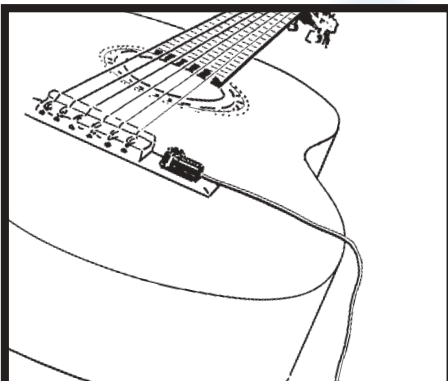

Guitar:

You may need to try around for the best spot to attach the C 411 L to your guitar. Attaching the microphone on or near the bridge will usually give an excellent sound. (top left)

Violin and viola:

Attach the C 411 L on or near the bridge and try out several positions. (top center)

Banjo:

See guitar. (top right)



Accordion:

For the bass section, place one C 416 close to a sound hole; direct another C 416 toward the treble section. (below left)

You can mix the sounds of the two microphones using the B 29 L battery power supply and mini-mixer. (below right)

Attach each C 416 to the accordion using an H 416 mounting bracket which comes complete with double-sided adhesive rubber pads to fix it onto the instrument. If required (for transport etc.), the microphones can be easily detached and snapped into place again later. The combination of strap and mounting bracket ensures easy handling and stable positioning. (below center)

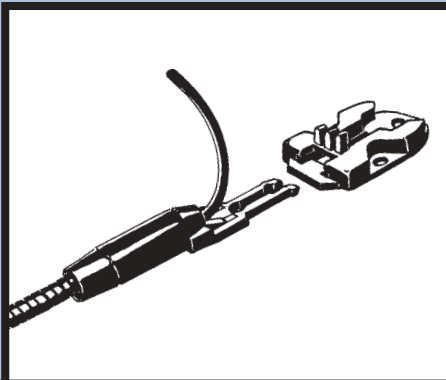

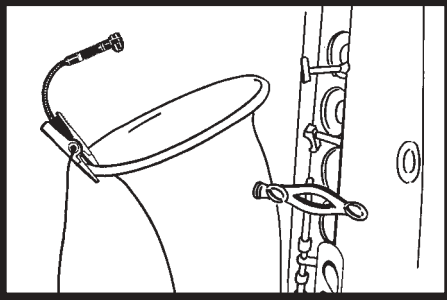

Saxophone:

Clip the C 419 L or D 409 on to the bell of the saxophone, align it with the edge and listen to the sound to identify the best position. For subtone playing, turn the microphone toward the center of the bell (marked wind noise!).

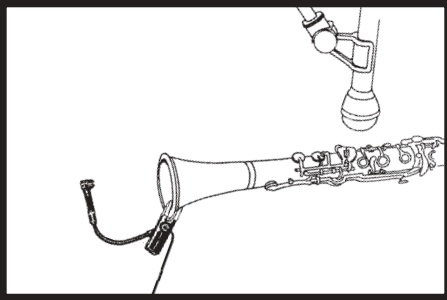

Clarinet:

Always use two microphones. Direct one microphone (e.g., C 535 or C 5900) toward the keys, the other toward the bell – the C 419 L or D 409 are ideally suited for this purpose.

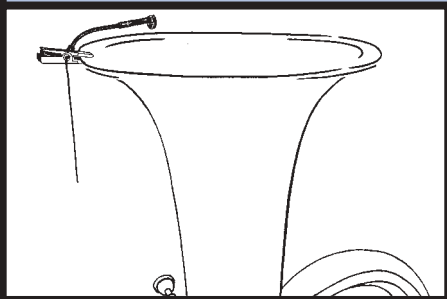

Tubas:

Clip the C 419 L or D 409 on to the bell of the instrument, and try out different positions. If you get a lot of wind noise, adjust the microphone to align with the edge or use a wind-screen.

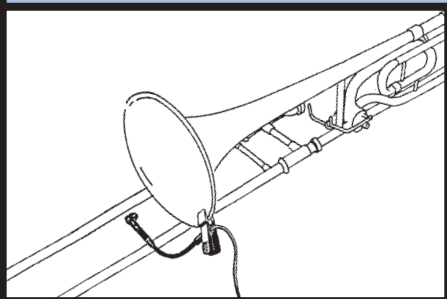

Trombone:

Clip the C 419 L or D 409 on to the bell of the trombone, and try out different positions to identify the ideal one. When playing with a mute, bend the gooseneck out of the "danger area."

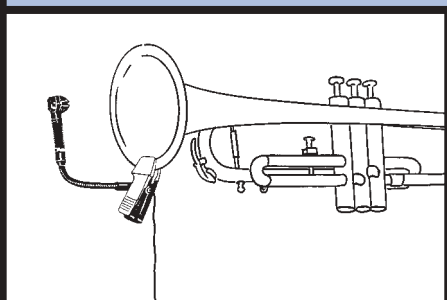
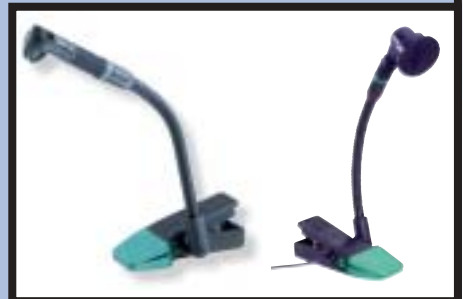

Trumpet:

Clip the C 419 L or D 409 on to the bell of the trumpet. Use the gooseneck to position the microphone as far away from the instrument as possible, but turn it toward the bell. The ultimate sound will depend on the microphone position – just try it out!

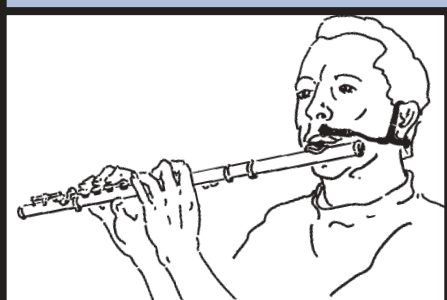

Flute:

Direct the C 420 L toward the embouchure. Slightly turn to one side to reduce wind noise if necessary.



APPLICATION GUIDE

RECOMMENDED AKG WIRELESS SYSTEMS FOR SELECTED APPLICATIONS

Application	Budget	Professional	Premium
AV/sound company	PT 40/TM 40	HT 400, C 900/D 880, PT 400/C 444	HT 4000, D 3800/C 900, PT 4000/C 420
Bars and clubs	HT 40/TM 40, PT 40/C 444	HT 400, C 900/D 880, PT 400/C 420	HT 4000, D 880/C 900, PT 4000/C 420
Sound systems (shopping malls, universities, etc.)	HT 40/TM 40, PT 40, CK 55, MP 40	HT 400/D 880, PT 400/C 417	HT 4000/D 3700, PT 4000/CK 97
Meeting and social rooms	HT 40/SO 40, PT 40, CK 55/C 444	HT 400/D 880, PT 400, C 417/C 444	HT 4000/D 3700, PT 4000/C 444
Fitness centers and recreational facilities	PT 40/C 444	PT 400/C 444	
Hotels	HT 40/TM 40, PT 40/CK 55	HT 400/D 880, PT 400/CK 55	HT 4000, D 880, PT 4000, C 417
Karaoke	HT 40/TM 40	HT 400/D 880	
Places of worship	PT 40/CK 55, HT 40	PT 400/CK 97, HT 400, D 880/C 900	PT 4000, CK 77, HT 4000, D 3800, C 535, C 5900
Conference rooms Conference centers	HT 40, PT 40/CK 55, MP 40	HT 400, D 880, PT 400, C 417/C 444	HT 4000, D 3800/C 5900, PT 4000, CK 77/C 420
Live sound	PT 40/C 444, GB 40, HT 40/TM 40	PT 400/MK GL/C 444, HT 400/D 880	HT 4000, D 880/D 3800/ C 535/C 5900
Multipurpose halls	PT 40/C 444, GB 40, HT 40/TM 40	PT 400/MK GL/C 444, HT 400/D 880	HT 4000, D 880/D 3800/ C 535/C 5900
Open-air sound systems (sports events, etc.)	PT 40/C 444, GB 40, HT 40/TM 40	PT 400/MK GL/C 444, HT 400/D 880	HT 4000, D 880/D 3800/ C 535/C 5900
Presentations	HT 40/TM 40, PT 40/CK 55	HT 400/D 880, PT 400/CK 55	HT 4000, D 880, PT 4000, C 417
Schools, clubs, etc.	HT 40/TM 40, PT 40, CK 55, MP 40	HT 400/D 880, PT 400/C 417	HT 4000/D 3700, PT 4000/CK 97
Theater/music	PT 40/C 444	PT 400/C 444, HT 400/D 880, CK 77, C 900	PT 4000, CK 77/C 477, HT 4000, C 5900/C 535, D 3800
Theater/speech	PT 40/C 417, HT 40	PT 400/CK 47, HT 400/D 880	PT 4000, CK 77/C 477, HT 4000/D 3700
Tour sound	PT 40/C 444, GB 40, HT 40/TM 40	PT 400/MK GL/C 444, HT 400/D 880	HT 4000, D 880/D 3800/ C 535/C 5900
TV studio productions	PT 40/C 417, HT 40	PT 400/CK 97, HT 400, C 900/D 880	PT 4000/CK 77, HT 4000, D 3800/C 5900/ C 535

AKG WMS OVERVIEW

AKG WIRELESS SYSTEMS AT A GLANCE

Receiver	PR 40	SR 40	SR 40 diversity	SR 400	SR 4000
Diversity	■		■	■	■
Backlit display				■	■
Diversity indicators			■	■	■
RF/audio level LED			■	■	■
RF/audio bargraphs w/peak hold				■	■
Mute LED	■	■	■	■	■
Peak LED	■		■	■	■
Programmable status display				■	■
Adjustable squelch		■		■	■
Tone code squelch					■
Selectable frequencies				■	■
Integrated country-coded frequency database				■	■
Frequency presets	1	1	1	12	18
Max. number of simultaneous channels*	6	6	8	50	> 50
Auto setup function				■	■
Infrared data transmission				■	
Rehearsal function				■	■
Environment Scan function					■
Adjustable scan threshold					■
Transmitter battery status display				■	■
Transmitter battery capacity readout					■
Programmable name				■	■
Color code	■	■	■	■	■
Menu keys				■	
Setup control					■
Balanced XLR output		■	■	■	■
Unbalanced 1/4" output jack	■	■	■	■	■
Adjustable audio-output	■	■	■	■	■
Mic/line selector				■	■
Fixed front panel antennas	■	■	■		
BNC antenna sockets				■	■
Computer interface					■
Logic output					■
Lockable DC input				■	■
All-metal case			■	■	■
Rack mounting kit included				■	■
Optional rack mounting kit		■	■		
Optional antenna splitter				■	■
Optional directional antennas				■	■
Optional booster antennas				■	■
Central power supply (optional)				■	■
Headphone amplifier (optional)				■	■
Network concentrator (optional)					■
Remote control software (optional)					■

*The maximum number of channels that can be used simultaneously depends on local frequency allocations.

Transmitter	Microtools	HT/PT 40	HT/PT 400	HT/PT 4000
Backlit LC display				■
LC display			■	
Integrated frequency database			■	■
Mechanical gain control	■	PT	PT	
Gain control pot				■
Audio bargraph				■
Auto gain setup				■
Jog switch				■
Pilot tone data transmission			■	■
Infrared radiator			■	
Programming contacts				■
Charging contacts	■		■	
Batteries	1 x 1.5 V AAA	2 x 1.5 V AA	1 x 1.5 V AA	1 x 1.5 V AA
Intelligent battery pack (optional)				■
Battery life (dry batteries)	typ. 8 h	typ. 35 h	typ. 6 h	typ. 15 h
Battery life (rechargeable batteries)	typ. 6 h		typ. 8 h	typ. 12 h
Battery status indicator	■	■	■	■
Battery capacity readout			■	■
Max. RF output	10 mW	10 mW	50 mW	50 mW
On/mute/off switch	■	■	■	
Electronically lockable on/off key				■
Mute switch				■
Switch cover for handheld transmitter (optional)				■
Remote mute switch for bodypack transmitter			■	■
Interchangeable microphone elements for handheld transmitter				■
Color code	■	■	■	■
Lettering field			■	■
Charger (optional)	■		■	■

SPECIFICATIONS

ALL THE SPECS AT A GLANCE

System	SR 40	SR 40 diversity	HT 40	PT 40	SO 40 snapon	GB 40 guitarbug	MP 40 micropen
Carrier frequency band:	710-865 MHz	710-865 MHz	710-865 MHz	710-865 MHz	710-865 MHz	710-865 MHz	710-865 MHz
Modulation:	FM	FM	FM	FM	FM	FM	FM
Audio bandwidth:	40-20.000 Hz	40-20.000 Hz	40-20.000 Hz	40-20.000 Hz	40-20.000 Hz	40-20.000 Hz	40-20.000 Hz
THD (1 kHz/rated deviation):	typ. 0.8%	typ. 0.8%	typ. 0.8%	typ. 0.8%	typ. 0.8%	typ. 0.8%	typ. 0.8%
S/N (A-weighted):	typ. 103 dB	typ. 103 dB	typ. 103 dB	typ. 103 dB	typ. 103 dB	typ. 103 dB	typ. 103 dB
Power requirement:	120/230 V AC, 50/60 Hz, 95±15 mA	120/230 V AC, 50/60 Hz, 95±15 mA	2 x 1,5 V AA size batteries	2 x 1,5 V AA size batteries	1 x 1,5 V AAA size battery	1 x 1,5 V AAA size battery	1 x 1,5 V AAA size battery
Audio outputs:	balanced XLR and 1/4" TX jack, level adjustable from mic to line, 2 V rms max.	balanced XLR and 1/4" TX jack, level adjustable from mic to line, 2 V rms max.	—	—	—	—	—
Battery life:	—	—	>35 hours (2 AA size dry batteries)	>35 hours (2 AA size dry batteries)	> 10 hours (AAA size dry battery); > 5 hours (rechargeable battery)	> 11 hours (AAA size dry battery); > 6 hours (rechargeable battery)	> 10 hours (AAA size dry battery); > 5 hours (rechargeable battery)
RF output:	—	—	typ. 10 mW (ERP)	typ. 10 mW (ERP)	typ. 5 mW (ERP)	5 mW (ERP)	typ. 5 mW (ERP)
Size:	235 x 142 x 43 mm	200 x 135 x 42 mm	40 ø x 258 mm	96 x 64 x 22 mm	22 x 30 x 98 mm	76 x 20 x 28 mm	20 x 25 x 145 mm
Weight:	470 g	470 g	245 g	76 g	36 g	28 g	36 g
Standard accessories:	12 V power supply	12 V power supply	2 AA size batteries, black color code clip, stand adapter	2 AA size batteries, belt clip	1 AAA size battery, black battery compartment cover	long adapter plug, 1 AAA size battery, black battery compartment cover, 2 Velcro strips	1 AAA size battery, black replacement clip, necklace cord
Optional accessories:	CH 40 carrying case, MK 9/10, RMU 40 rack mounting kit	CH 40 carrying case, MK 9/10, RMU 40 rack mounting kit	W 880	CB 40 neoprene bag	CU 40 charger	CU 40 charger	CU 40 charger

Wireless microphones and microphone elements

D 880 WL 1

Frequency range: 60-20,000 Hz
 Polar pattern: Hypercardioid
 Sensitivity: 2.5 mV/Pa (-52 dBV)
 Electrical impedance: ≤ 600 ohms Ω
 Max. SPL for 1% THD: 147 dB-SPL
 Size: 50 ø / x 180 mm
 Net/shipping weight: 290/650 g

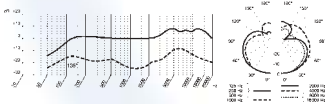

D 3700 WL 1

Frequency range: 60-18,000 Hz
 Polar pattern: Hypercardioid
 Sensitivity: 2.5 mV/Pa (-57 dBV)
 Electrical impedance: ≤ 600 ohms Ω
 Equivalent noise level: 22 dB-A (DIN 45412)
 Max. SPL for 3% THD: 147 dB-SPL
 Size: 46.2 ø x 185.5 mm
 Net/shipping weight: 240/640 g

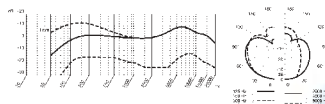

D 3800 WL 1

Frequency range: 14-21,000 Hz
 Polar pattern: Hypercardioid
 Sensitivity: 2.8 mV/Pa (-51 dBV)
 Electrical impedance: ≤ 600 ohms Ω
 Equivalent noise level: 22 dB-A (DIN 45412)
 Max. SPL for 3% THD: 156 dB-SPL
 Size: 53 ø x 187.5 mm
 Net/shipping weight: 276/676 g

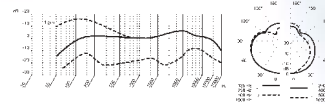

D 5900 WL 1

Frequency range: 20-22,000 Hz
 Polar pattern: Hypercardioid
 Sensitivity: 6 mV/Pa (-64 dBV)
 Electrical impedance: < 200 ohms Ω
 Equivalent noise level: 74 dB-A (DIN 45412)
 Size: 53 ø / x 187.5 mm
 Net/shipping weight: 276/676 g

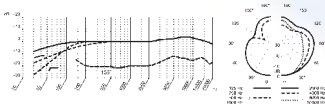

C 411 L

Frequency range: 10-18,000 Hz
 Polar pattern: vibration pickup
 Sensitivity: 1 mV/ms²
 Electrical impedance: ≤ 200 ohms Ω
 Max. SPL for 1% THD: 100 dB-SPL
 Size: 27 x 14 x 9.5 mm
 Net/shipping weight: 18/225 g

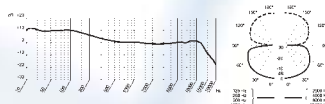

C 416 L

Frequency range: 20-20,000 Hz
 Polar pattern: Hypercardioid
 Sensitivity: 5 mV/Pa (-46 dBV)
 Electrical impedance: ≤ 200 ohms Ω
 Max. SPL for 1% THD: 126 dB-SPL
 Size: 235 x 30 mm
 Net/shipping weight: 120/455 g

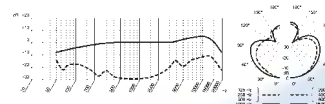

C 417 L

Frequency range: 20-20,000 Hz
 Polar pattern: Omni-Directional
 Sensitivity: 10 mV/Pa (-40 dBV)
 Electrical impedance: ≤ 200 ohms Ω
 Max. SPL for 1% THD: 118 dB-SPL
 Size: 7.5 x 15 mm
 Net/shipping weight: 8/160 g

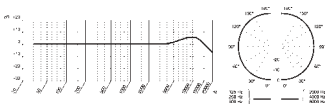

C 419 L

Frequency range: 20-20,000 Hz
 Polar pattern: Hypercardioid
 Sensitivity: 5 mV/Pa (-46 dBV)
 Electrical impedance: ≤ 200 ohms Ω
 Max. SPL for 1% THD: 126 dB-SPL
 Size: 180 ø x 35 mm
 Net/shipping weight: 77/462 g

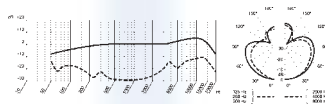

C 420 L

Frequency range: 20-20,000 Hz
 Polar pattern: Cardioid
 Sensitivity: 46 mV/Pa (-46 dBV)
 Electrical impedance: ≤ 200 ohms Ω
 Max. SPL for 1% THD: 126 dB-SPL
 Size: 130 mm
 Net/shipping weight: 30/540 g

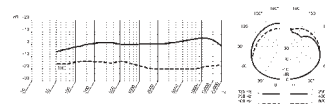

SPECIFICATIONS

ALL THE SPECS AT A GLANCE

	TM 40	PR 40 diversity	SR 400	HT 400	PT 400	SR 4000	HT 4000	PT 4000
	710-865 MHz	710-865 MHz	650-680, 680-710, 720-750, 760-790, 790-820 and 835-863 MHz	650-680, 680-710, 720-750, 760-790, 790-820 and 835-863 MHz	650-680, 680-710, 720-750, 760-790, 790-820 and 835-863 MHz	650-680, 680-710, 720-750, 760-790, 790-820 and 835-863 MHz	650-680, 680-710, 720-750, 760-790, 790-820 and 835-863 MHz	650-680, 680-710, 720-750, 760-790, 790-820 and 835-863 MHz
	FM	FM	FM	FM	FM	FM	FM	FM
	40-20.000 Hz	40-20.000 Hz	35-20.000 Hz	35-20.000 Hz	35-20.000 Hz	35-20.000 Hz	35-20.000 Hz	35-20.000 Hz
	typ. 0,8%	typ. 0,8%	typ. <0,3%	typ. <0,7%	typ. <0,7%	typ. <0,3%	typ. <0,3%	typ. <0,3%
	typ. 103 dB	typ. 103 dB	typ. >120 dB	typ. >120 dB	typ. >120 dB	typ. >120 dB	typ. >120 dB	typ. >120 dB
	1 x 1,5 V AAA size battery	2 x 1,5 V AAA size batteries	–	–	–	–	–	–
	–	unbal. line (tip): +6 dBm (10 kohms); headphones (ring): typ. 18 mW (15 ohms), typ. 13 mW (100 ohms)	balanced XLR and 1/4" TX jack; level switchable to -30 dBm or 0 dBm	–	–	balanced XLR and 1/4" TX jack; level switchable to -30, 0, or +6 dB	–	–
	> 10 hours (AAA size dry battery); > 6 hours (rechargeable battery)	> 8 hours (dry batteries); > 6 hours (rechargeable batteries)	–	typ. 6 hours (AA size dry battery) or typ. 8 hours (1.2 V AA size, 2100 mAh rechargeable battery)	typ. 6 hours (AA size dry battery) or typ. 8 hours (1.2 V AA size, 2100 mAh rechargeable battery)	–	typ. 15 hours (2 AA size dry batteries) or typ. 12 hours (BP 4000 battery pack)	typ. 15 hours (2 AA size dry batteries) or typ. 12 hours (BP 4000 battery pack)
	typ. 5 mW (ERP)	typ. 5 mW (ERP)	–	50 mW (ERP) max.	50 mW (ERP) max.	–	30 mW (ERP) max.	30 mW (ERP) max.
	26 ø x 125 mm	77 x 55 x 15 mm	200 x 190 x 44 mm	229 x max. ø 52,5 mm	60 x 73,5 x 30 mm	200 x 190 x 44 mm	39 ø x 239 mm	70 x 90 x 25 mm
	30 g	60 g	972 g	220 g	90 g	972 g	320 g	320 g
	1 AAA size 1.5 V battery, color code battery compartment cover, screwdriver	audio connecting cable, 2 AAA size batteries, belt clip, Velcro strips for camera mounting	power supply, RMU 400 rack mounting kit, 2 antennas	1 AAA size 1.5 V battery, SA 63 stand adapter	1 AAA size 1.5 V battery, belt clip	power supply, RMU 4000 rack mounting kit, color coding kit, 2 antennas	SA 63 stand adapter, 2 AA size batteries, color coding kit	belt clip, 1 AAA size 1.5 V battery, color coding kit
	CU 40 charger	CU 40 charger, PA 40 remote powering adapter	–	–	remote mute switch	MK 9/10	–	remote mute switch

Wireless microphones and microphone elements

CK 31

Type: prepolarized condenser microphone
Frequency range: 50-20,000 Hz
Polar pattern: Cardioid
Sensitivity: 20 mV/Pa (-34 dBV)
Electrical impedance: ≤ 600 ohms Ω
Powering: 9 to 52 V phantom power - requires DPA adapter (integrated in GN and HN Installation Modules)
Size: 13 ø x 25 mm
Features/applications: modular microphone system for conferencing, theaters, places of worship, and many other applications

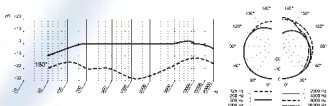

CK 32

Type: prepolarized condenser microphone
Frequency range: 20-20,000 Hz
Polar pattern: Omni-Directional
Sensitivity: 14 mV/Pa (-37 dBV)
Electrical impedance: ≤ 600 ohms Ω
Powering: 9 to 52 V phantom power - requires DPA adapter (integrated in GN and HN Installation Modules)
Size: 13 ø x 25 mm
Features/applications: modular microphone system for conferencing, theaters, places of worship, and many other applications

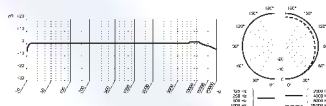

CK 33

Type: prepolarized condenser microphone
Frequency range: 50-20,000 Hz
Polar pattern: Hypercardioid
Sensitivity: 20 mV/Pa (-34 dBV)
Electrical impedance: ≤ 600 ohms Ω
Powering: 9 to 52 V phantom power - requires DPA adapter (integrated in GN and HN Installation Modules)
Size: 13 ø x 25 mm
Features/applications: modular microphone system for conferencing, theaters, places of worship, and many other applications

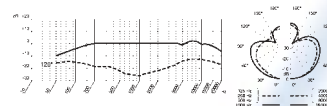

CK 77

Frequency range: 20-20,000 Hz
Polar pattern: Omni-Directional
Sensitivity: 46 mV/Pa (-27 dBV)
Electrical impedance: ≤ 3500 ohms Ω
Signal/noise ratio (A-weighted): 68 dB
Size: 5,5 ø x 14 mm
Net weight: 0,4 g

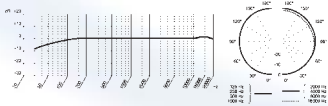

CK 55 L

Type: prepolarized condenser microphone
Frequency range: 150-18,000 Hz
Polar pattern: Cardioid
Electrical impedance: 200 ohms Ω
Powering: 1,5 to 10 V or 9 to 52 V phantom power to DIN 45596 via MPA III L adapter
Size: 8 ø x 23 mm

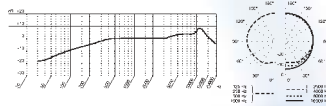

C 477 L

Frequency range: 20-20,000 Hz
Polar pattern: Omni-Directional
Sensitivity: 8 mV/Pa (-42 dBV)
Electrical impedance: 3500 ohms Ω
Signal/noise ratio (A-weighted): 68 dB
Size: 180 x 130 x 85 mm
Net weight: 15 g

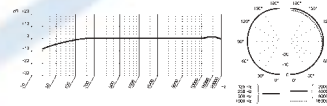

C 444 L

Type: prepolarized condenser microphone
Polar pattern: Cardioid
Frequency range: 20-20,000 Hz
Sensitivity: 40 mV/Pa (-28 dBV)
Electrical impedance: 200 ohms Ω
Recommended load impedance: > 2,000 ohms
Equivalent noise level: 22 dB-A
Max. SPL for 1%/3% THD: 126/130 dB-SPL
Powering: 1 VDC - 10 VDC
Current Consumption: 0,2 mV
Environment: 99% R.H. at 20°C
Materials: headband: metal, microphone body: Noryl
Finish: matte black
Size: 145 (L) x 110 (W) x 70 (H)
Cable length: approx. 1,5 m
Net weight: 30g without cable
Connector: 3-pin mini XLR

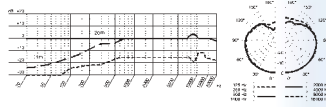

C 535 WL 1

Frequency range: 20-20,000 Hz
Polar pattern: Cardioid
Sensitivity: 7 mV/Pa (-43 dBV)
Electrical impedance: ≤ 200 ohms Ω
Signal/noise ratio (A-weighted): 75 dB
Max. SPL for 1% THD: 137 dB-SPL
Size: 46 x 184 mm
Net/shipping weight: 300/800 g

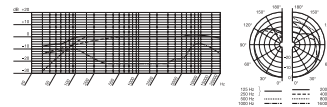

GLOSSARY

DEFINITIONS FROM A TO Z

Antenna Cable

Cable specifically designed for RF signals. Used for connecting a remote antenna to a receiver. Antenna cables are typically coaxial and symmetrical. Signal attenuation depends on the frequency band of the signal as well as the length and quality of the cable and is quoted for a 100-m run of cable.

Antenna Splitter

Electronic network specifically designed for RF signals. Distributes an antenna output signal to several receivers. Powered antenna splitters use an amplifier to compensate for cable attenuation while passive antenna splitters have no amplifier.

Balanced/Unbalanced Connections

Microphones can be connected to an amplifier with either balanced or unbalanced cables. In a balanced cable, the signal is carried by the two inner conductors and the shield is not part of the signal path. Even with long cable runs, any external interference signal (such as power line hum) would be induced equally in both conductors and thus be canceled. Unbalanced cables use only one center conductor as the "hot" wire, the shield being the ground ("cold") lead. While this arrangement works well with cables up to 10 meters in length low-frequency, long-wave hum interference may be picked up by longer cables which act as a long-wave antenna.

BNC

Connector specifically designed for RF lines.

Booster

Amplifier for RF signals. Boosters are connected between a transmitter output and the antenna in order to increase radiated power (custom product).

Condenser Microphone

The transducer element consists of a vibrating diaphragm (metalized foil) only about

a ten thousandth of an inch thick and a fixed metal electrode (back plate). The two electrodes make up a capacitor (condenser) charged by an externally applied DC voltage or carrying its own permanent charge. The sound waves driving the diaphragm will vary the capacitance of the capacitor and consequently the microphone output voltage will vary in step with the sound waves.

Condenser microphones, also called "capacitor microphones", need an impedance converter (preamplifier) to match the very-high-impedance condenser transducer to low-Z inputs. Condenser microphones usually have a flat frequency response, high sensitivity, and good transient response. They require a power supply. All AKG condenser microphones are designated by the letter(s) "C" or "CK" in front of the model number.

Connecting AKG Microphones

All handheld microphones listed in this catalog are low-impedance 1200 to 620 incorporating a balanced output on a 3-pin male XLR connector. Conforming to IEC 268-12, pin 1 is ground, pin 2 high, and pin 3 low. The output is compatible with all mixers, tape recorders, etc.

To connect an AKG microphone to an input jack, wire the microphone cable as follows: connect the sleeve of the jack plug (ground) to the cable shield and the shield to pins 1 and 3 on the XLR connector. The center ("hot") wire connects pin 2 to the jack plug tip (see diagram1).

If your installation uses pin 3 as "high" or "hot", bridge pins 1 and 2 for unbalanced connections and make sure to follow the same convention for all cables in order to avoid phase reversal problems.

Very old sound systems sometimes have high-impedance microphone inputs.

Should the signal of a low-impedance microphone be too weak, insert a 1:10 step-up transformer at the amplifier input. Long cable runs used with high-impedance equipment cause high-frequency loss. The same applies if you connect a microphone to a high-impedance guitar amplifier input.

Connecting Condenser Microphones

Condenser microphones - except for the battery powered C 1000 S - require an operating voltage that needs to be fed through the microphone cable (phantom powering). This can be done in several ways:

1. From a mixer with built-in phantom power (9 to 52 V).
2. By modifying the mixer or tape recorder to provide phantom power: find a regulated DC voltage between 9 and 52 V in the power supply. All modern AKG condenser microphones accept any voltage within this range. Wire the input(s) as shown. Current consumption of the phantom circuit is negligible (about 1 mA per mic). Replace the input jacks with XLR sockets if possible. While stereo jacks will work as well, there may be a risk of mistaking them for send/returns or the like.

Use the following standard resistances (IEC 26815) for R_V :

Voltage	Resistance
12 V (± 2 V)	680 Ω $\pm 10\%$
24 V (± 4 V)	1.2 k Ω $\pm 10\%$
48 V (± 4 V)	6.8 k Ω $\pm 10\%$

Make sure to use resistor pairs whose combined actual value is within 0.4 % of the specified value!

3. By inserting N 62 E or N 66 E AC power supplies between the mixer and microphones.
4. By using the B 18 battery power supply which is ideal for outdoor recording.

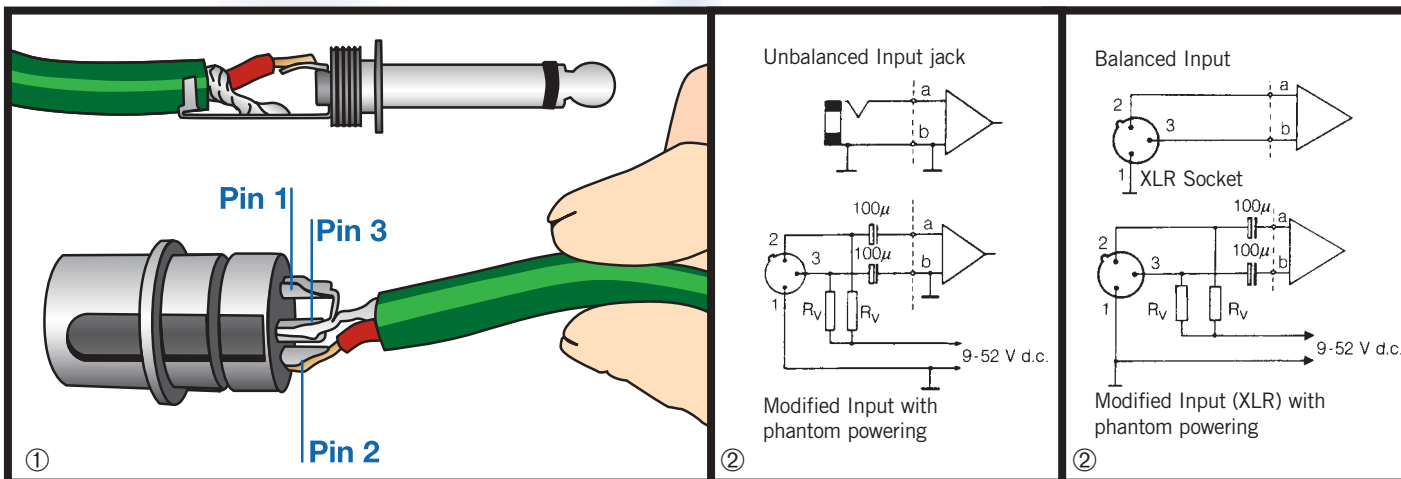

GLOSSARY

DEFINITIONS FROM A TO Z

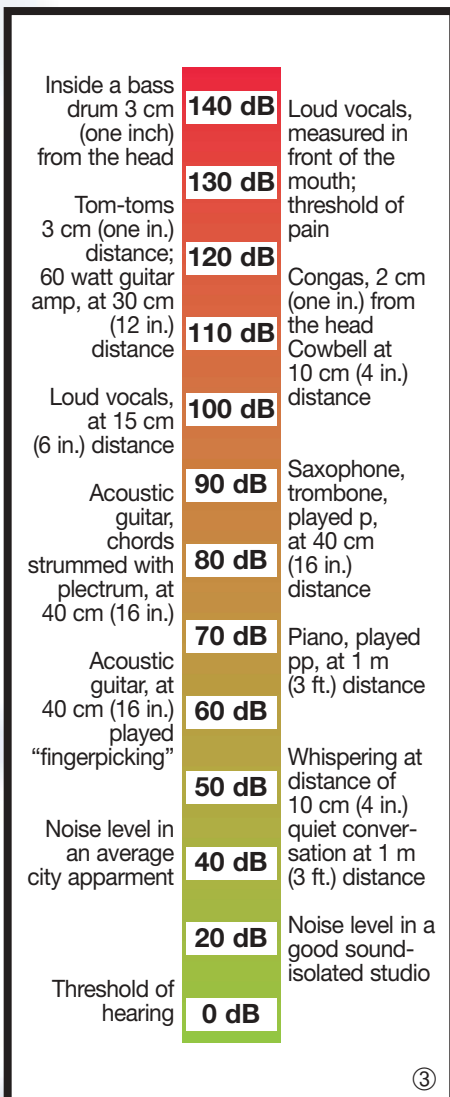

much less sound energy is absorbed by a directional microphone than an omnidirectional microphone.

Distortion

Dynamic microphones virtually never distort the signal. To be precise, their distortions at very high sound pressure levels (<130 dB) cannot be measured because loudspeakers are incapable of reproducing such levels distortion free. For this reason, we state no maximum SPL for dynamic microphones.

However condenser microphones with their built-in preamplifier may overload at high sound levels. When close miking (from a few inches) loud instruments such as drums or trumpets the microphone sensitivity should be reduced. With the C 535, simply use the preattenuation switch.

Directional Antenna

Antenna whose sensitivity is highest within a limited angle in front of the antenna. Directional antennas are used mainly where standard receiving antennas cannot be mounted within the range of the transmitters so the transmitter signals must be picked up from greater distances (e.g., in open-air arenas).

Diversity

Reception technique that ensures clear reception even in difficult environments. Diversity receivers use several antennas for the same carrier frequency and some models use several receiving sections, too.

Downtime

Period of time during which a system is inoperative.

Dropout

Momentary loss of signal due to squelch operation or interference.

Dynamic Microphone

A coil attached to a diaphragm is driven by the sound waves and vibrates between the poles of a magnet. This movement induces in the coil a voltage which corresponds to the sound pressure. Dynamic microphones handle high sound levels without overloading and are very rugged. They require no operating voltage. Dynamic microphones from AKG are designated by the letter "N" in front of the model number. Also known as "moving coil microphone".

Electret Condenser Microphone

Condenser microphone that needs no polarization voltage. Instead, a special metallized plastic "electret foil", in which a permanent electrical charge has been stored by application of heat and a high polarizing voltage, is used either for the diaphragm or the fixed electrode. The latter type is called "back plate electret microphone".

Electromagnetic Wave Spectrum

Range of frequencies of electromagnetic radiation.

Environment

Dynamic microphones will generally stand up to extreme environmental conditions such as temperatures from -25 °C to +70 °C and high humidity.

Condenser microphones, however, are susceptible to humidity and condensation. When an object is damp and colder than its environment, condensation water will form on its surface. Drops of condensation water inside the transducer or high-impedance preamplifier will cause crackling noises.

Storing condenser microphones:

1. Store the microphone in a dry and warm place. It should never be colder than its environment. If it has been transported in a cold car or van, allow it to warm up before use.
2. The supplied silica gel absorbs humidity. It will maintain this property as long as you keep it in the sealed package and may be regenerated in the oven if necessary.
3. Be sure to protect condenser microphones from rain when using them outdoors.

Equivalent Noise Level

Since condenser microphones incorporate a preamplifier, they introduce a low amount of self-noise which appears at the microphone output as an unwanted signal voltage. This noise voltage is measured using standard weighting filters and the result stated as the equivalent noise level in dB. An equivalent noise level of 20 dB, for instance, means that the self-noise of the microphone is as loud as a sound at 20 dB SPL (see dB SPL).

Noise level in quiet recording studio:

A low equivalent noise level means that the microphone's self-noise is low. The self-noise voltage is weighted either conforming to IEC 268-1 and DIN 45 405 using the filter according to CCIR 468-3 with the "quasi-peak" value being quoted, or in accordance with IEC 651 or DIN 45 412 using the A-weighting curve with the rms value being quoted. Studio engineers seem to prefer the CCIR weighting while A-weighting is still accepted as well.

ERP

Equivalent Radiated Power, a measure of a transmitter's RF output.

Far-Near Difference

The difference between the shortest and the longest distance between stage and antenna.

Crosstalk

The undesired coupling of signals from one channel to another channel.

dB SPL

Decibel Sound Pressure Level. A measure of the sound level referenced to 20 µPa (the sound pressure corresponding to the threshold of human hearing). A 6-dB increase in SPL would sound about twice as loud.

Deep Fade

Massive decline of received signal strength due to cancellation of the carrier in multipath transmission situations.

Directivity Factor

The directivity of a microphone can be expressed in terms of the amount of sound energy it absorbs out of a diffuse sound field. The directivity factor indicates how

GLOSSARY

DEFINITIONS FROM A TO Z

Feedback

When a microphone picks up amplified sound from a loudspeaker this signal will be reamplified, picked up again, etc., until the commonly known shrill howling (sometimes a lower midrange rumbling) sets in.

In small rooms, feedback is usually caused by reflections. In this case, acoustic treatment of the walls should help. On stages with correctly set up FOH speakers it is the monitor speakers that may cause feedback. A very good hypercardioid microphone (e.g. a D 3900) may sometimes provide a few extra dB's of gain-before-feedback. Place the monitors slightly off-axis (135°) where the microphone is least sensitive.

Frequency Management

Organization of frequency resources.

Frequency Modulation

A technology that alters (modulates) carrier frequencies to transmit information.

Frequency Range

The frequency range of a microphone is usually stated as the upper and lower frequency limits within which the microphone delivers a useful output signal.

Frequency Response

Microphones are not equally sensitive to all notes. The frequency response indicates the relationship between sensitivity and pitch. The 0-dB reference being the output voltage at 1 kHz, the frequency response is measured at constant sound pressure level, from about 20 Hz (lowest note) to 20 kHz (above the upper limit of human hearing).

Hum Sensitivity

Magnetic fields from amplifiers, long power cables, and lighting systems in particular may induce hum in microphones. A microphone's hum sensitivity gives an indication of how susceptible it is to this kind of interference. Values are 3 $\mu\text{V}/5 \mu\text{T}$ for dynamic microphones with hum suppression coil, 30 $\mu\text{V}/5 \mu\text{T}$ for dynamics with no suppression coil (D 90, D 95, D 190), and up to 10 $\mu\text{V}/5 \mu\text{T}$ for condenser microphones.

In practice, though, it is the microphone cables, most of all unbalanced ones, and mixer inputs, that are most likely to pick up hum.

Impedance

Frequency dependent AC resistance of a microphone. Always quoted at 1 kHz the actual impedance at other frequencies may differ slightly from this reference value. Also known as "source impedance".

Intercept Point

The Intercept Point (IP) provides a measure for an amplifier's resistance to intermo-

dulation distortion. IP 3, for example, is the reciprocal value of the third-order coefficient of an amplifier's nonlinear transmission polynomial.

Interference

Disturbance in transmission caused by extraneous signals.

Intermodulation

A nonlinear (multiplicative) combination of signals with different carrier frequencies that will produce completely new frequencies, called intermodulation products.

Limiter

Electronic circuit that prevents subsequent circuits being overloaded by excessive signal levels that would also cause distortion.

Line Microphone

The directivity factor of conventional unidirectional microphones is limited by the laws of physics. This can be overcome by installing a slotted tube in front of the diaphragm ("interference tube"). Off-axis sounds are canceled through interference, which results in an ultradirectional polar pattern.

Matching

Microphones should operate in an open circuit. This is the case if the input impedance of the preamplifier or mixer is at least 2 to 5 times as high as the microphone's rated impedance. The appropriate value is quoted in the specifications of each microphone as "recommended load impedance".

Maximum SPL

The highest sound pressure level (loudness) a microphone can handle without introducing more than a specified amount of "Total Harmonic Distortion" (1%), in other words, without distorting the signal. Usually measured at 1 kHz, except for the C 460 B ULS Series where it is quoted from 30 Hz to 20 kHz.

Mechanical Noise

See "Vibrational Noise".

Memory Effect

The loss of capacity which occurs in nickel-cadmium storage batteries if they are not completely discharged prior to recharging.

Modulation/demodulation

A sine-wave carrier starting at a time of minus infinity and ending at a time of plus infinity contains no information. However, any change in amplitude or frequency at any time (e.g., a pulse-like change) adds information to the carrier.

This process is called "modulation". The process by which a receiver detects and extracts this information from the carrier is

called "demodulation".

Multichannel System

A wireless microphone system that allows several radio microphones to be operated simultaneously in the same room.

Noise Burst

Brief disruption of the desired signal by noise from a transient interference source (e.g., ignition spark).

Noise skirt

An ideal carrier spectrum would be a line. As the carrier is modulated, the noise inherent in the switching signals makes the transients look ragged. This raggedness ultimately frequency-modulates the carrier with noise. Once that happens, the carrier spectrum is no longer a line but a noise spectrum that tapers off to either side of the wanted frequency, which is why this part of the spectrum is called a "noise skirt".

Phantom Power

to IEC 2681 5/DIN 45596

Condenser microphones require an operating voltage. It can be fed to the microphone either by a-b powering or phantom powering. In a-b powering, the operating voltage is fed to the balanced audio wires without using the shield. a-b powering is incompatible with dynamic microphones since the operating voltage would flow through the moving coil and destroy it.

In phantom powering, the negative terminal is connected to the cable shield and the positive terminal is split via decoupling resistors to the balanced audio wires. Since both audio wires carry the same potential, no current will flow through the coil of a dynamic microphone so there is no risk of destroying it even if the phantom power is accidentally left on.

When adding phantom power to a single ended (grounded) input or an input with no front-end transformer, either capacitors or an optional transformer need to be wired into the audio lines as shown below, to prevent leakage currents from entering the input stage.

Polarity

If you use more than one microphone for a recording, they should be of the same polarity. This means that if the diaphragms move in the same direction, the output voltages of all microphones should have the same polarity. If they don't there will be signal cancellation effects causing sound coloration – particularly in the bass range – as soon as you mix the microphone output signals together.

Polar Pattern

The "polar pattern" of a microphone indi-

GLOSSARY

DEFINITIONS FROM A TO Z

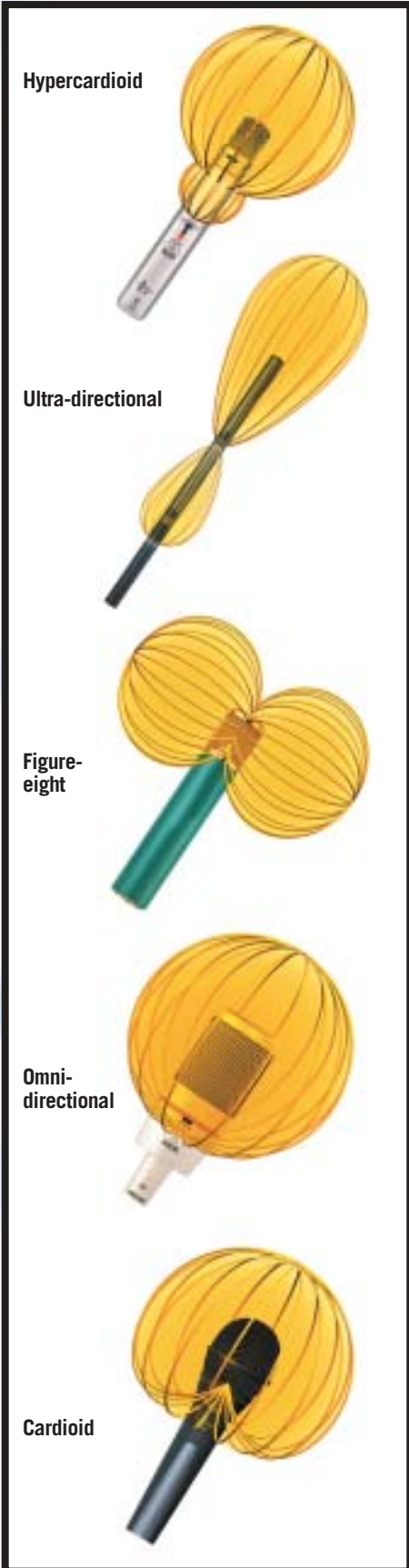

cates its sensitivity to sounds arriving from different directions. Omnidirectional microphones “hear” equally well in all directions while all others prefer sound from one (unidirectional) or two (bidirectional) directions. The polar diagram shows the three-dimensional “hearing performance” of a microphone as a single curve. It is sufficient to plot only one half of the curve (0° through 180°) since the other half (180° through 360°) is symmetrical. In this way, the directivity can be shown for several different frequencies (broken, dotted, solid lines).

Pop Noise

In order to avoid those unpopular pop noises on stage, remember the following:

- Talk across the microphone head.
- Interestingly, pop noises are worst about 2 in. from the mic. So move either closer or further away.
- Perhaps use an extra foam windscreen.

See “Accessories” section.

Pressure Gradient Microphone

If both the front and rear of a diaphragm are exposed to a sound field, then the force that vibrates the diaphragm results from the difference between the sound pressures in front and to the rear of the diaphragm (called the pressure gradient).

The magnitude of the driving force depends on the distance between the front and rear sound entries, the frequency, and the angle of incidence and is therefore a directional variable which can be utilized to design

directional microphones. Cardioid, figure eight, or hypercardioid polar patterns can be achieved by incorporating appropriate sound paths.

Pressure Microphone

If only one side (front) of a microphone diaphragm is exposed to a sound field and the other (rear) side sealed off by a soundproof case, the diaphragm will be vibrated by changes in sound pressure only. Sound pressure being a non-directional (scalar) variable, the microphone is equally sensitive in all directions. The resulting polar pattern is called omnidirectional 1.

Proximity Effect

In unidirectional microphones, as the working distance decreases, the output voltage rises more markedly at the low frequencies than throughout the rest of the frequency range. This is due to the fact that the diaphragm is vibrated by the pressure gradient between its front and rear surfaces and the pressure gradient is related to the curvature of the wave fronts.

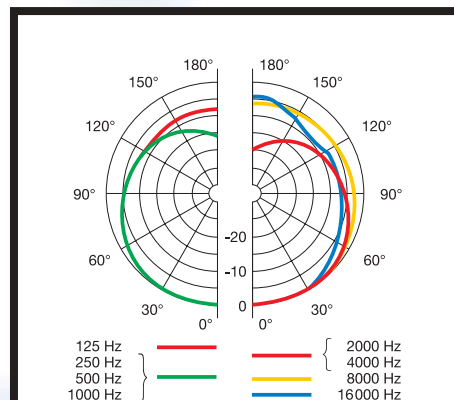

At 150° off-axis, the sensitivity is 17 dB down (referenced to 0°) at 125 Hz (solid line), and 10 dB down at 8 kHz (dashdotted line, right-hand half). 150° means 150° left, right, up, and down (see diagrams on the left).



GLOSSARY

DEFINITIONS FROM A TO Z

This effect, known as “proximity effect”, begins to become audible at a few hundred Hz and at extremely close working distances, the output level may be up to 15 dB higher at 50 Hz than at 1 kHz. This corresponds to about 6 times the normal output voltage.

Reflection

When a signal wave hits an obstacle, it will be reflected, i.e., bounce off the obstacle's surface at an angle equal to the angle of incidence.

Remote Antenna

Antenna that is connected by a special antenna cable to the antenna input socket on a receiver rather than directly to the antenna input socket.

Room Radius

In a room within which a sound is generated, e.g. by a loudspeaker, every point is characterized by its own unique ratio of direct sound and sound reflected from the walls.

The distance from the sound source at which the direct and reflected sound energies are equal is called the “room radius”. Outside the room radius the overall sound pressure level is constant throughout the room in the form of a “diffuse sound field”.

Sensitivity

A microphone's output voltage at any given sound pressure level. A more sensitive microphone will sound louder at the same gain setting (the feedback risk being proportionately higher). High sensitivity (condenser microphones) is needed to drive the mixer adequately when far miking quiet sound sources.

Sensitivity is commonly given in mV/Pa or dBV (referenced to 1 V/Pa) and measured at 1 kHz.

Here are some examples:

D 58	0.7 mV/Pa (-63 dBV)
D 190	1.6 mV/Pa (-56 dBV)
C 1000 S	6.0 mV/Pa (-44 dBV)
C 535	7.0 mV/Pa (-43 dBV)
C 451 EB comb	9.5 mV/Pa (-40.5 dBV)
C 460 Bcomb ULS/61	10.0 mV/Pa (-40 dBV)
C 562 BL	20.0 mV/Pa (-34 dBV)

Shadow loss

Signal loss which occurs in wireless transmission if an obstacle blocks the line-of-sight transmission path between transmitter and receiver.

Signal Loss

Signal loss in a cable may be due to ohmic resistance, dielectric leakage or radiation loss.

Signal-to-noise (S/N) Ratio

The S/N ratio is the difference between the reference sound pressure level of 94 dB (1 Pa sound pressure) and the equivalent noise level. Contrary to the equivalent noise level, a lower S/N ratio means higher noise and therefore a narrower dynamic range.

Squelch

Electronic circuit that switches the receiver off when the received signal is too weak so the associated extraneous noise and the self-noise resulting from the receiver being switched off will be inaudible. The squelch threshold is usually user adjustable within a preset range.

Tone coded squelch, tone code squelch, tone squelch

These terms denote a circuit that will open the audio path only when it detects a system-specific tone within the demodulated signal. This tone is higher than 20 kHz, the upper end of the range of human hearing, and is added to the audio signal by the transmitter.

Total Harmonic Distortion (T.H.D.)

A measure of the non-linear distortion of a signal (e.g. a sine wave) that occurs when a microphone or input is overloaded producing harmonics (overtones) at multiples of the fundamental frequency.

Transient

Temporary change in voltage or current occurring as a voltage or current source is switched on or off, e.g., a transistor controlled by a pulse signal.

Transient Response

The ability of a microphone to follow sudden sound events immediately. Transient response depends on diaphragm mass, transducer damping factor, etc.

Types of Microphones

Microphones utilize different electroacoustical principles to convert sound energy to electrical energy:

1. Carbon Microphone A microphone using a flexible diaphragm which moves in response to sound waves and applies a varying pressure to a container filled with carbon granules, causing the resistance of the microphone to vary correspondingly
2. Piezoelectric microphone A microphone in which deformation of a piezoelectric bar by the action of sound waves generates an output voltage between the faces of the bar. Also known as “crystal microphone”.

3. Magnetic microphone A microphone employing a diaphragm acted upon by sound waves and connected to an armature which varies the reluctance in a magnetic field surrounded by a coil. Applications include miniature microphones for hearing aids and guitar pickups.

4. Dynamic microphone A conductor (coil attached to diaphragm, ribbon) flexibly suspended in the field of a fixed magnet is vibrated by sound waves. This induces in the conductor an AC voltage that varies in step with the sound waves.

5. Electrostatic microphone A flexible diaphragm and a fixed electrode together form a two-plate air capacitor whose capacitance varies in step with the sound waves that vibrate the diaphragm. Also known as “capacitor microphone” or “condenser microphone”. In electret microphones one of the electrodes carries a permanent charge.

UHF

Ultra High Frequency

VHF

Very High Frequency

Vibrational Noise

In addition to air-borne sound, microphones also pick up mechanical noise such as impact, footfall, handling, or cable noise. Such unwanted noise can be reduced by special design features (transducer shock mount, compensation systems, bass cut)

Vocal Microphone

A microphone specifically designed for vocal use on stage. It incorporates a pop screen, a transducer shock mount to reduce handling and impact noise, and is particularly rugged so it will survive the occasional drop from the stand.

Many vocal microphones have an upper midrange (3 to 8 kHz) peak to make the voice cut through. In the studio, vocals are ideally recorded from 30 cm (1 ft.) or even farther, usually with condenser microphones.

Wavelength

The distance between two consecutive peaks (or troughs) of a sine wave.

INDEX

SELECTED KEYWORDS

Term	Page
Angle of sound incidence	13
Antenna placement	6f, 47, 60, 78
Automatic frequency search	32
Automatic frequency setup	32, 50, 54f, 62f, 68, 78
Bandwidth	9, 46, 50, 52, 58
Battery care	7, 56
Cable attenuation	47, 59f, 64
Cable length	48, 60
Carrier frequency	6f, 9f, 50, 52
Carrier signal	8f, 33, 43
Characteristic	31, 42, 44
Close-in miking	13
Deep fade	32, 34, 45, 47, 66
Dropout	7f, 30, 33, 45, 47, 49, 66
Dual antenna diversity	33
Electromagnetic waves/Electromagnetic wave spectrum	8, 30, 32
Electromog	30, 32, 34, 43, 45
Environment Scan	32, 50, 55, 63
ERP	43, 46
Far-near difference	32, 45
Feedback	23
Frequency band	8, 30f, 42, 46, 48
Frequency management	32, 34, 44ff, 55
Frequency modulation	9, 30
Handset	3
Identification	9, 34
Intercept	42
Interference	7, 8f, 30ff, 34
Intermodulation	7, 30ff, 34, 42ff, 49f, 54f
Level, sensitivity	14, 21, 26f, 42
Logic out/Output level	54f
Memory effect	56
Microphone cleaning and maintenance	13
Microphone position	13
Modulation	8
Multichannel system	46
Multipath reception	33
Network	30, 54, 58, 60, 62f
Pilot tone	50, 52, 53ff
Portable instruments	10f, 26, 80f
Powering	16, 34, 36f, 40, 54, 58, 60, 64, 68, 70
Preemphasis/Deemphasis	32
Quiet mode	53
Rack mounting	12
Receiver placement	7
Reflection	6f, 33, 47
Rehearsal function	32, 50, 55, 63, 68
Scattering	6
Selecting antennas/antenna cables	7, 47f, 50, 60
Selecting cables/Setting CLA	41, 43, 47ff, 58ff
Shadowing, shadow effect	6, 32f, 45, 47, 49
Signal transmission paths	7f
Signal/noise ratio	32f
Smart Battery Management System (SBMS)	50, 56f
Squelch	17, 30, 32, 34, 42
Troubleshooting	34
True diversity	33, 36, 50, 54, 58
Wavelength	8, 30

APPENDIX

NOTES

APPENDIX

NOTES

APPENDIX

NOTES

APPENDIX

NOTES

APPENDIX

NOTES

AKG ACOUSTICS

www.akg.com

Microphones · Headphones · Wireless Microphones · Wireless Headphones · Headsets · Electroacoustical Components

AKG Acoustics GmbH

Lemböckgasse 21–25, P.O.B. 158, A-1230 Vienna/AUSTRIA, Tel: (+43 1) 86 654-0*, Fax: (+43 1) 86 654-7516, www.akg.com, e-mail: sales@akg.com, Hotline: (+43 676) 83200 888, hotline@akg.com

■ A Harman International Company

AKG Acoustics GmbH

Bodenseestraße 228, D-81243 München/GERMANY, Tel: (+49 89) 87 16-0, Fax: (+49 89) 87 16-200, www.akg.com/de, e-mail: infode@akg.com, Hotline: (+49 89) 87 16-22 50, hotlinede@akg.com

AKG ACOUSTICS, U.S.

914 Airpark Center Drive, Nashville, TN 37217, U.S.A., Tel: (+1 615) 620-3800, Fax: (+1 615) 620-3875, www.akgusa.com, e-mail: akgusa@harman.com

For other products and distributors worldwide see our website: www.akg.com

Specifications subject to change without notice.

Printed in Austria.

03/04/PROA 1487

