

Soundweb™

London

## NETWORKED PROGRAMMABLE DSP SYSTEMS



## EVOLUTION



○ BSS Audio's Soundweb sent ripples around the industry when it was introduced. Until then, no one offered such an integrated programmable DSP system with control and audio networking on a single Cat 5 cable. No one offered the breadth and simplicity of control and interfacing delivered by BSS Audio.

Since then, the benefits of this level of technology have been recognised and emulated around the world, but there are key areas where the original Soundweb philosophy still stands proud of the rest:

- The free-design programmable DSP system allows the creation of virtually any audio system design, and places no restrictions on signal path, sub-mixing or object location
- It offers the ability to change how your audio system behaves according to the type of event you are holding, just with the recall of a preset
- It allows easy and quick addition of more signal processing within the system without increasing the hardware budget
- It enables any specification changes during or post the design phase to be implemented easily
- It means that your clients can be given the level of control their users need, without providing overly-complex interfaces.



This philosophy extends into the new Soundweb™ London range, where the benefits of working closely with literally thousands of clients have enabled BSS Audio to enhance the power and flexibility over the Soundweb system to unprecedented levels.

In developing the Soundweb London range, BSS Audio has adhered to the key requisites that made Soundweb so phenomenally successful and still managed to make advancements. Soundweb London offers:

- **Pristine audio quality, with advanced A/D and D/A conversion, together with 96kHz-capable audio processing and networking**
- **Simple installation using low-cost Cat 5 cable**
- **Simple, easy to learn drag-and-drop system design, now even more powerful with easy CobraNet™ bundle assignment, signal path navigation and intelligent DSP objects**
- **Ethernet based control over Cat 5 cable, with network audio via CobraNet™ with dual-redundancy capability**
- **A variety of control options to offer clients simple or sophisticated control interfaces**
- **Distributed processing, networking and DSP that allows you to put hardware wherever it's needed**
- **Easy expansion or reconfiguration of system hardware in the field**

With years of experience to count on, Soundweb London represents a wise choice for those investing in programmable DSP technology.

## THE SYSTEM APPROACH



No one has before offered, or been in the position to offer, the integrated system approach that Soundweb London offers.

BSS Audio's Soundweb London system provides the backbone for a completely unified system solution using microphones, consoles, amplifiers and loudspeakers from sister Harman Pro companies AKG, Soundcraft, Crown Audio and JBL, along with the integration of dbx and BSS signal processing devices.

Programming the processing system has never been easier or more powerful.

Now, by adding integrated monitoring of Crown Audio PIP-LITE, USP3 and USP3/CN Programmable Input Processor ('PIP') modules, as used on the CTs series of amplifiers, configuration of BSS FDS-334T and FDS-336T MINIDRIVE processors and the industry standard FDS-366T OMNIDRIVE system, one control application can additionally watch amplifier performance, speaker conditions and report errors back to the operator.

Above all, the Soundweb London system makes life easy...

## EASY TO DESIGN

All your audio system can be designed offline, even while travelling. London Architect, the new generation BSS software platform, enables advanced system design, catering for dedicated zones, design of freely configurable signal paths and default parameter configuration for processing objects such as gains, EQ etc. The list of processing objects is extensive, and DSP algorithms are proudly modelled on classic BSS analogue processing products.

## EASY TO INSTALL

Each Soundweb London device is totally self-contained, so the audio and control network means that devices can be installed locally to their amplifier racks rather than in one centralised location. Category 5 cable is used to interconnect system devices and Ethernet hardware, with network hops of 300 feet (100 metres) possible.

The most effective system configuration can be achieved with just two Cat 5 cables to handle all control, monitoring and audio networking. By adding a third Cat 5 cable, CobraNet™ audio network redundancy can be achieved.

To minimise the amount of Ethernet and networking knowledge required to configure such a system, all Soundweb London devices auto-negotiate their IP addresses regardless of any other devices present on the network. For those who wish to take more control of the network, these IP addresses can easily be overridden.

## EASY TO OPERATE

From untrained operators and staff to fully-trained engineers, a Soundweb London system can be left with whatever degree of control is required, from simple wall-mounted volume and source controls for waiters and bar staff, to far more sophisticated configurable control using the BLU-10 controller. The BLU-10 features a touch screen LCD interface with customisable menu screens and a rotary encoder that can control virtually any system parameter that the system designer requires.

## EASY TO INTEGRATE

Soundweb London also has comprehensive RS-232 serial interfacing for simple message-based control from external control systems. Additionally, parameters of Soundweb London can be addressed directly over Ethernet.

The 12 integral control input ports on the rear of each Soundweb London device enable control from analogue switches and faders, while the six integral logic output ports enable Soundweb London to control external equipment.

## INDUSTRY-STANDARD AUDIO NETWORKING WITH COBRANET™

Soundweb London incorporates the now industry-standard CobraNet™ audio network from Peak Audio, a division of Cirrus Logic, which allows the use of off-the-shelf Ethernet components for building larger systems capable of transferring 32 x 32 channels across a single Cat 5 cable from device to device, many more than were possible with the original Soundweb network. This allows each Soundweb London device to create matrix sizes of 40 x 40 channels.

| Name         | Bundle | Rate   | Tx   | Rx               |
|--------------|--------|--------|------|------------------|
| None         | 0      | -      |      |                  |
| Main Evac    | 1      | 48 KHz | U1A  | U3A, U4A, U1...  |
| Evac Backup  | 2      | 48 KHz | U2A  | U3B, U4B, U10... |
| Page Zone #1 | 300    | 48 KHz | U3A  | U1A              |
| Page Zone #2 | 301    | 48 KHz | U4A  | U1B              |
| Page Zone #3 | 303    | 48 KHz | U10A | U1C              |
| Page Zone #4 | 304    | 48 KHz | U11A | U1D              |
| Int Comms #1 | 1000   | 96 KHz | U14A | U12C             |
| Int Comms #2 | 1001   | 96 KHz | U12A | U14C             |

Soundweb London has also been designed to take full advantage of the latest CobraNet™ features such as low latency settings (as low as 1.33 msec) and 96kHz operation.

BSS has also worked closely with Peak Audio to provide probably the simplest available programming interface to CobraNet™, as well as developing an auto-IP addressing mode that automatically assigns IP addresses to hardware, regardless of existing addresses on the network. Ethernet and CobraNet™ systems have never been this easy to set up.

While some systems rely on multi-way hardware switches for CobraNet™ bundle assignment, Soundweb London can be programmed from directly within the core design software, making the process easier before, at, and after installation. Not only can bundles be configured in this way, but also settings can be stored for later recall, and adjusted in real time.

It can be easy to get lost in the audio interconnection while tracking these bundle assignments, but BSS Audio has taken care of that. CobraNet™ bundles are also referred to within the design software by their user-definable names preventing the need to remember a list of bundle numbers when moving from box to box during the design stage. Additionally, when a bundle has been assigned and connected between two devices, an arrow appears within the bundle icon in the design window. Clicking on this arrow will immediately take you to the corresponding CobraNet™ bundle in the other unit.

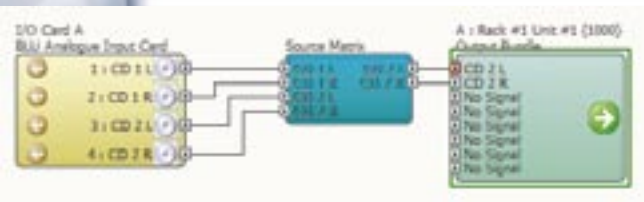

## NETWORK DISTANCES

The maximum distance between any hardware device and Ethernet switch is 300 feet (100 metres). To extend this distance, regular Ethernet-to-fibre systems may be used. There are design considerations to be taken into account in any Ethernet system, and BSS Audio is happy to assist wherever possible.

## NETWORK REDUNDANCY

The CobraNet™ compatible devices within the Soundweb London system are fitted with a Peak Audio CobraNet™ CM-1 module. The module itself offers a Primary and a Secondary CobraNet™ port. Under normal operation the Primary port only receives and transmits audio data from and to the network. Should the Primary port or connection fail in some way, the CM-1 module automatically switches to receive and transmit from and to the Secondary port.



## — LONDON ARCHITECT — THE ORIGINAL 'DESIGNER' GETS SUPER POWER

Soundweb Designer took system design and control to an unprecedented level. Now **London Architect** brings even more power to your design creativity, and is the real advantage over similar DSP systems.

**Total flexibility of signal path flow and connectivity, a massive range of processing objects modelled on classic BSS processors, and the freedom to design the system how you want it to be.**

The core system design software for the London system uses the familiar drag-and-drop design interface that Soundweb users will know well, but has been dramatically enhanced to provide a more powerful, flexible and user-oriented interface.

BSS Audio has spent a great deal of time with key industry users to ensure that the new programming interface will work for them and you. Users familiar with Soundweb Designer will immediately understand and appreciate the extensive upgrades to the design suite.

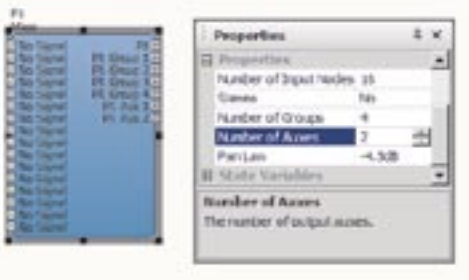
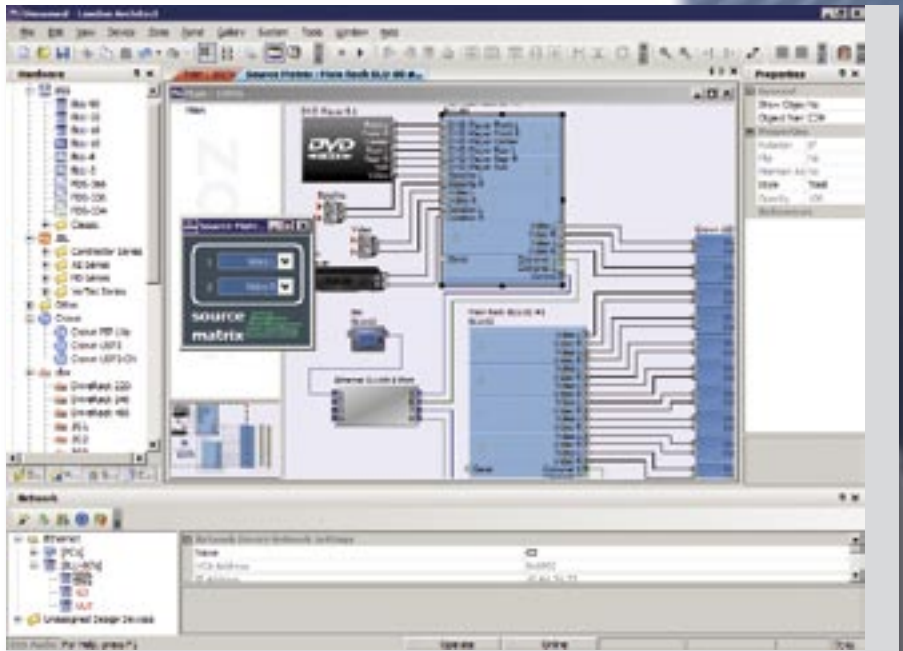

Features of the new software include dockable tool menus, creation of zones, layout scrolling and zooming and mini-map windows, while innovative processing objects such as expandable mixers make design and object selection easier than ever before.

New control panels with a vast gallery of controls, highly informative docking windows, copying control values across objects, — just a few of the ways in which we've made London Architect so powerful. Information at microscopic levels illustrates exactly what's going on.

## — CUSTOM CONTROL PANELS

Creating custom control panels, one of the advantages inherited from Soundweb Designer, has been made even easier, with simple mouse clicks to create control panel pages and add 'unbound' elements such as meters and faders that can then be tied to distinct processing objects. Not forgotten is the 'traditional' method of creating panels by dragging controls directly onto these custom panels. Sub-pages can also be nested within panels, increasing their versatility, offering neater layout of controls and taking the concept to an unprecedented level.

## — PROVEN DSP PROCESSING OBJECTS

All the familiar Soundweb DSP objects are included; many modelled on the classic and respected BSS Audio analogue processors. The platform has been designed to enable future software releases to include new leading edge DSP functions.

## — ADDING OTHER EQUIPMENT TO THE CONTROL CENTRE

For the first time other devices can be included in the system solution and configured and operated from the same centralised PC suite, including the FDS-366T OMNIDRIVE Compact Plus and FDS-334T and FDS-336T MINIDRIVE processors. The large system example on the central pages demonstrates the power of London Architect.

Some of the new and more radical features of London Architect are described below. Users familiar with Soundweb Designer will immediately appreciate these powerful facilities.

### — SIGNAL PATH NAMING

To allow the signal paths to be traced with the greatest of ease — just name the source object, and wherever the signal is routed, the name follows it through whether within the same device or across the network from device to device. This feature can best be seen in action within the software. London Architect is a free download from <http://www.soundweb-london.com>.

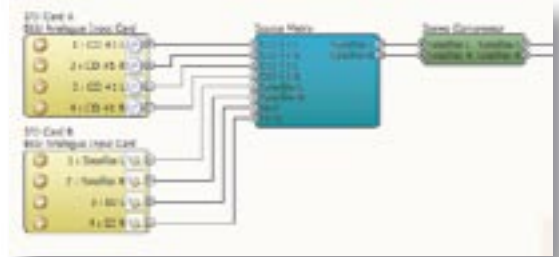

### — ZONE CREATION

Zones can be created within the system views to enable sensible layout of larger systems, by representing individual rack rooms, for example. This allows highly convenient groupings of hardware devices, and also reduces screen clutter in the main system design window. Zone navigation is made quick and easy with the navigation tree adjacent to the system design view.

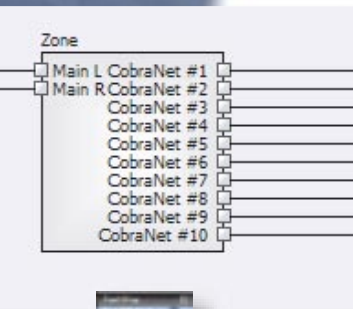

Sub-zones can also be created within zones, to assist further with creating discrete hardware processing areas.

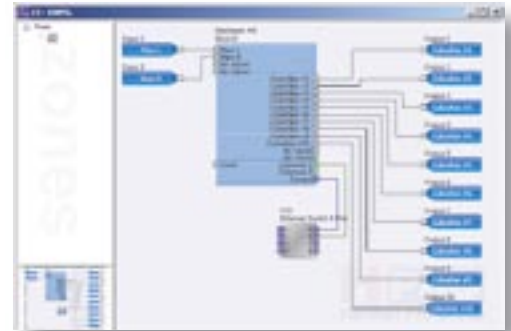

### — AUTO BACK UP IN THE EVENT OF FAILURE

To prevent the loss of a working file in the event that the PC loses power or crashes, London Architect continually writes the state of the file to a database so that it can automatically recover that state when the application is rebooted.

### — DESIGN FILE UPLOAD/DOWNLOAD

The entire original London Architect design file can be saved from the application into flash memory within the Soundweb London physical devices on the network for retrieval at a later date if you do not have access to the original design, an occurrence often encountered in the field.

### — RECALL

Parameter Recall, Device Recall and Venue Recall are the methods by which parts or all of the system from individual parameters to multiple device configurations can be restored. Each device is able to store several DSP and wiring configurations for later recall.

Parameter Recall enables values of multiple parameters from multiple devices within a system, such as CobraNet™ bundle assignments, EQ settings, levels and gains, etc. to be restored either from the software application, from an external serial or Ethernet controller or via the analogue GPI control ports on the rear of each rackmount device.

### — CONTROL PORTS AND OPTIONS

Each Soundweb London device has 12 Control port Inputs and 6 Control port outputs.

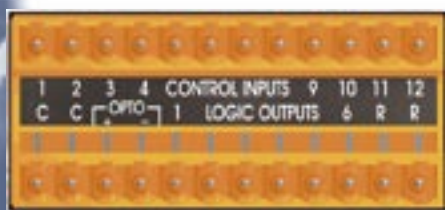

## WAVE FILES FOR MESSAGING

You can assign a .wav file to an object, so that if a channel is muted or unmuted remotely, for example, it triggers playback of the wave file through the PC, useful for alerting a centralised operator that an event has occurred. It could even warn of problems with outputs in remote areas.

## MULTIPLE UNDO FACILITIES

Not content with just providing 256 levels of design undo a drop-down menu also lists the last 20 design history tasks to which the design file can be restored instantly.

## INTEGRATION WITH AMPLIFIER AND LOAD MONITORING

London Architect allows simultaneous and integrated monitoring of Crown Audio's PIP-LITE, USP3 and USP3/CN PIP modules, which can be installed in the Crown CTs series of amplifiers, providing probably the most powerful CobraNet-based integrated processing, amplification and monitoring system available.

For existing Crown users, the interface adopted will be instantly recognisable as the control panels have been closely copied from the existing layout in Crown's own IQwic™ software in order to keep transition time to a minimum. IQwic™ and London Architect can co-exist happily on the same network and the PIP modules can be seen and controlled by both applications simultaneously. Indeed, more complex PIP signal paths and DSP configurations can continue to be designed within IQwic™ before switching seamlessly to monitoring the devices with London Architect.

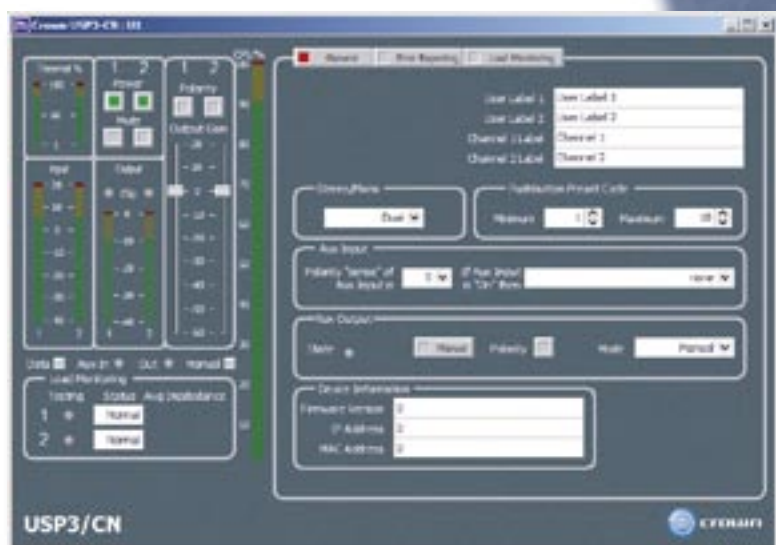

| East Wing      |    |
|----------------|----|
| East BLU-80#1  | 80 |
| East BLU-32#2  | 32 |
| East BLU-32#1  | 32 |
| South Wing     |    |
| South BLU-80#1 | 80 |
| South BLU-32#2 | 32 |
| South BLU-32#1 | 32 |
| West Wing      |    |
| West BLU-32#2  | 32 |
| West BLU-32#3  | 32 |
| West BLU-32#1  | 32 |

**NO OTHER SYSTEM AVAILABLE TODAY OFFERS SO MUCH POWER AND INFORMATION FOR THE SYSTEM DESIGNER AND OPERATOR.**



EXAMPLE OF HOW AN INTEGRATED SYSTEM CAN BE CONSTRUCTED IN LONDON ARCHITECT

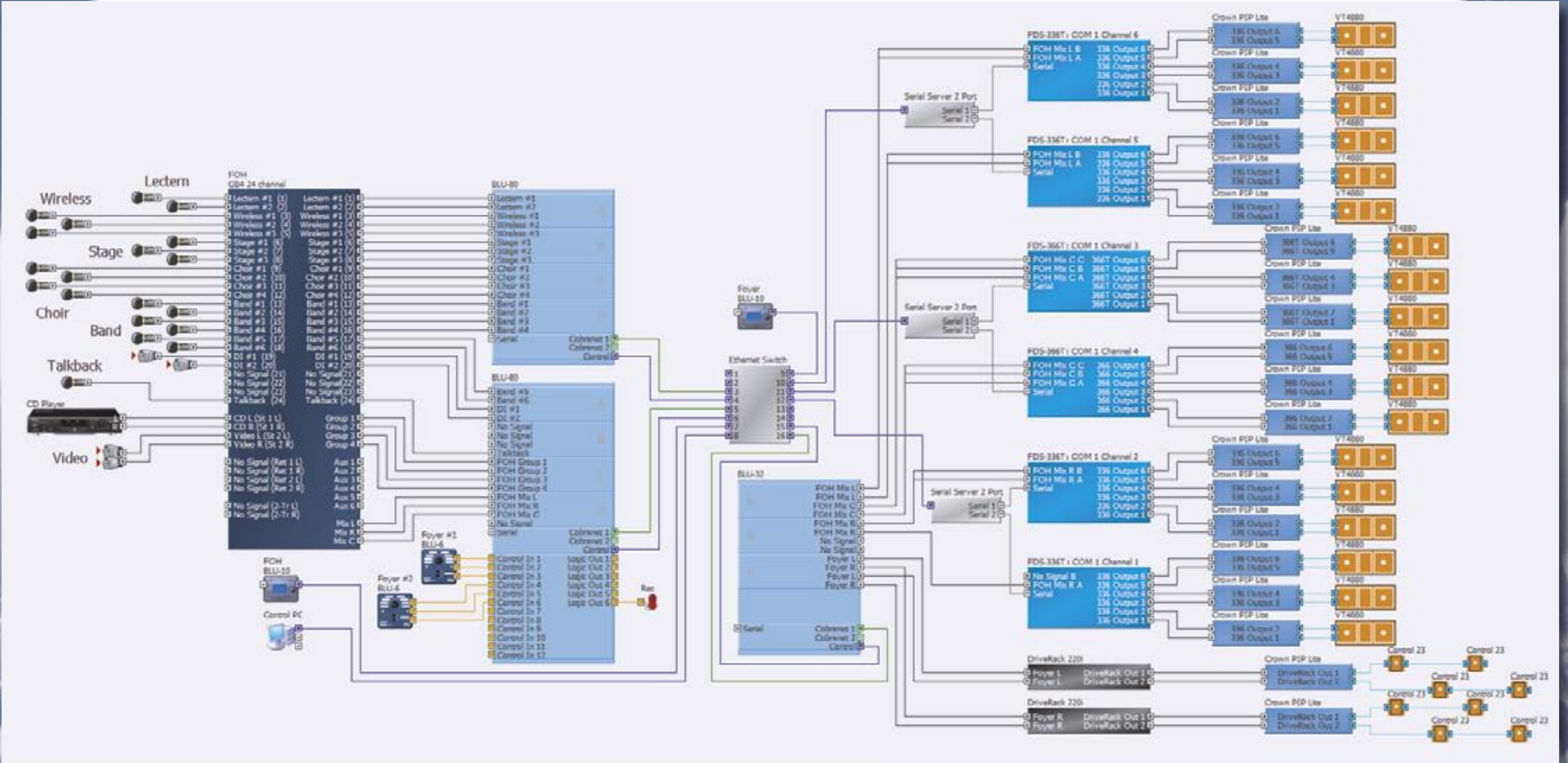



BSS Audio has demonstrated time and again that the distributed intelligence hardware solution offers the most flexibility in hardware location and installation, and Soundweb London continues with this philosophy.

Each device in the range includes LED indication of input or output signal presence, and a blue LCD screen to provide unit ID and IP address. Illuminated locate switches on the front and rear panels allow quick and easy identification of each device in three places simultaneously — within the London Architect software and from the front and back of the rack.

Each BLU device also provides 12 control inputs and 6 control outputs for interfacing with GPI controls such as faders, pots, switches and LEDs. These can be used with the BLU-3 and BLU-6 controllers, or custom controllers may be designed and produced. The logic outputs can be used to drive proprietary interfaces to trigger infrared commands to control DVD players for example, or power relays to turn other equipment on or off.

**BLU-80 SIGNAL PROCESSOR**  
Networked CobraNet™ Processor



The mainstay of the Soundweb London processing system is the BLU-80. Whether your system requires more inputs than outputs, or more outputs than inputs, Soundweb London can be configured for the optimum system at the optimum cost for the client.

- Up to 16 Mic/line inputs or line outputs in a single frame, configurable in 4 banks of 4 input or output channels
- Peak Audio CobraNet™ CM-1 module offering up to 32 x 32 network channels
- Massive DSP power in each frame
- Integral multi-voltage switched mode PSU for lightweight and universal AC mains operation.
- 18 Analogue control ports for GPI hardware interfacing using faders, pots, switches etc.
- Front USB port for PC control and rear RS-232 port for third party serial control
- Ethernet port for control network

|           |      |            |
|-----------|------|------------|
| 16 Inputs | ———— | 0 Outputs  |
| 12 Inputs | ———— | 4 Outputs  |
| 8 Inputs  | ———— | 8 Outputs  |
| 4 Inputs  | ———— | 12 Outputs |
| 0 Inputs  | ———— | 16 Outputs |

The BLU-80 can accept 4 input or output cards, each card being either 4 inputs or 4 outputs. This means that a BLU-80 can be easily configured at base or in the field to provide these I/O configurations.

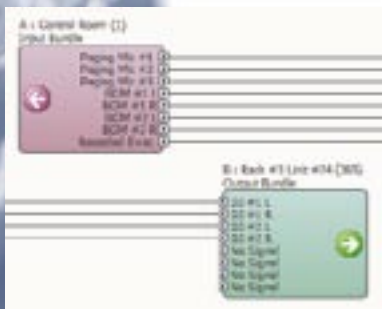

Units may also be part fitted for even more cost-effective system design. The LED indication on the front panel provides quickly understandable signal states, whether they apply to input or output cards. Field upgrades are therefore very simple and easy to implement. When viewed from the rear, an LED next to each card indicates whether an input or output card is fitted, so making onsite card identification very easy.

As with Soundweb, all analogue connections are balanced, on Phoenix/Combicon connectors

The Peak Audio CM-1 module provides CobraNet™ audio networking for the BLU-80. This card allows up to 32 inputs and 32 outputs of digital audio at 48kHz and up to 16 inputs and 16 outputs at 96kHz sampling rates to reach each BLU-80 or BLU-32 frame.

**BLU-32 SIGNAL PROCESSOR**  
 Networked CobraNet™ I/O Expander



Where simple I/O expansion at lower cost is required, look to the BLU-32. This device offers identical I/O configurability to the BLU-80, but features no DSP, and therefore simply allows inputs and outputs to be routed onto and from the audio network. Programmed within London Architect, the BLU-32 makes it easy to expand I/O simply and at low cost.

Systems can now be built to cater for differing ratios of inputs and outputs, without incurring the cost of expensive DSP boxes simply to add outputs leaving inputs unused.

**BLU-16 SIGNAL PROCESSOR**  
 Standalone Processor



The BLU-16 has all the I/O flexibility and DSP power of the BLU-80, but is a standalone device with no audio networking capability. This makes the BLU-16 a more cost-effective solution for the smaller install where a 16-input/output count is sufficient. Theme bars, restaurants, gymnasiums are typical examples of solutions which will easily be satisfied by the BLU-16.

All the control options which apply to the BLU-80 also apply to the BLU-16, including the ability to interface with the BLU-10 programmable controller. In fact, using a network crossover cable between the BLU-16 and BLU-10 avoids any need for additional Ethernet hardware.

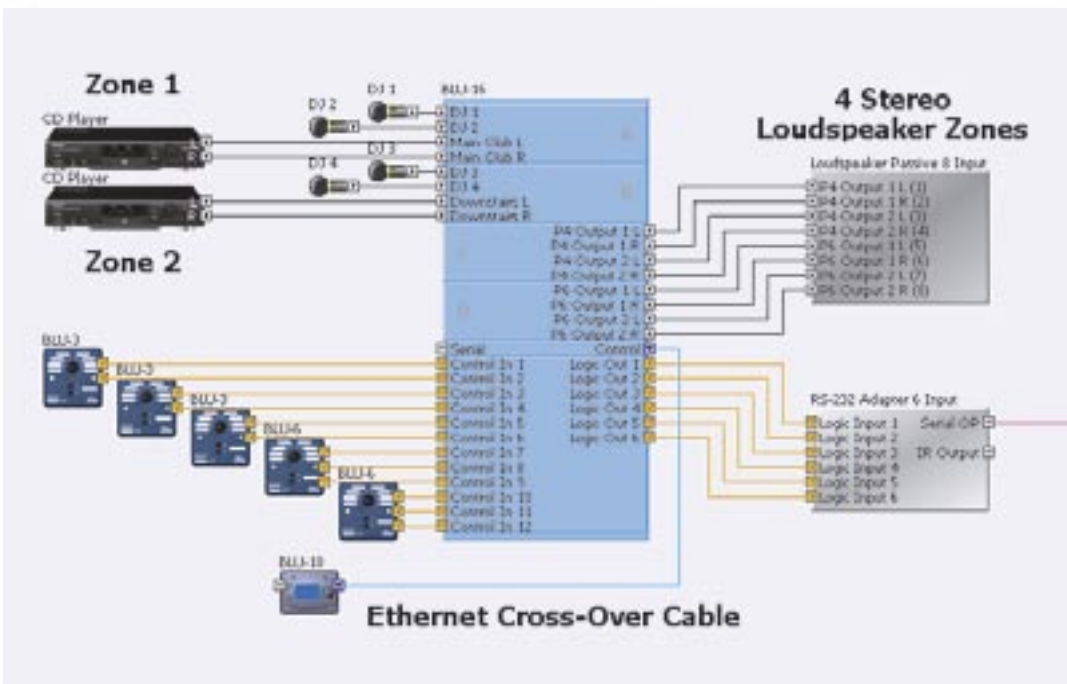

## — BLU-10 PROGRAMMABLE CONTROLLER

The original SW9010 Programmable Controller set new standards in control interfacing to DSP systems, and has yet to be bettered as a simple yet powerful interface.

The Soundweb London equivalent, the BLU-10, builds on that power and reputation by adding touch-screen control to make a more attractive and potentially cost-saving control solution. It is possible that a BLU-10 could replace a more-expensive proprietary touch screen solution where simpler control interfacing is required.



As with the SW9010, up to 100 control 'pages' of virtually any Soundweb London DSP parameter can be constructed, with the ability to create 'folders' for nested menus. Access to specific pages can be restricted with the use of password protection, so that only engineers or key employees can adjust critical system parameters.

Each page can hold up to eight different functions and with navigation being carried out entirely by a page list, all of these functions can be assigned to real parameters rather than functioning as page transitions.

## — PROGRAMMING THE BLU-10

Soundweb users will be familiar with the simple drag-and-drop programming interface, and the BLU-10 interface is very similar. Once the menu pages have been created, operation of the pages can be simulated using the special simulation mode, which emulates how the controller will work when in use. This allows menu structures to be checked before the system goes live.

The BLU-10 connects into a Soundweb London network via its Ethernet port, either directly into the rear of a rackmount device such as the BLU-16 with a Cat 5 crossover cable, or with a standard Cat 5 cable into an Ethernet switch. The unit is powered either using the terminals on the rear, accepting a range of 12V - 48V DC or with IEEE802.3af Power Over Ethernet (POE).

## — MECHANICAL INSTALLATION

The BLU-10 mounts in a standard US 3-gang wallbox (available from BSS Audio) using the screws provided with the unit.

## BLU-3, BLU-6 WALL-MOUNT CONTROLLERS



The BLU-3 and BLU-6 wall panels are simple controllers which allow the designer to provide a rotary fader control and source selection or preset recall in a simple wall-mounted panel.

These controllers connect to the control ports on the rear of any BLU-16, BLU-32 or BLU-80 device.

The BLU-3 offers a rotary fader and a five-way switch. The switch could select system presets (configurations specific to times of the day, for example) while the rotary control could be assigned to act as a zone volume control.

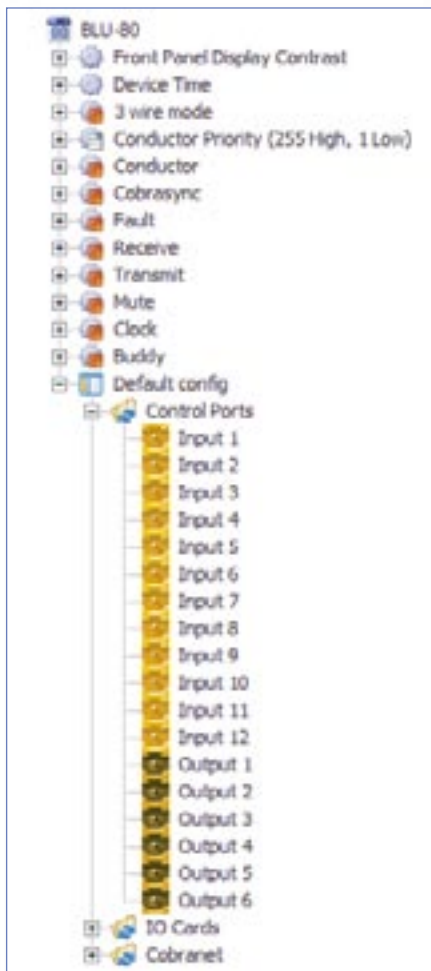

The BLU-6 offers an eight-way switch, but instead of a rotary volume control has a pair of spin or up-down buttons, enabling the same level parameter to be mapped onto other controllers preventing a jump in audio level when the control is adjusted

The switches on both units have blank areas for marking the switch functions, either directly onto the white area, or on self-adhesive labels.

# KEY FUNCTIONS



## CARD POSITION A

Indicators associated with the I/O card fitted in position A (see also B, C and D)

### I/O INDICATOR

Indicates whether the I/O card fitted in the relevant slot is an Input or Output card

### CLIP

Indicates clipping in the analogue domain for each channel of the fitted Input or Output card. the LED will illuminate at +18.5dB

### SIGNAL

The signal LED will illuminate for each channel of a fitted Input or Output card when the signal reaches or exceeds the signal threshold of -20dB

### SYNC/48V

Illuminates to indicate +48V phantom power has been activated for the relevant channel of a fitted input card

## CONDUCTOR

The master clock device of a CobraNet™ system is referred to as the Conductor – the CM-1 modules in the system auto-negotiate which device will transmit the Conductor beat packet. The LED illuminates to indicate which device is acting as the Conductor.

### NETWORK LINK

The Network Link indicates the presence of Cat5 Ethernet cables. If no cables are connected, the LED is unlit; the LED flashes is either a control or CobraNet™ cable is fitted and remains illuminated if both cables are connected.

### DATA ACTIVITY

The Data Activity LED will flash to indicate that the device is communicating with another control device, either on the network or via the USB, serial or control ports.

### USB

Besides connecting to the system over the network, a USB 1.1 interface is provided on the front of the device for communication with a PC running London Architect. All devices on the network can be seen by a PC connected in this manner.

## LCD DISPLAY

Indicates the name/ ID and IP Address of the unit.

## LOCATE

Pressing the Locate switch on the front of the unit will illuminate the Locate switch on the rear and identify the device within London Architect. Similarly the switch will illuminate if the device is selected from within London Architect or from the Locate switch on the rear.

### CONTRAST (Hold)

Pressing and holding the Locate switch will cycle the LCD through its contrast range.

## AC MAINS

AC Mains input to the universal switched-mode power supply, operates over a wide range of AC input voltages from 85V to 270V, 50/60Hz.

## COBRANET CONNECTORS Primary/Secondary

The CobraNet™ compatible devices within the Soundweb™ London system are fitted with a Peak Audio Cobranet™ CM-1 module. The module itself offers a Primary and a Secondary Cobranet™ port. Under normal operation the Primary port only receives audio data from and transmits audio data to the network. Should the Primary port or connection fail, the CM-1 module automatically switches to receive from and transmit with the Secondary port.

## BUDDYLINK/48K

The CobraNet™ BuddyLink In/Out BNC connectors allow two similarly configured Soundweb London devices to be linked together and operate as a redundant pair with fail-over capability. A 48kHz system clock is generated at the BuddyLink Out port.

## CONTROL INPUTS

Twelve Control Inputs may be used to connect analogue switches, faders, rotary controls etc to permit simple control of Soundweb London parameters.



## LOCATE

Pressing the Locate switch on the rear of the unit will illuminate the Locate switch on the front and identify the device within London Architect. Similarly the switch will illuminate if the device is selected from within London Architect or from the Locate switch on the front panel.

## RS-232

Serial port for connection of external control equipment.

## ETHERNET

The main connection for the proprietary system control network, and for third party Ethernet control.

## LOGIC OUTPUTS

Six Logic Output connections are provided to allow LED tallies or facilitate remote control of external equipment from London Architect and Soundweb London devices.

## I/O CARD POSITIONS A, B, C and D

These connectors provide the balanced connections for the I/O card fitted in the four card slots in a Soundweb London device. A green LED next to the slot assignment letter A, B, C or D indicates that an Input card is fitted and an amber LED when an output card is fitted. The analogue connections are balanced, on Phoenix/Combicon connectors.

WHILE THE SOUNDWEB LONDON HARDWARE IS STATE-OF-THE-ART, THE REAL POWER OF THE SYSTEM COMES FROM ITS PROGRAMMING WITHIN LONDON ARCHITECT.

THE FUTURE IS ABOUT SYSTEM INTEGRATION.



# Soundweb™

# London

## TECHNICAL SPECIFICATIONS

### GENERAL BLU-16, BLU-32 and BLU-80 TECHNICAL SPECIFICATIONS

#### INPUTS

|                           |   |
|---------------------------|---|
|                           | up to 16 Analogue; electronically balanced on Phoenix/Combicon removable screw connectors.      |
| Mic/Line Inputs:          | Nominal gain 0dB, electronically switchable up to +48dB, in +6dB steps, input impedance 3.5kOhm |
| Maximum input level:      | +20dBu with 0dB input gain, (+8dBu with 12dB gain)  |
| CMRR:                     | >75dB at 1KHz   |
| Equiv. Input Noise (EIN): | <-128dBu typ with 150 Ohms source   |
| Phantom power:            | 48V nominal, selectable per input   |

#### OUTPUTS

|                       |  |
|-----------------------|--|
|                       | up to 16 Analogue; electronically balanced on Phoenix/Combicon removable screw connectors. |
| Maximum Output Level: | +19dBu   |
| Frequency Response:   | 15Hz to 20KHz (+0.5dB/-1dB)  |
| THD:                  | <0.01% (20Hz to 20KHz, +10dBu output)  |
| Dynamic Range:        | 108dB typ. (22Hz to 22KHz unweighted)  |
| Crosstalk:            | <-75dB   |

#### CONTROL PORTS

|                          |  |
|--------------------------|--|
|                          | 12 inputs and 6 outputs                            |
| Control Input Voltage:   | 0 to 4.5v  |
| Control Input Impedance: | 4.7kOhms to +5V (2-wire mode) >1MOhm (3-wire mode) |
| Logic Output Voltage:    | 0 or +5V unloaded                                  |
| Logic Output Impedance:  | 440 Ohm  |
| Logic Output Current:    | 10mA source, 60mA sink                             |

#### WATCHDOG OUTPUT

|                       |   |
|-----------------------|---|
|                       | Phoenix/Combicon connector for failsafe control |
| Opto Output current:  | 14mA maximum                                    |
| Withstanding voltage: | 80V maximum (Off)                               |
| Series Impedance:     | 220 Ohms (isolated)                             |

#### CONTROL NETWORK

|                       |  |
|-----------------------|--|
| Connectors:           | RJ45 Ethernet connector (BLU-10, BLU-16, BLU-32, BLU-80),<br>2 x CobraNet RJ45 Ethernet connector (BLU-80, BLU-32) |
| Maximum cable length: | 100m/300ft between device and Ethernet switch  |

#### CobraNet™ AUDIO NETWORK (BLU-80, BLU-32 only)

|                       |   |
|-----------------------|---|
| Connectors:           | 2 x RJ45 connectors   |
| Maximum cable length: | 100m/300ft between device and Ethernet switch   |
| Panel LED Indicators: | Signal Present (per input), CLIP (per input), SYNC/48V (per input),<br>16x2 character LCD Display, CobraNet™ conductor, Network link active,<br>Data activity |
| Mains Voltage:        | 85-270V AC, 50/60Hz   |
| Power Consumption:    | <35VA   |

*BSS Audio has a policy of continued product improvement and accordingly reserves the right to change features and specifications without prior notice.*

#### BSS Audio

A Division of Harman International Industries Ltd.  
Cranborne House, Cranborne Road, Potters Bar,  
Herts, England EN6 3JN  
Tel: +44 (0)1707 660667 Fax: +44 (0)1707 660755  
e-mail: info@bss.co.uk www.bss.co.uk

#### BSS Audio USA

8500 Balboa Blvd., Northridge, CA 91329, USA  
Telephone: 818.920.3212 • Toll Free: 888.251.8351  
Fax: 818.920.3208  
e-mail: BSSAudioUSA@harman.com

