



## User Manual

### DSP-AEC-0606 Audio DSP with AEC 4-in/4-out analog and 2x2 USB



All Rights Reserved

Version: DSP-AEC-0606\_2023V1.1

## Preface

Read this user manual carefully before using the product. Pictures shown in this manual are for reference only. Different models and specifications are subject to real product.

This manual is only for operation instruction, please contact the local distributor for maintenance assistance. The functions described in this version were updated by June 2023. In the constant effort to improve the product, we reserve the right to make functions or parameters changes without notice or obligation. Please refer to the dealers for the latest details.

## FCC Statement

This equipment generates, uses and can radiate radio frequency energy and, if not installed and used in accordance with the instructions, may cause harmful interference to radio communications. It has been tested and found to comply with the limits for a Class A digital device, pursuant to part 15 of the FCC Rules. These limits are designed to provide reasonable protection against harmful interference in a commercial installation.

Operation of this equipment in a residential area is likely to cause interference, in which case the user at their own expense will be required to take whatever measures may be necessary to correct the interference.

Any changes or modifications not expressly approved by the manufacture would void the user's authority to operate the equipment.



## SAFETY PRECAUTIONS

Please read this manual before installing or using the product. Review the following safety precautions.



The lightning symbol in the triangle is used to alert you to the presence of dangerous voltage inside the product that may cause a risk of electric shock to anyone opening the case. It is also used to indicate improper installation or handling of the product which could damage the electrical system of the product or other equipment connected to the product.



The exclamation point in the triangle is used to alert you to important operating and maintenance instructions. Failure to follow these instructions may result in injury or product damage.



Be careful with electricity:

- **Power Outlet:** To avoid electric shock, make sure that the electrical plug used on the product power cord matches the electrical outlet used to supply power to the TiGHT AV product. Use the power adapter and power connection cables designed for this unit.
- **Power Cord:** Make sure the power cord is routed so that it will not be walked on or pinched by heavy objects.
- **Lightning:** To protect against lightning or when the product is left unattended for a long period of time, unplug it from the power source.



Also follow these precautions:

- **Ventilation:** Do not block the ventilation slots, if any, on the product or place heavy objects on it. Blocking the airflow could cause damage. Arrange the components so that air can circulate freely. Ensure adequate ventilation if the product is placed on a stand or cabinet. Place the product in a well-ventilated place, away from direct sunlight or any heat source.
- **Overheating:** Avoid stacking the DSP-AEC-0606 on top of a hot component, such as a power amplifier.
- **Risk of Fire:** Do not place the unit on top of easily combustible materials, such as rugs or fabrics.
- **Proper Connections:** Make sure all cables and equipment are connected to the unit as described in this manual.
- **Object Entry:** To avoid electric shock, never stick anything in the slots on the case, or remove the cover when connected to a power supply.
- **Water Exposure:** To reduce the risk of electric shock or fire, never expose the unit to rain or moisture.
- **Cleaning:** Do not use aerosol cleaners or liquid to clean this unit. Always unplug the power source to the device before cleaning the unit.
- **ESD:** Handle this unit with proper ESD care. Failure to do so can result in failure.

## Table of Contents

Quick Start Guide .....	5
1. Product Introduction.....	6
1.1 Key Features .....	6
1.2 Package List.....	6
1.3 Customer Service .....	7
1.4 Technical Specifications .....	7
1.5 Front Panel Features.....	9
1.6 Rear Panel Features .....	9
1.7 Signal Flow Chart.....	11
2. DSP Software .....	12
2.1 Software Requirements .....	12
2.2 Software Installation .....	12
2.3 Software Operation .....	12
2.3.1 File Menu .....	13
2.3.2 Settings Menu .....	14
2.3.2.1 Device Settings .....	14
2.3.2.2 Group Settings .....	15
2.3.2.3 Preset Name .....	16
2.3.2.4 Panel Setting.....	16
2.3.2.5 User Interface .....	18
2.3.3 Help Menu.....	20
2.3.3.1 About .....	20
2.3.3.2 Support .....	20
2.3.3.3 Command copy.....	20
2.3.4 Theme Menu .....	21
2.3.4.1 Light Mode .....	21
2.3.4.2 Dark Mode .....	22
2.3.5 Device List.....	22
2.3.6 Top Right Settings .....	23
2.3.7 Home Tab .....	23
2.3.8 Module Tabs .....	25
2.3.8.1 Inputs / Outputs.....	25
2.3.8.2 AutoMixer.....	25

2.3.8.3 AEC (Acoustic Echo Cancellation).....	27
2.3.8.4 ANS (Automatic Noise Suppression) .....	28
2.3.8.5 Matrix .....	28
2.3.8.6 Meters .....	29
2.3.9 Channel Processing Modules.....	30
2.3.9.1 Input Source.....	30
2.3.9.2 Expander (Inputs) .....	30
2.3.9.3 Compressor (Inputs) .....	31
2.3.9.4 AGC (Automatic Gain Control) (Inputs).....	32
2.3.9.5 PEQ .....	33
2.3.9.6 Adaptive Feedback Suppression (Inputs) .....	34
2.3.9.7 Filter (Outputs).....	35
2.3.9.8 Delay (Outputs).....	37
2.3.9.9 Limiter (Outputs) .....	37
2.3.9.10 Output Setting .....	38
2.3.10 USB Soundcard .....	39
3. Control .....	39
3.1 External Control Programmer.....	39
3.2 Control Protocol.....	39
3.2.1 V1 Protocol.....	40
3.2.2 V2 Protocol.....	40
3.2.3 Preset Structure (V1 and V2 protocol) .....	41
3.2.4 UDP to RS232/RS485 (V2 protocol only).....	41
3.2.4 RS232/RS485 to UDP (V2 protocol only).....	42
3.2.5 Central Control Response control ON/OFF (V2 protocol only):.....	43
3.2.6 Feedback and response to SET or GET commands (V1 and V2).....	43
3.3 Appendix A: Module ID.....	44
3.4 Appendix B: Module Parameters.....	45
3.5 Appendix C, Command Structure Examples .....	53
3.5.1 V1 examples .....	53
3.5.2 V2 examples .....	57
4. Environment and recycle information.....	59
4.1 Disposal of electric and electronic devices EC Directive 2012/19/EU .....	59
4.2 Packaging recycling information.....	59

## Quick Start Guide

1. Install the TiGHT DSP software found on the product page at [www.TiGHTAV.com](http://www.TiGHTAV.com)
2. Connect the computer running the software directly to the DSP via network cable, or connect to the same network.
3. Open software and click "Device List" in the top right corner and connect to the DSP.
4. Make sure your computer and TiGHT DSP are connected on the same network and using correct IP settings.
5. Click on "Connect".

You're all set, enjoy your TiGHTAV product!



## 1. Product Introduction

Thanks for choosing the TiGHT AV DSP-AEC-0606. The DSP-AEC-1410 is an audio signal processing unit with 12 analog inputs, 8 analog outputs as well as 2x2 USB Audio interface for computer.

The unit is configured and controlled from a Windows application that presents an easy to use GUI. Powerful processing with eq, dynamics, ducker, mixer, matrix and camera tracking combined with advanced acoustic echo cancellation (AEC) makes this unit suitable for a wide range of use cases. For critical applications the unit supports redundancy mode.

Analog audio inputs supports both microphone and line level sources. Phantom power is selectable individually for each channel.

USB connection to host computer works as a sound card for easy computer audio connectivity for conference calls, playback and recording.

### 1.1 Key Features

- 4x4 analog inputs and outputs
- 2x2 USB channels with processing for computer audio playback and recording
- Powerful DSP processing with matrix and mixer
- Advanced AEC (Acoustic Echo Cancellation)
- Easy to use GUI
- 16 user configurable presets for easy recall
- Device snapshot export and mass import
- Light or dark theme selections
- Open API for external control via ethernet (UDP) or RS-232/485
- External control from custom software or 3rd party control systems

### 1.2 Package List

- 1 x DSP-AEC-0606
- 2 x Mounting Brackets for surface mounting
- 2 x Mounting Brackets for 19" rack mounting
- 6 x Mounting screws
- 4 x 6-pin and 2 x 3-pin Terminal Block
- 1 x 1,5m USB 2.0 cable (Type A to Type B)
- 1 x EU/UK power supply
- 1 x Screwdriver
- 4 x Rubber Feet

**Note:** Please contact your distributor immediately if any damage or defect in the components is found.

### 1.3 Customer Service

TiGHT AV provide a limited warranty for the product within **five years** counting from date of purchase (The purchase invoice shall prevail).

For more information see TiGHT AV general Warranty Statement at <https://tightav.com/warranty-statement> or just scan the QR-code.



### 1.4 Technical Specifications

<b>DSP Processor</b>	
Type	ADI SHARC 21489
DSP Handling Capacity	400 MIPS, 1,6 GFLOPS
<b>Input</b>	
Inputs	(4) Analog Mic/line Audio
Input Connector	(2) 6-pin Green Terminal Blocks
Phantom Power	48V (Max 10mA), selectable per input
<b>Output</b>	
Outputs	(4) Analog Line Audio
Output Connector	(2) 6-pin Green Terminal Blocks
<b>Interface</b>	
Ethernet	LAN, 10/100/1000 Base-T Ethernet
Ethernet Connector	(2) RJ45
PoE	802.3af
USB	(1) USB 2.0, Type B
Serial	(1) RS-232, (1) RS-485
Serial Connector	(2) 3-pin Green Terminal Blocks
<b>Audio Performance</b>	



**Audio DSP with AEC, 4-in/4-out analog and 2x2 USB**

Input Gain	0 - 48dB in 6dB steps
Frequency Response	±0.5dB (20Hz~20KHz)
Maximum Level	+18dBu
THD + Noise	0.003%@4dBu
Input Dynamic Range	110dB
Output Dynamic Range	112dB
Background Noise (A-weighted)	-91dB
Common Mode Rejection Ratio @60Hz	80dB
Channel Isolation @1KHz	108 dB
Input Impedance (Balanced)	5.6kΩ
Output Impedance (Balanced)	102Ω
System Latency	<3ms
Sample Rate	48 kHz
Bit Depth	24 Bit
<b>General</b>	
Power requirements	PoE 802.3af or 12VDC
Power adapter	AC110~240V 50Hz-60Hz, 12VDC / 2A output
Maximum Power Consumption	10W
Rack Space	Half Rack
Dimensions with terminal blocks (W x D x H)	215mm x 192mm x 44mm
Shipping Weight	2kg
Operating Temperature	0 ~ +40°C
Storage Temperature	-25 ~ +70°C
Relative Humidity	10% - 90%
<b>Compliance</b>	
Compliance	FCC, CE
Environmental Compliance	RoHS, REACH, WEEE

### 1.5 Front Panel Features

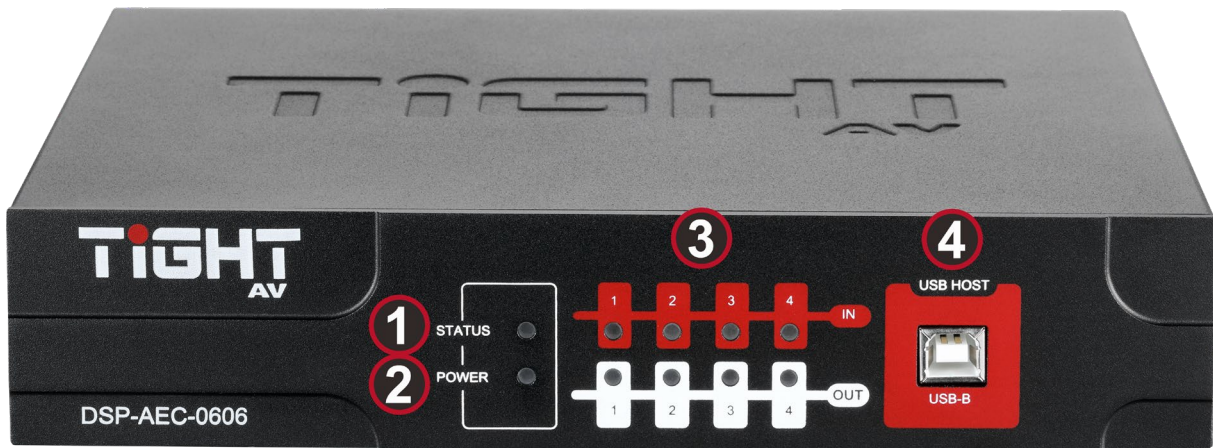

1. **Status LED:** A green LED indicates network connection on the Local Area Network and program is running.
2. **Power LED:** A green LED indicates the unit is receiving power.
3. **I/O LEDs:** A green LED indicates the unit receiving analog signal.
4. **USB Audio:** USB soundcard connection for Audio over Type-A USB cable.

### 1.6 Rear Panel Features

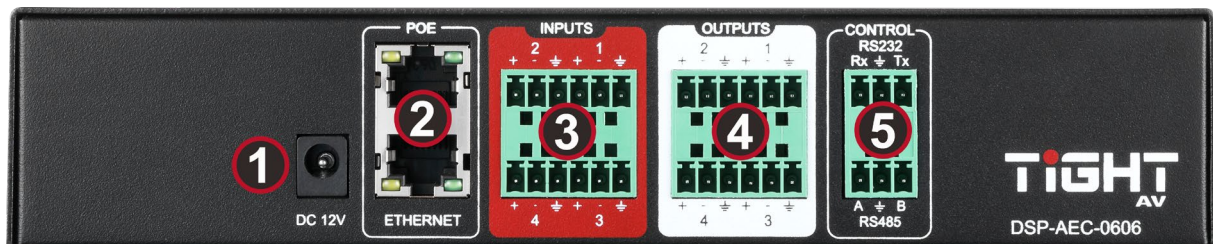

1. **DC Power Input:** 12VDC, 10W, center positive power input. Acts as alternate power source to PoE. For redundancy power, use simultaneous DC Power Input and PoE.
2. **ETHERNET / PoE Port:** connector, this interface is used for communication with computer software and any third-party external controller.  
**ETHERNET Port:** Secondary 100 Base-T Ethernet port
3. **Analog Inputs:** Balanced or Unbalanced high impedance inputs. Line or Mic Level supported with +48VDC phantom power.

	Signal Label	XLR	TRS
	+	Pin 2	Tip
	-*	Pin 3	Ring
	⏏	Pin 1	Sleeve
*used with "jumper" when using unbalanced			

4. **Analog Outputs:** Balanced or Unbalanced outputs. 24bit DA Conversion.

**Audio DSP with AEC, 4-in/4-out analog and 2x2 USB**

	Signal Label	XLR	TRS
	+	Pin 2	Tip
	-*	Pin 3	Ring
	⏏	Pin 1	Sleeve
*do not use (-) for unbalanced			

**5. Serial Communication:** RS-232 connections for remote control devices, such as a control panel.

	Signal Label	Signal
	Rx	RS-232 Receive
	⏏	Ground
	Tx	RS-232 Transmit

### 1.7 Signal Flow Chart

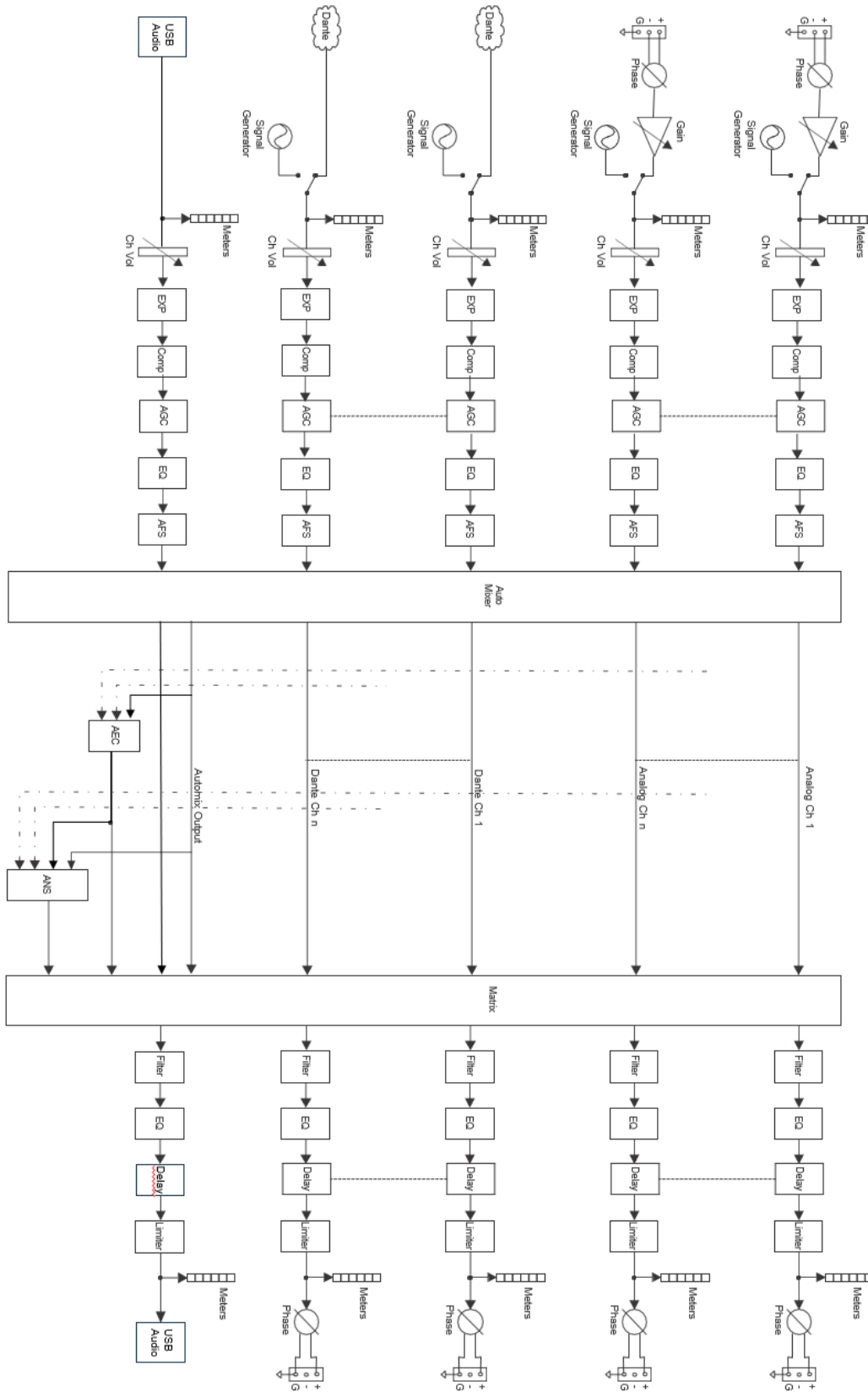

## 2. DSP Software

### 2.1 Software Requirements

#### TiGHT AV DSP software:

- A Windows computer with a processor of 1 GHz or higher and: Windows 7 or higher version.
- 1 GB free storage space.
- 1024 x 768 resolution.
- 24 bit or higher color.
- 2GB or higher memory.
- Network (Ethernet) port.

#### Audinate software's:

Refer to Audinate minimum requirements recommendations.

### 2.2 Software Installation

1. Download software from the DSP-AEC-0606 product page at <https://www.TiGHTAV.com/>. Or open a web browser and type in the IP address of the DSP's control interface and download the software stored on the device.
2. Double click the downloaded file and install by following the instructions on the screen.
3. After installation is complete, launch the software by clicking the following icon:
4. Wait for the software to launch, may take 1-15s to start.



### 2.3 Software Operation

After the software has opened, click "OK" on your selected model (this startup selection box can be turned off under "Device Settings").

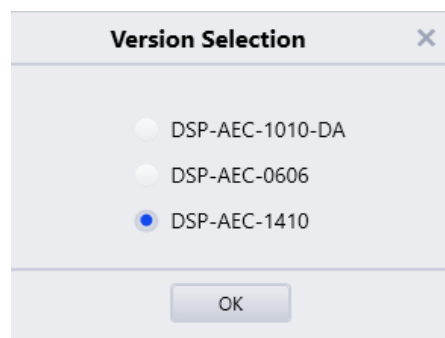

To connect to the DSP click on "Device List" and choose your DSP from the list. Then click "Connect". The software will automatically scan the network for available DSPs. The software will be able to find DSPs even if they are not configured with an IP address according to the computer network configurations as long as the DSP can be reached.

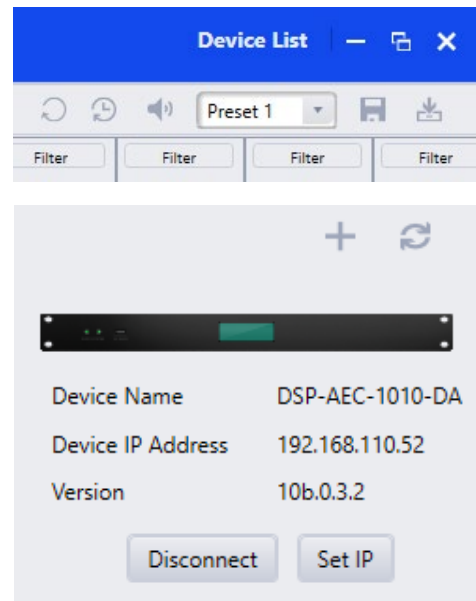

First time setup of a DSP, the DSP will have the default static IP-Address 169.254.10.227 with subnet mask 255.255.0.0. Click "Set IP" button to configure a new static IP address. If DHCP is needed connect to the DSP then go to "Settings" tab and select "Device settings" (see section Device settings)

The following shows the Home Tab view of the interface using Light Mode theme. Use button and select model to add multiple DSPs to control simultaneously.

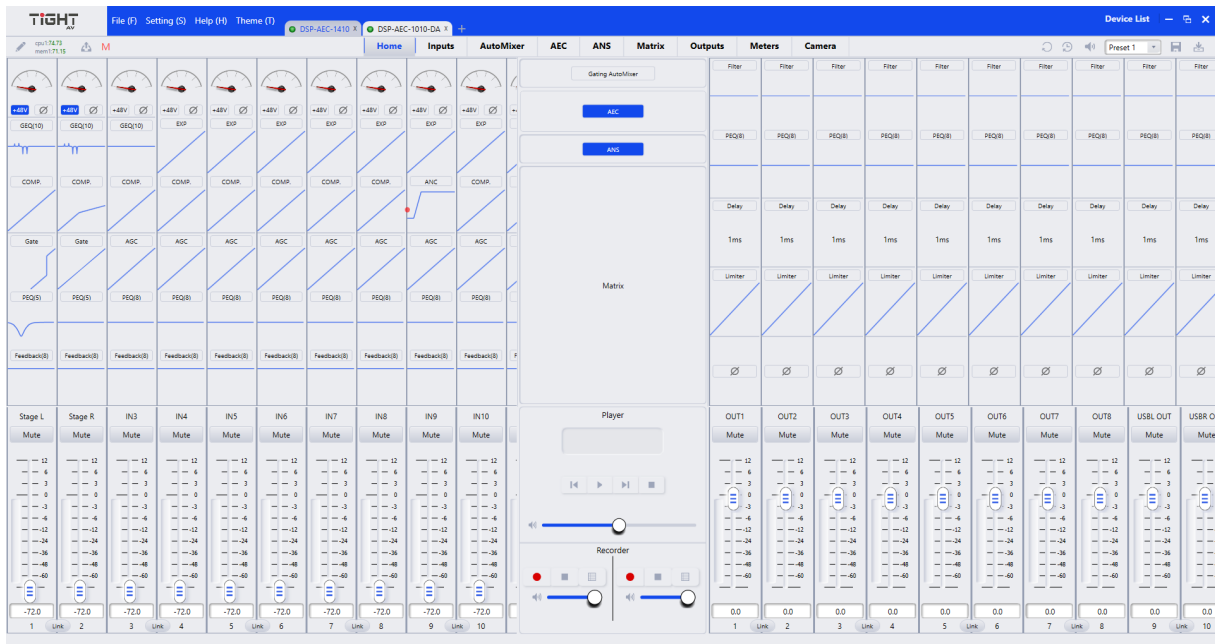

### 2.3.1 File Menu

**Open:** The File Menu gives you the option of importing saved presets from your computer or saving presets to your computer.

**Note:** This option is only available offline. To import presets from your computer to an online DSP use the "Import Preset" feature described in section 2.3.6.

**Save As:** Export current preset and save on your computer.

**Export All:** Exports a full device snapshot with all configurations and presets. IP settings will not be exported. Save snapshot file on your computer.

**Import All:** Imports a snapshot file stored on a computer.

Note: Unit will disconnect after import is done and users need to connect again.

## 2.3.2 Settings Menu

For the Device Settings Menu to be accessible the software and DSP-AEC-0606 must be connected.

### 2.3.2.1 Device Settings

**Device Name:** Set the name of the device and the name will display anywhere the device is addressed. The name is saved into the hardware.

**Device IP Address:** Set the IP address of the LAN interface.

**Gateway:** Set the default gateway for the network.

**Netmask:** Set the network mask associated with the desired subnet.

**Mac Address:** Shows the MAC address of the control interface.

Note:

**Default Preset:** Sets the default preset the device loads upon a power cycle event. Can be set to one of the 16 presets or set to last active preset prior to the power cycle.

**Central Control Response:** Enable this when using an external controller that expects a response to control messages (see Appendix C, Command Structure Examples).

**Real Time Save:** When enabled, active preset changes are saved in real time. Enable this will ensure the exact state of the device to be restored upon a power cycle if "Previous Loaded Preset" is selected in the "Default Preset" parameter. If Real Time Save is set to "Off", changes that are not manually saved will be lost after a power cycle.

**Enable Model Selection Box:** When enabled, upon starting the software the model selection window will appear.

**UDP Control Port:** Shows the UDP control port for remote communication with the DSP-AEC-0606.

**RS-232/RS-485:** Set the baud rate, Data bit, Stop bit and Parity bit for the serial port of the device.

**OK:** All settings done in the Device Setting window are saved to the device and the window will close.

**Cancel:** Will close the window and no changes are saved.

### 2.3.2.2 Group Settings

The group setting window has separate tabs for input and output groups. 5 groups can be set in each tab. A channel can only participate in one group. In the same group, the channel volume/gain control and mute functions are linked. Individual level differences are kept. Other functions are not linked. For pairwise linking of all channel parameters, use the link button below the channel fader.





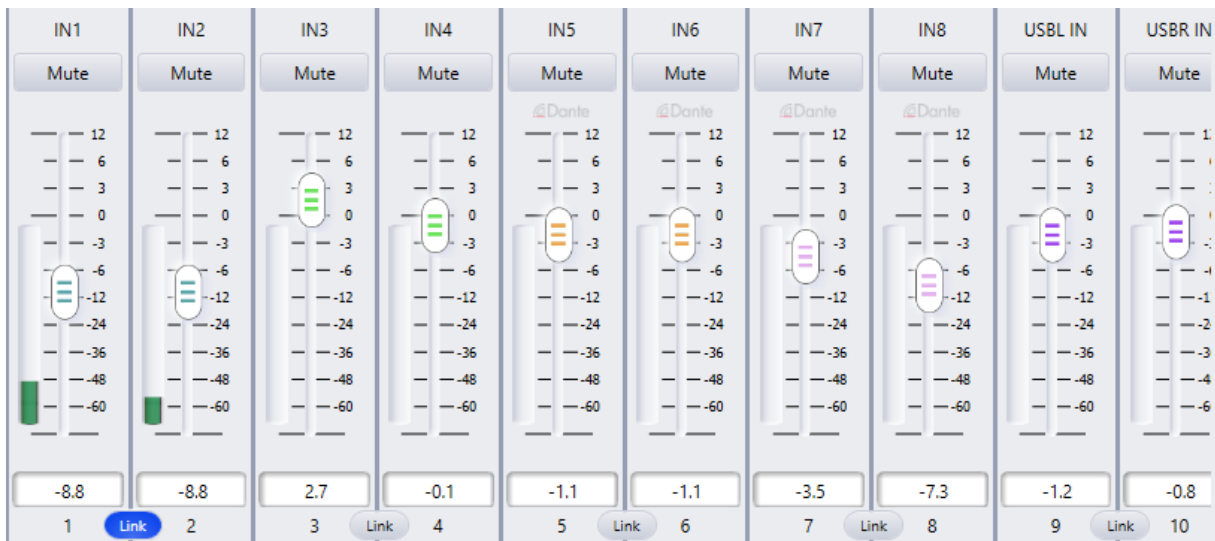

**The relationship between groups and link:** The channel participating in a group will not participate in LINK, which means the group’s priority is higher than LINK. The difference between groups and LINK is that groups can only control channel gain and mute, while LINK includes all parameters in the channel. LINK sets volume/gain to same value whereas the Group keeps the differences set by the faders.

### 2.3.2.3 Preset Name

In this window, all 16 preset names can be changed in one window.

All changes made here will correspond to other features in the software where Preset Names are available.

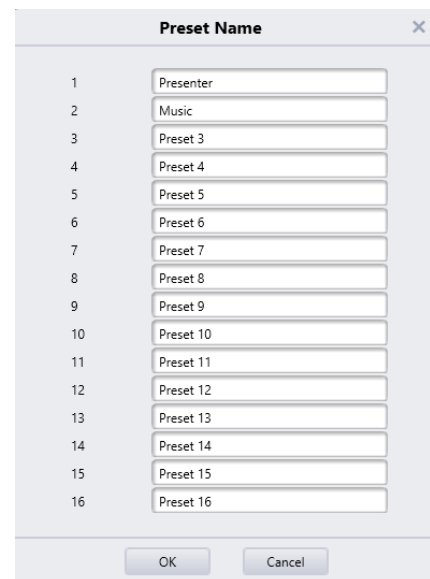

### 2.3.2.4 Panel Setting

Panel configuration page for button and OLED panels. Use network cables to connect multiple physical panels with DSP devices via the network switch(es).

**Offline devices:** Panels can be configured offline for later upload on-site commissioning.

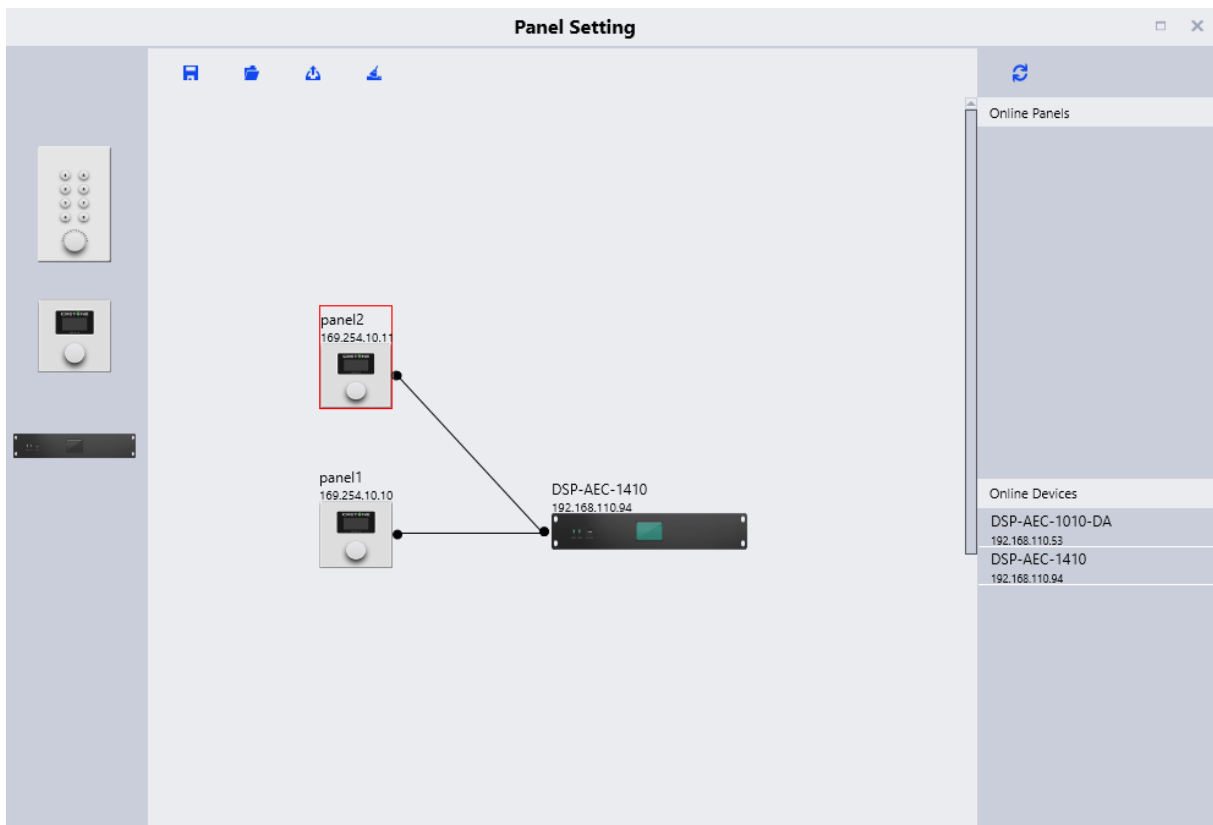

Drag offline device from the sidebar to panel design area and double click to edit it.

Note the small circle on both panel and device. Click the circle and draw a line between the units to establish the connection between panel and the DSP device to be controlled.

Double click on the panel in the design area to enter panel configuration interface.

After finishing configuration, click the toolbar download icon  to download the panel configuration to the panel hardware.

### Edit panel:

The OLED panel consists of a 1.3” OLED screen and a knob. The panel functions are added in a list, and a single encoder is used for selecting the function and parameter adjustment.

Click "add menu" to show menu selection box. Choose corresponding menu item and configure it. After finishing the setup, click the toolbar download icon to download the configuration to panel hardware.

Panel menu navigation:

1. Display panel name and IP address on main interface and turn the knob left or right to select function.
2. Press the button on the knob, and the second row on menu interface starts to flash which indicates edit mode.
3. Turn the knob left or right to change value.
4. Press the button on the knob again to exit edit mode and go back to menu mode.



### 2.3.2.5 User Interface

The User Interface menu opens up the User Interface Window. This feature allows the user to fully customize a control panel for hand-held devices such as smartphones, designed to suit the needs of the end user.

The hand-held device must have the app DSP Pro 2 installed in order to use the designed control panel. The app is available on the App Store for apple devices. Android devices is not supported at this stage.



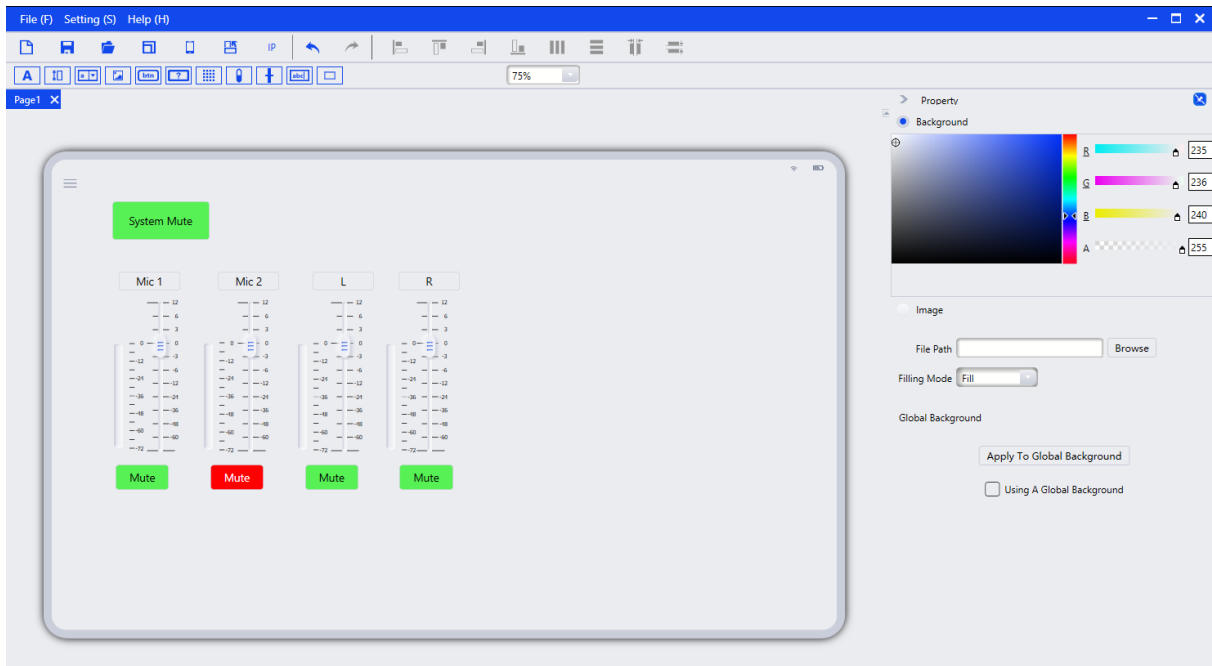

**New Page:** Opens up a new empty design page.

**Save:** Saves the user's current design.

**Open:** Allows the user to open a previously created panel design.

**Template:** Allows the user to choose from specific templates based on common hand-held devices.

**Sync:** This will open up the Sync Window. In this window all discovered compatible devices on the network will appear that has the DSP Pro v2 app installed and open. Click on your desired device and then click sync to connect the control panel and the hand-held device. Using the DSP Pro v2 app the control panel will then be available in the app for usage.

**Rotate:** This will rotate the chosen template. Note that all current objects in the layout will not be adjusted. Therefore, decide first if the panel will be horizontal or vertically before designing the layout.

**Quickly Change IP:** This will open a window for the user to quickly change the source address and destination address, and also the range of pages the changes will apply to.

## Designing the Control Panel Layout

By simply drag-and-drop different objects on to the chosen template, each object will be added to the design.

Each object will have its customizable features available on the right side of the window. In this case, the button has been labeled "System Mute", and by opening the "Command" pane the type of command string can be added. Every command is available by using the "Central Control Command" option in the "Help Menu".

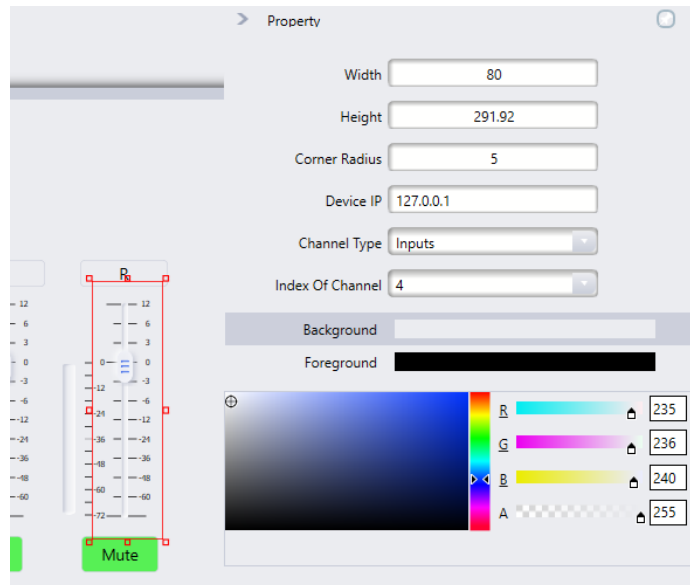

For more information and details of the User Interface, please watch the User Interface tutorial video series on [www.TiGHTAV.com](http://www.TiGHTAV.com) or the TiGHT AV YouTube Channel.

## 2.3.3 Help Menu

### 2.3.3.1 About

In this window the software version number and DSP model are displayed.

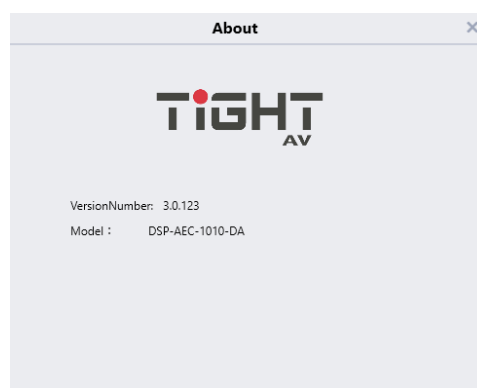

### 2.3.3.2 Support

Brings up the device manual pdf.

### 2.3.3.3 Command copy

Opens a new window showing the last or current change as a command string. When open, click on any parameter and the corresponding command string will be displayed in the window. Select if to copy the raw HEX code or the formatted version

with prefix \x. This is a very useful tool for programmers when programming third-party control systems to control the DSP.

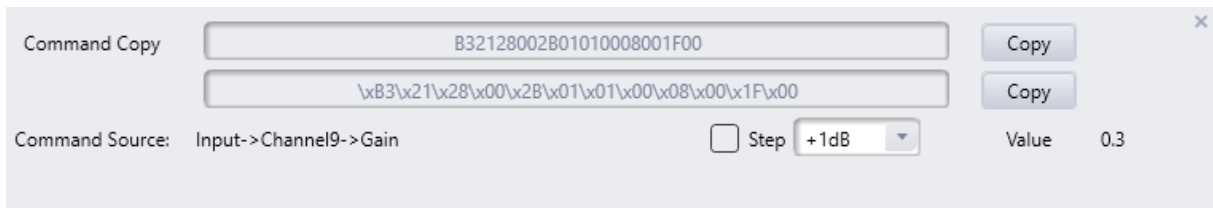

### 2.3.4 Theme Menu

Switch between using Light Mode and Dark mode GUI at user's preference.

#### 2.3.4.1 Light Mode

Light Mode is changing the GUI to using a white and blue color GUI.

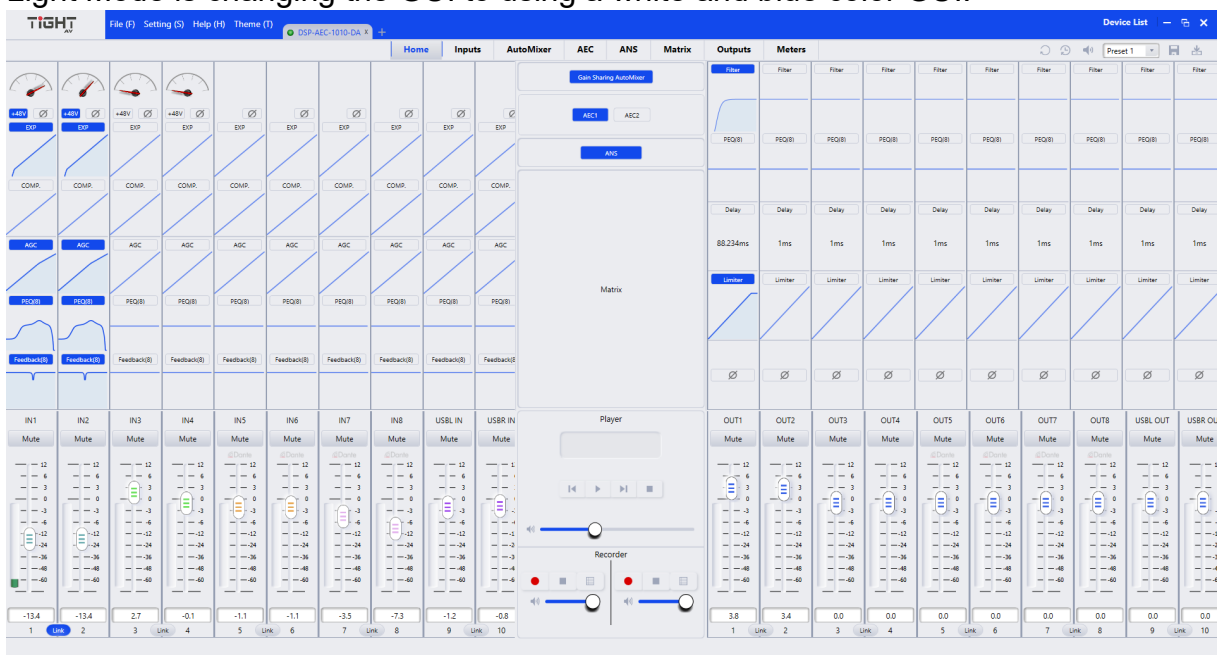

### 2.3.4.2 Dark Mode

Dark Mode is changing the GUI to using a black and teal color GUI.

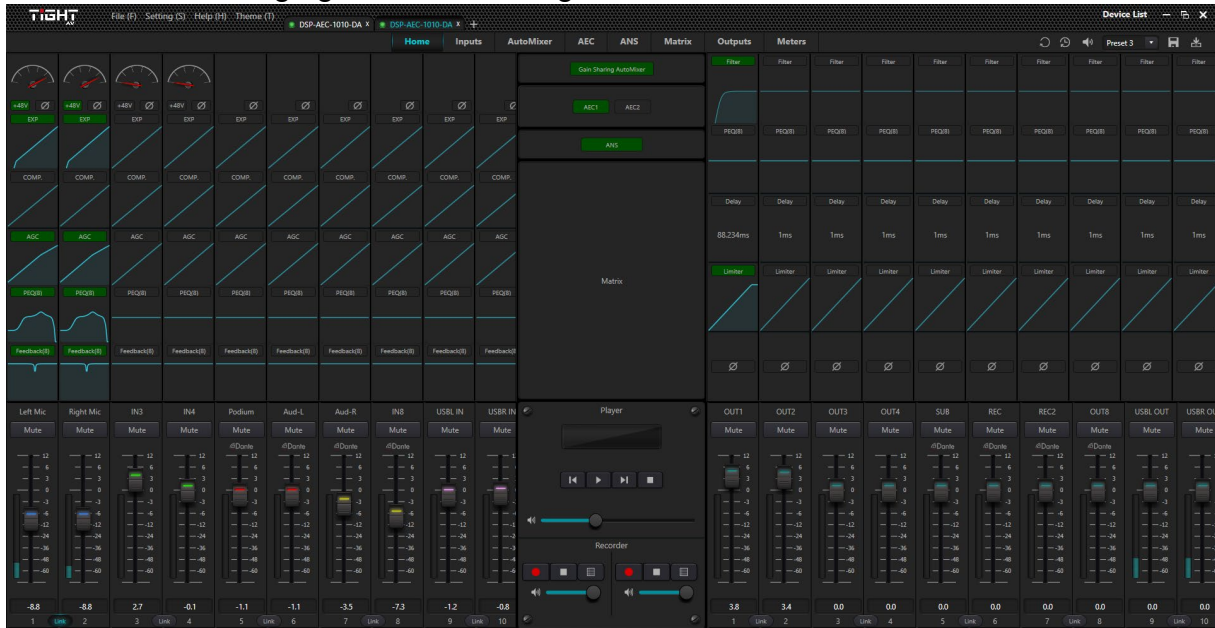

### 2.3.5 Device List

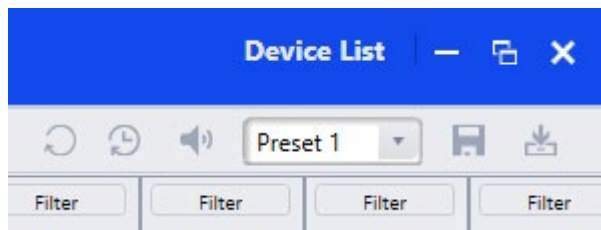

Click on the "Device List" to bring up the pane for your active devices. Software will automatically start a discovery search in the same broadcast domain as the software computer.



Click the  to manually add devices based on IP address if for example devices are located in a different broadcast domain and can't be discovered automatically.

Click the  to refresh the discovery of devices on the network.

**Device Name:** Displays the units device name, this can be changed in the Settings Menu, Device Setting option.

**Device IP address:** Displays the units IP address, this can be changed in the Settings Menu, Device Settings option.

**Version:** Displays the units current version.

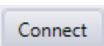
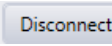
**Connect / Disconnect:** When the DSP-AEC-0606 is on the same network as your computer running the software the  button will be available. Click on the button to connect to your device. As the button changes to  the unit is online and connected.

**Set IP:** Configure a static IP address and subnet mask.

Note: Set Default Gateway address in Device Settings described in section 2.3.2.1 Device Settings

### 2.3.6 Top Right Settings

1. **Reset to default:** Resets the configuration to the chosen default preset set in the Settings Menu - Device Setting window.
2. **Restore Factory Settings:** Reverts the configuration to the factory settings.
3. **System Mute:** When enabled, mutes all audio outputs of the device.
4. **Load Preset Menu:** Allows the user to choose a specific preset to load.  
Note: Be aware, when clicking on a selected preset the system will load it immediately.
5. **Save Preset:** Allows the user to choose a specific preset slot to save current DSP configuration to be stored locally on DSP.
6. **Import Preset:** Select a preset slot and import a previously saved preset file from your computer (see "Save As" under File menu).



### 2.3.7 Home Tab

The Home Tab is the main view of the interface for the selected device. Click the "Home" tab to access this view.

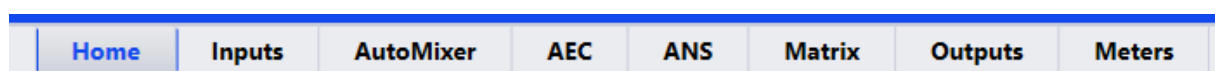



**Channel Layout:** The first four channels are the analog inputs and outputs. Channel 5 and 6 is USBL IN and USBR IN on the input side then channel 5 and 6 is USBL OUT and USBR OUT on the output side.

If the user is not in full screen mode, some channels may be hidden from view.

Navigate through the channels by hovering the mouse over the channels and using the scroll wheel up or down or click on one channel then use the keyboard arrows to navigate.

**Selecting Channels:** Click on the channel label, fader or number. This will select the active channel, the channel will get a teal or blue (depending on theme settings) border around the fader to indicate it is now selected.

**Set Channel Name:** Channel names can be set by double clicking the name plate of the channel above the fader. Type the name and hit enter to save the name.

**Set Channel Gain:** The Channel Gain can be adjusted by either moving the fader or by typing the specific value in the box directly under the fader.

**Link Button:** Toggle Channel Link by clicking the "Link" button. Each pair of channels can be directly linked to operate according to the adjacent channel's settings.

**Setting Minimum and Maximum Gain:** The default minimum and maximum gain levels on the input and output faders are set to their limits of -72dB to +12dB. By right clicking a channel fader a context menu will show which allows the user to reduce these limits.

**Accessing processing Modules:** To access processing modules such as Expander, Compressor, PEQ, AEC etc there are multiple options.

- **Right Click:** By right clicking on a module on either an input or output channel the selected parameter or module will open in a separate window while the main interface stays on the home tab.
- **Double Click:** By double clicking on a module on either an input or output channel, the selected module will appear as the active window.
- **Module Tabs:** Modules can be accessed by clicking the specific module tab next to the Home Tab.

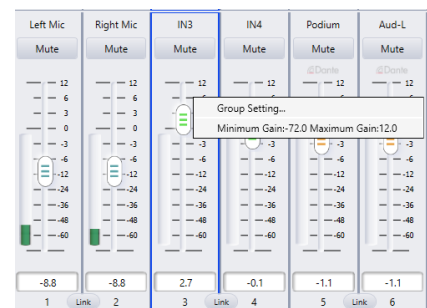
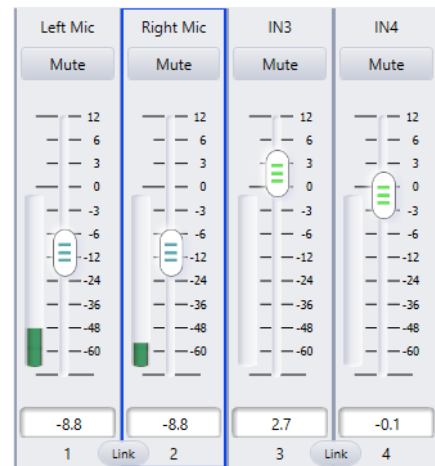

### 2.3.8 Module Tabs

There are multiple Module Tabs showing on the interface. These are Home, Inputs, AutoMixer, AEC, ANS, Matrix, Outputs, Meters. The order of these tabs is also the order of the signal flow. For example, the Automixer sits before the AEC and the AEC sits before the ANS module in the signal flow (see section 1.6 Signal Flow Chart).

#### 2.3.8.1 Inputs / Outputs

The input /outputs tabs display the fader section across the bottom. Above the faders are all the processing modules available for the channel. Scrolling up or down will navigate you through the modules.

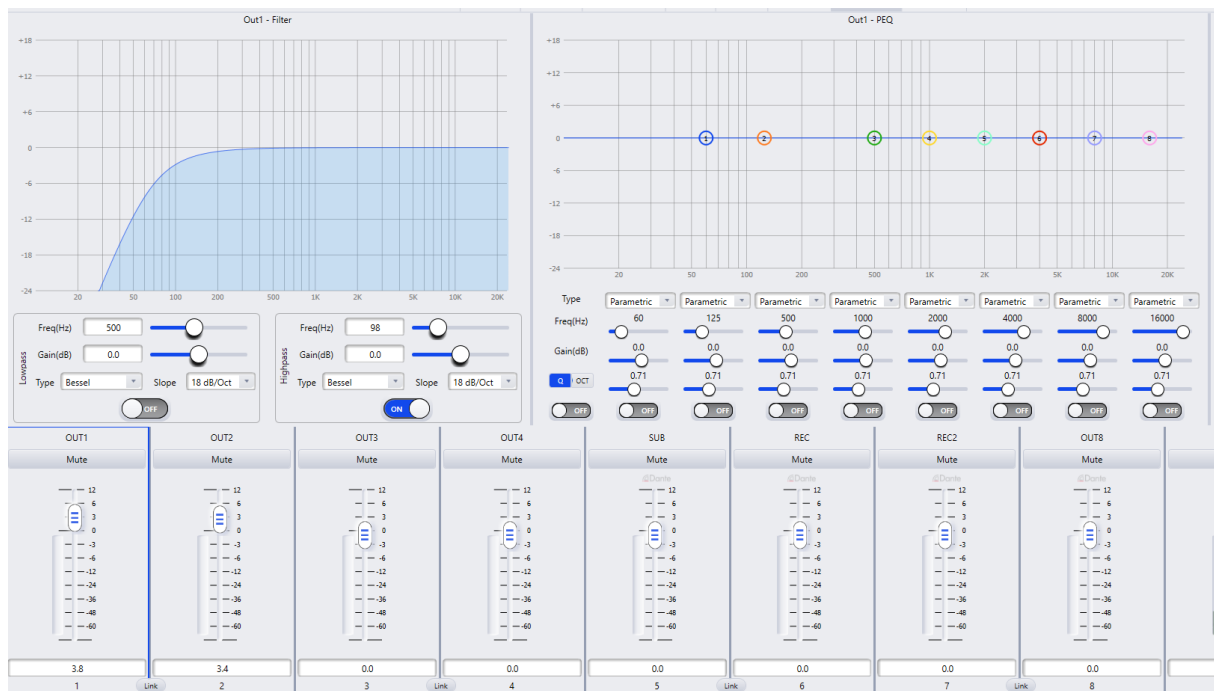

#### 2.3.8.2 AutoMixer

In the AutoMixer tab all input channels are shown with a respective fader control and mute option and routing option. Clicking on "AutoMixer" button for a certain channel will route the audio through the automixer.

The automixer is a multichannel gain sharing mixer which automatically lowers the level of non-active audio signal sources, such as a microphone, while simultaneously adjusting the level of the active sources accordingly to maintain a desired target gain. This eliminates the need for live mixing of audio sources.

Gain sharing allows for the most natural sounding mix of multiple microphones. A Gain sharing automixer uses mathematics to reduce the individual gain of a microphone as more microphones are added. For every doubling of the number of open mics, the automixer reduces the overall gain by 3dB.



**Gain(db):** Determines the desired target gain for the output of the automixer module.

**Slope:** Sets the aggression of the gain sharing- Low Slope settings cause the module to act just like a conventional mixer. High slope causes the inputs to attenuate more deeply for inactive sources, very much like a gate module. A value of 2.0 give a natural sounding effect in most applications.

**Response(ms):** Adjusts the speed at which the automixer operates. A quicker response time can be needed if different speakers are speaking in rapid succession, but a response value that is too fast could cause unwanted effects on the overall volume, such as a "pumping" sounding mix. Also, a response time set too slow could cut away the beginning of certain words. The Gain Sharing Algorithm provides for a quicker on time than off to prevent this effect. A Response value between 100ms and 1000ms will provide the most natural effect.

**Mute:** Mutes the output of the automixer.

**Fader/Gain:** Adjusts the channel gain. Channel gain is after the input to the automixer engine.

Note: Channel level can still affect the gain adjustment of other channels even if the fader is all the way down.

**Priority:** Adjusts the level of priority for the selected channel. This value feeds into the automixer engine and may influence the automatic gain adjustments decisions.  
automixer: Enables the selected channel to participate in the automix.

**AutoMixer:** When activated the selected channel is participating in the automixer.

**Mute:** Mute the selected channel. The Mute function on the channel is after the input to the automixer engines.

Note: A muted channel can still affect the gain adjustments of other channels in the automix.

### 2.3.8.3 AEC (Acoustic Echo Cancellation)

The Acoustic Echo Cancellation tab allows the user to apply acoustic echo cancellation. For audio conferencing when simultaneous or full-duplex transmission of speech is necessary, echo cancellation is an important tool to cancel out the far-end speech being transmitted back to the far-end listener as an echo.

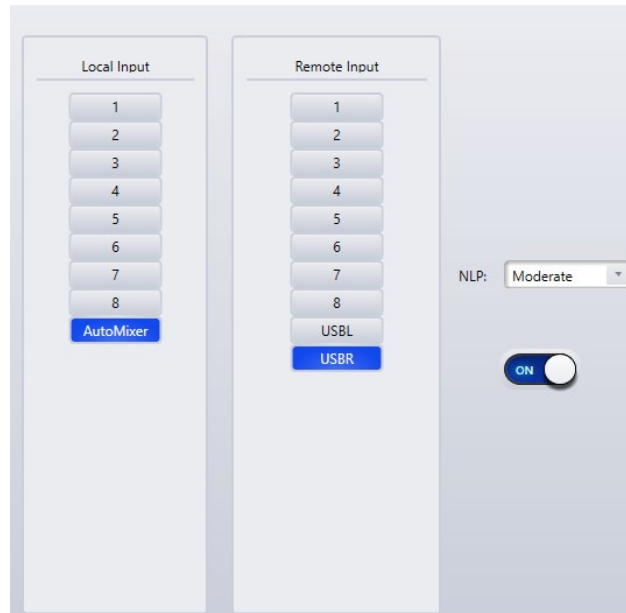

**Local Input:** Selects the audio source or sources that contains the desired audio signal as well as unwanted echoes from the remote signal.

**Remote Input:** Selects the audio source or sources for the audio signal that will be subtracted from the Local Input.

**NLP:** Non Linear Processing defines the length of time the reference (or remote) signal will be compared with the program (or local) signal and used for echo estimation. If the length of the echo is greater than the NLP value the echo will still be heard in the program signal. The following presets corresponds to the milliseconds in the columns below:

Selection	Tail Time
Conservative	128ms
Moderate	256ms
Aggressive	512ms

### 2.3.8.4 ANS (Automatic Noise Suppression)

The Automatic Noise Suppression can remove noise from the audio when detected. Because of an algorithm that distinguishes human voice from other sounds, such as constant background noise, it can detect the noise and subtract it from the audio signal.

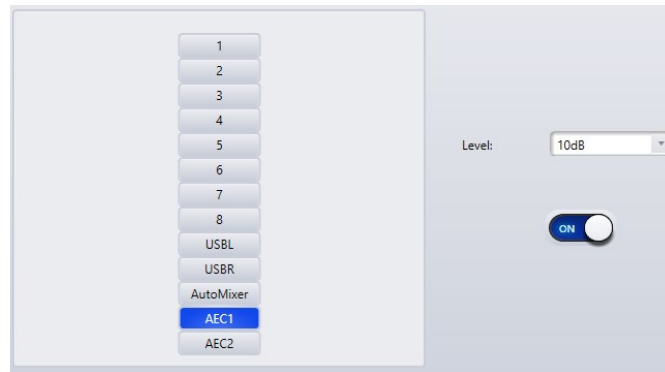

**Input Selection:** Determines what source or sources the ANS will be applied to.

**Level:** Determines the attenuation of the non-human sounds or constant background noise.

### 2.3.8.5 Matrix

The Matrix tab allows you to route inputs and modules to outputs on the device. When clicking on an intersection, the box will turn into a teal color indicating that those two channels are now connected.

By right clicking on the blue or teal intersection a small fader will appear. This gives the user the option to adjust the amount of input signal going through that specific intersection.

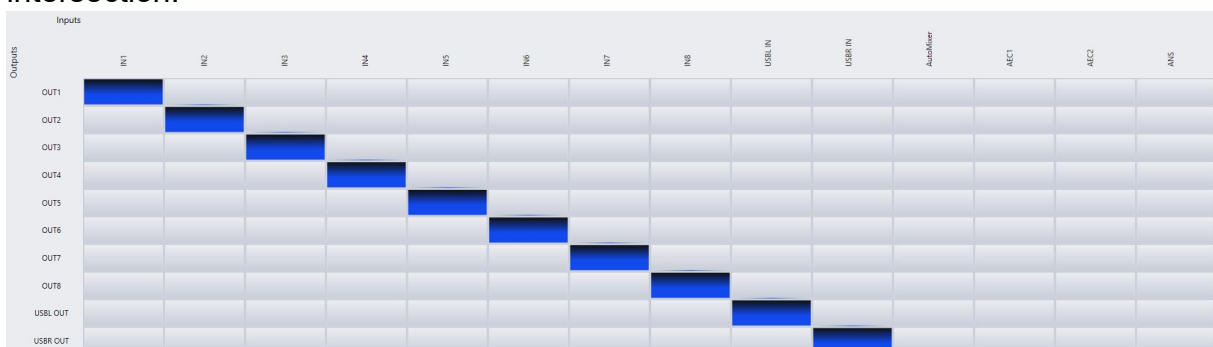

### 2.3.8.6 Meters

The Meters tab shows the input and output levels when audio is being routed through the respective channels.

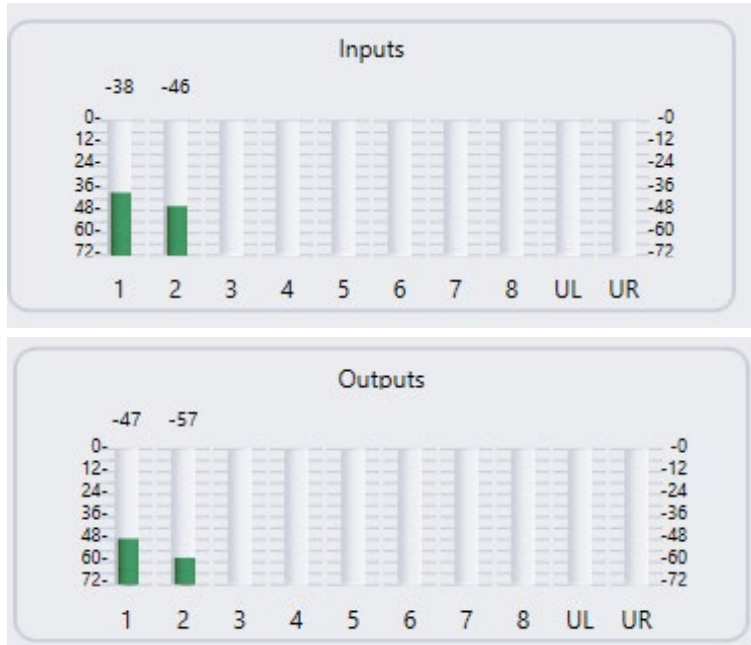

## 2.3.9 Channel Processing Modules

The DSP-AEC-0606 software is designed to be flexible and includes a wide range of modules, each providing a unique function configurable per input or output channel.

### 2.3.9.1 Input Source

The Input Source module is a fixed module on every input channel. From here the user can set the input sensitivity, enable 48v phantom power, phase shift or mute. Below is also a Signal Generator with either sinewave, white or pink noise as sound source.



### 2.3.9.2 Expander (Inputs)

The Expander module is a helpful dynamic processing tool to increase the dynamic range of an audio signal. An expander engages when the signal drops below a defined threshold. An expander can be seen as a Noise Gate but with more nuanced settings.

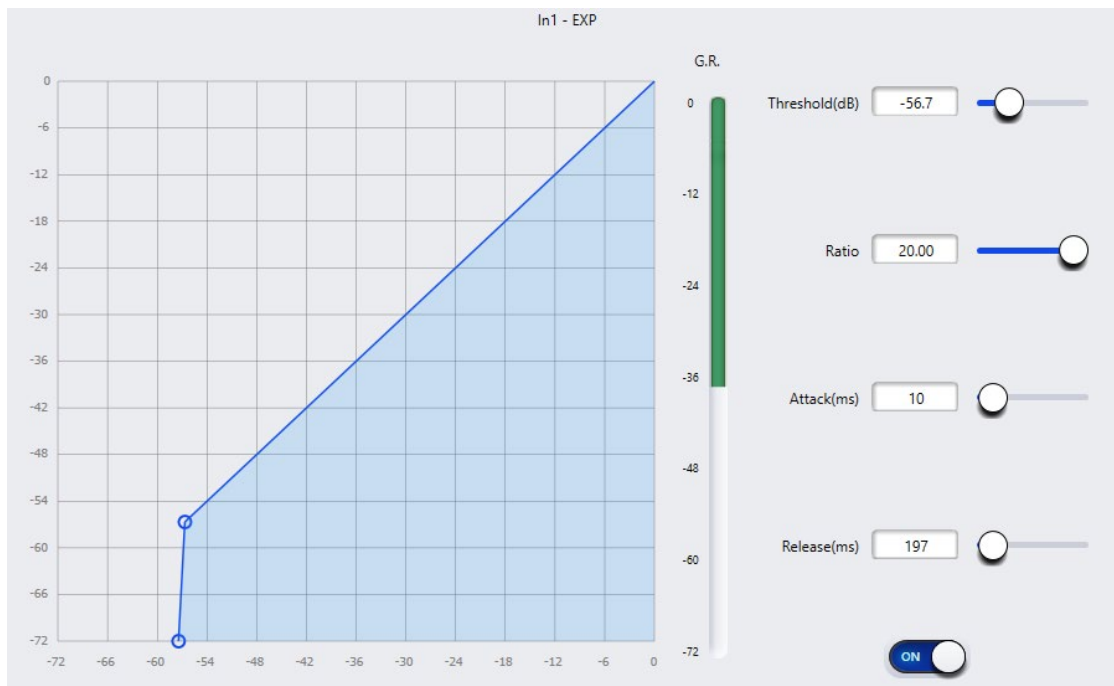

**Threshold:** The expander engages the signal when the signal falls below the threshold value.

**Ratio:** The gain curve, or amount of expansion, is defined by the ratio value.

**Attack:** The attack determines how fast the expander engages as the audio crosses the threshold.

**Release:** The release determines how fast the expander recovers after the audio returns above the threshold limit.

### 2.3.9.3 Compressor (Inputs)

A compressor reduces the amount of dynamic range in an audio signal. Dynamic range is the difference between the loudest and the quietest part of a signal. A compressor reduces this range by attenuating the louder parts of the signal and boosting the quieter parts of the signal.



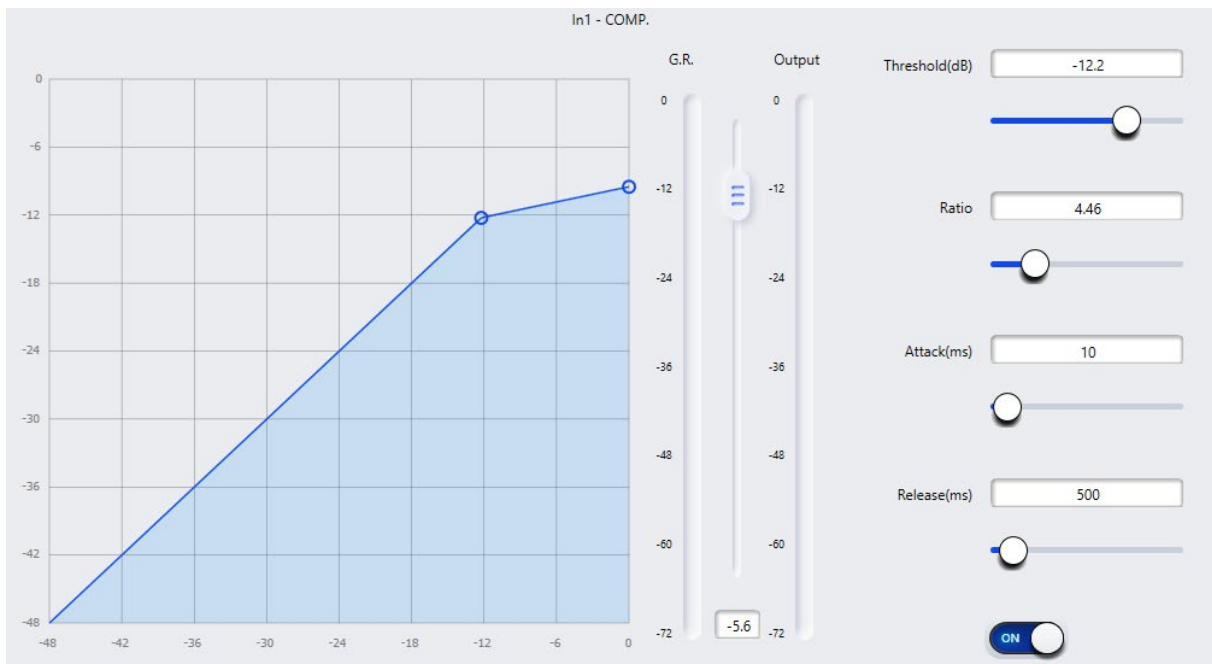

**Threshold(db):** If a signal crosses above the threshold of the compressor the compressor will be engaged.

**Ratio:** The amount of attenuation applied to the audio signal when it crosses the threshold is set by the ratio value.

**Attack(ms):** Defines the time it takes for the compressor to attenuate a signal that crosses the set threshold.

**Release(ms):** Defines the time it takes for the compressor to stop attenuating when the signal falls below the set threshold.

**G.R:** Displays the amount of gain reduction applied to the signal as it passes above the threshold.

**Output:** The fader sets the amount of gain applied to the signal after the compressor. As a signal is attenuated it may be quieter, adjust the output gain to compensate for this loss of level in the audio signal.

**ON/OFF:** Switch to enable or disable the Compression module.

#### 2.3.9.4 AGC (Automatic Gain Control) (Inputs)

Automatic Gain Control maintains the dynamic range while automatically adjusting the audio signal level. The goal of an AGC is to normalize the signal level while maintaining dynamic range. When configured correctly, a silent speaking person will

sound the same as a loud speaking person without having to manually adjust the microphone gain or mixer level.

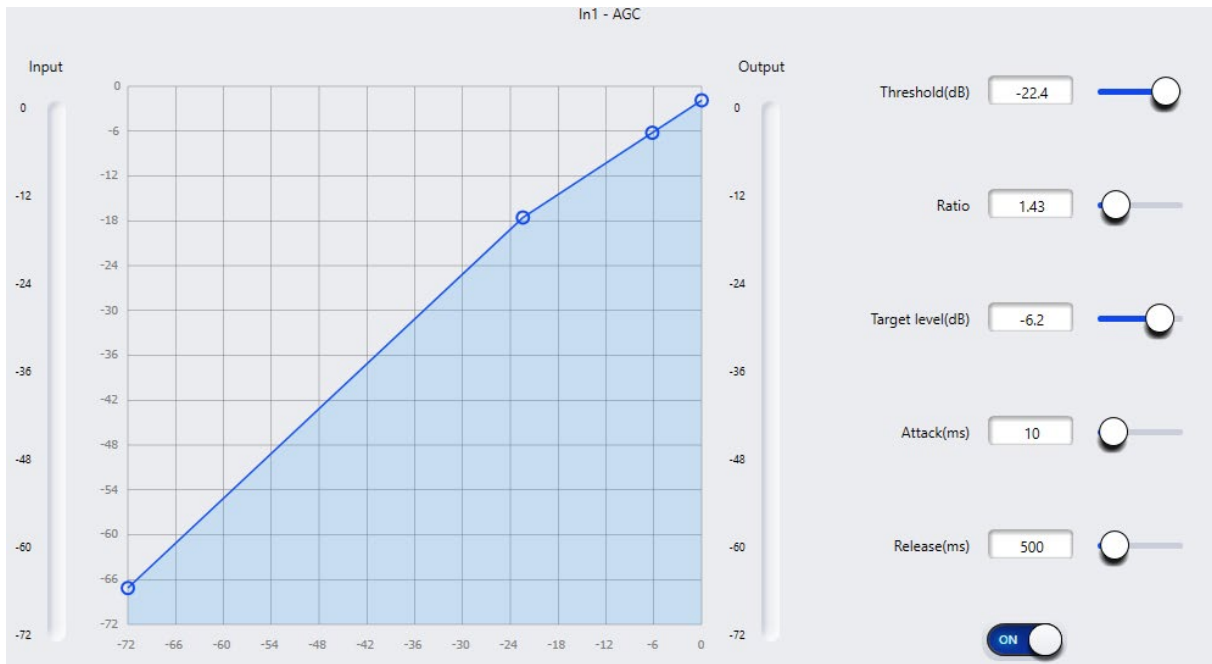

**Threshold:** When the audio signal level is below the threshold, the input-to-output ratio is 1:1. If the signal level is above the threshold level, the input-to-output ratio changes according to the assigned ratio value.

**Ratio:** Adjusts the desired ration between input/output signal.

**Target level:** Defines the desired output signal level.

**Attack:** Defines the time it takes for the AGC to engage as the signal crosses above the threshold.

**Release:** Defines the time it takes for the AGC to disengage as the signal falls below the threshold.

**ON/OFF:** Switch to enable or disable the AGC module.

### 2.3.9.5 PEQ

A Parametric Equalizer is an adjustable filter to attenuate or boost a signal frequency content of an audio signal. The PEQ allows for multiple frequency bands, or filters, with adjustable parameters.

**Type:** Parametric Equalizer is the default option. Lowshelf adds a filter controlling frequency below a certain point, highshelf does the opposite. Lowpass adds a cut off

point where all frequency content above the cut off point will be removed. The highpass does the opposite to a lowpass filter.

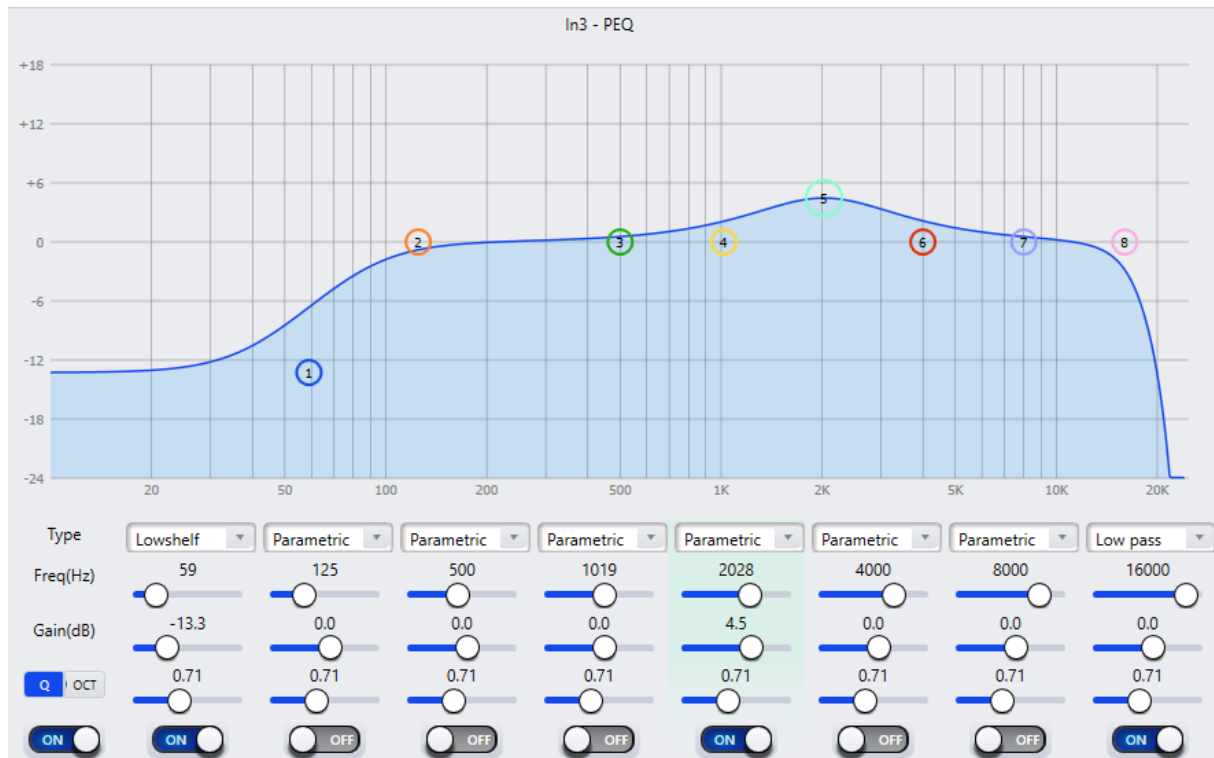

**Frequency(Hz):** Determines the center frequency of the filter.

**Gain (dB):** Determines the amount of attenuation or boosting applied at the center frequency.

**Q:** Represents the bandwidth of the filter. This sets how wide or narrow the filter will affect frequencies surrounding the center frequency.

**Q/OCT:** Changes the units from Q-value to octaves. Measuring bandwidth in octaves can provide a more musical result.

**ON/OFF:** Switch to enable or disable the PEQ filter module or individual bands.

### 2.3.9.6 Adaptive Feedback Suppression (Inputs)

The Feedback Suppression is a module on each input channel. The module detects fundamentals in the audio signal that causes feedback and adds notch filters to respected parts of the signal that causes feedback.

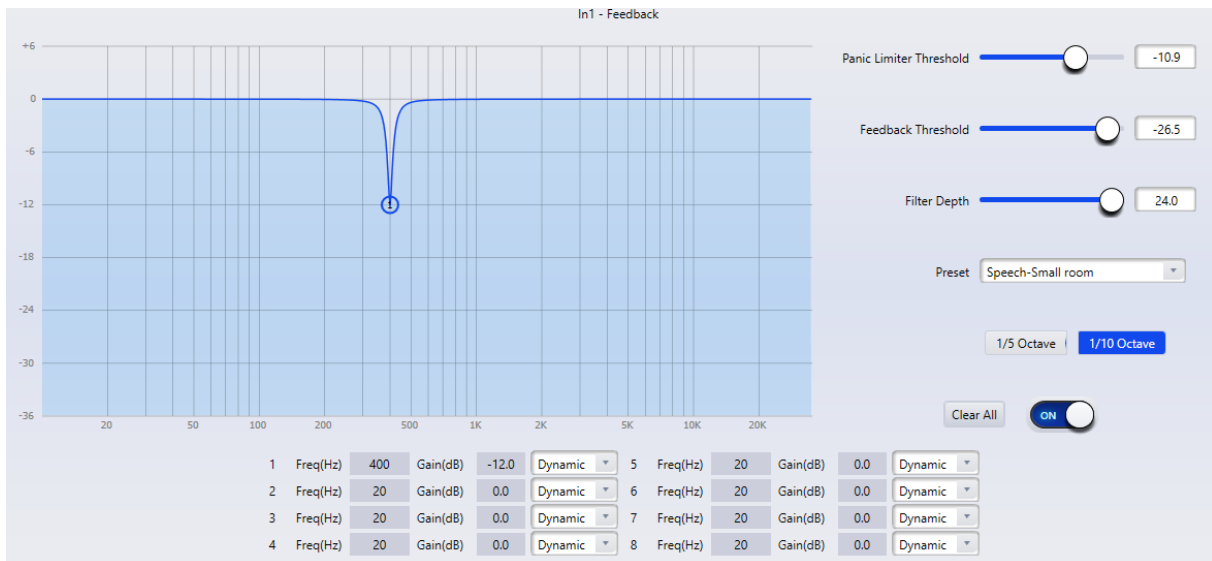

**Panic Threshold:** Any signal crossing above the Panic Threshold will be detected as feedback. When a signal crosses above any of the following will occur to attenuate the feedback:

- The gain of the signal will be attenuated to prevent the continuous feedback
- The module will limit the output signal to prevent continuous feedback
- The amount of sensitivity on each filter will be increased to provide faster detection

When the level of the audio signal falls below the threshold the settings will return to their pre-feedback event state.

**Feedback Threshold:** Any signal crossing below the Feedback Threshold will not be detected as feedback.

**Filter Depth:** Adjusts the maximum attenuation of a single filter.

**Preset:** Give the user preconfigured settings for common scenarios and venues.

**Octave Setting:** Determines the steepness of the filter notch.

**Clear All:** In a feedback event, various notch filters will be applied. To remove these filters click "Clear All". Note that turning the module **ON/OFF** does not remove the filters.

**Bandwidth:** Each filter behavior can be adjusted, either as a dynamically moving filter, a fixed filter or a manually adjusted filter.

### 2.3.9.7 Filter (Outputs)

Each output channel provides a band-pass filter module which consists of a high-pass filter (HPF) also referred to as a "low-cut filter" and a low-pass filter (LPF) also referred to as a "high-cut filter". A low-pass filter attenuates all signals above its cutoff

frequency and only allows signals below it to pass. It is the opposite of a high-pass filter, which attenuates all sounds below its cutoff frequency while only allowing those above it to pass. A band-pass filter can be a useful tool in audio mixing.

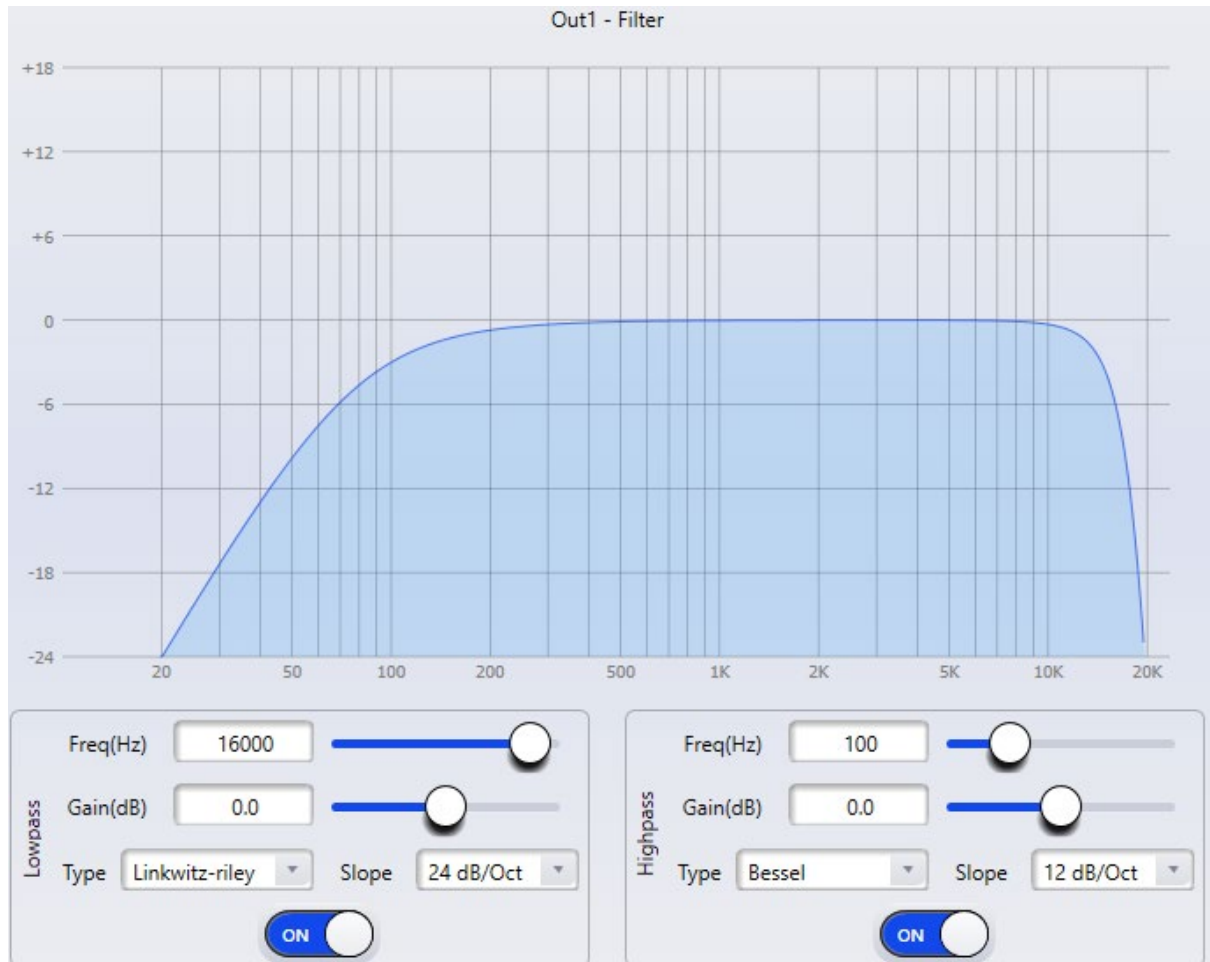

**Frequency(Hz):** Sets the cutoff frequency of each filter. The cutoff frequency of Bessel and Butterworth are selectable in -3 dB steps, and the cutoff frequency of Linkwitz-Riley are selectable in -6dB steps.

**Gain(dB):** Sets the gain or attenuation level for the signal.

**Type:** There are three types of filters to choose from; Bessel, Butterworth, and Linkwitz-Riley.

**Slope:** Refers to the attenuation of the transition zone of the filters. There are a total of 8 attenuation values including 6, 12, 18, 24, 30, 36, 42 and 48dB/Oct. For example, 12dB/Oct indicates that the attenuation range is -12dB for each octave of frequency in the transition zone.

**ON/OFF:** Switch to enable or disable the Filter modules.

### 2.3.9.8 Delay (Outputs)

The delay module applies delay to a selected output channel. Its main purpose is to adjust time alignment.

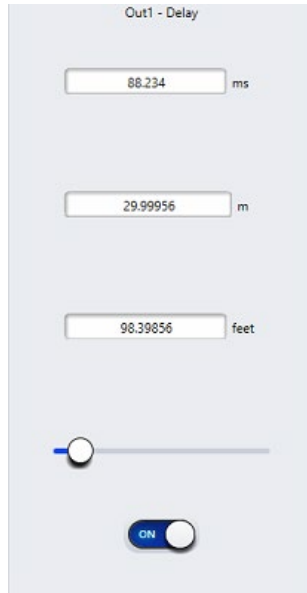

**Milliseconds, Meters and Feet:** These parameters are interlinked, they display the same delay time measured in three distinct units. Adjusting a value in any one of the parameters will automatically be converted to the other units of measure and filled in.

**Delay Slider:** Displays a graphical way to enter the delay value.

**ON/OFF:** Switch to enable or disable the Delay module.

### 2.3.9.9 Limiter (Outputs)

A Limiter is similar to a compressor but with some differences. Compression and limiting both functions similarly in that they reduce the dynamic range of an audio signal. A Compressor reduces the dynamic range of the signal at both the top and bottom, whereas a Limiter lowers the peak volume of audio by restricting the power output of the signal. A limiter is often used to protect the speakers connected on the outputs and should be configured to the instructions from the speaker manufacturer.

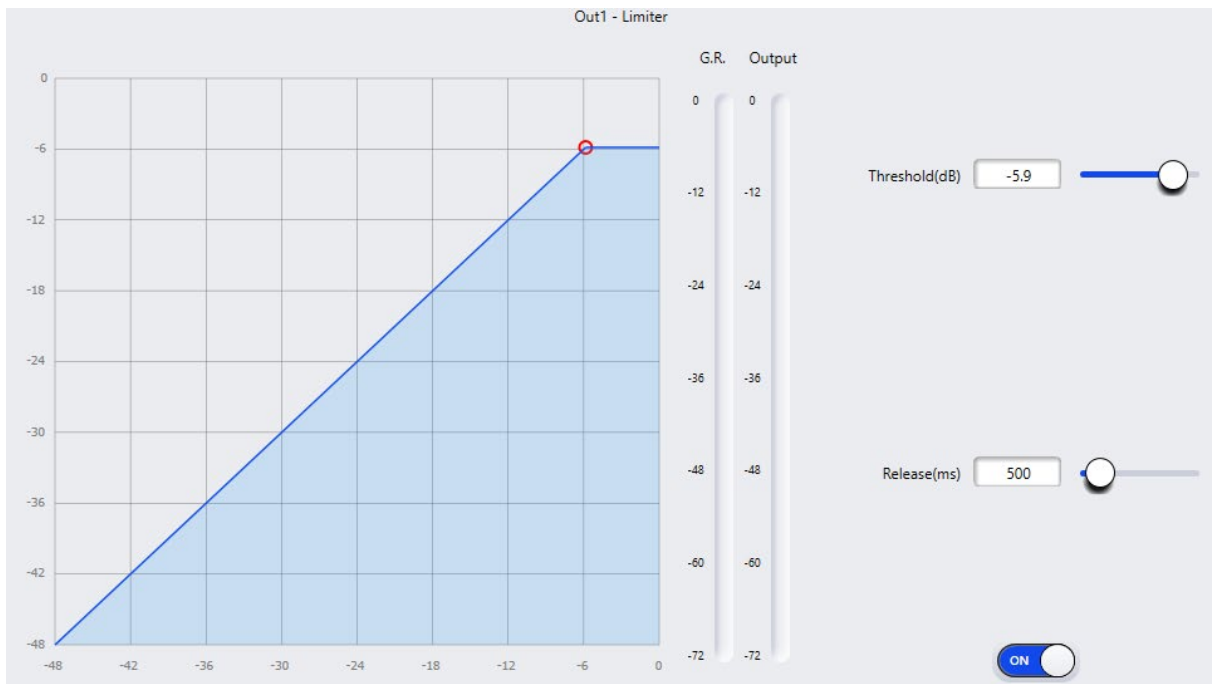

**Threshold(db):** If a signal pass above the set threshold the Limiter will be engaged.

**Attack(ms):** Attack time, sets the time for the Limiter to engage signal exceeds the set threshold. .

**Release(ms):** Release time refers to the time it takes for the Limiter to disengage after the signal falls below the set threshold.

**G.R:** Displays the amount of gain reduction applied to the signal as it passes above the set threshold.

**Output:** The fader sets the amount of gain applied to the signal after the Limiter.

**ON/OFF:** Switch to enable or disable the Limiter module.

### 2.3.9.10 Output Setting

Each output channel has phase shifting by 180 degrees and mute options.

**Phase:** Shifts the phase of the signal 180 degrees.

**Mute:** Mutes the current output channel

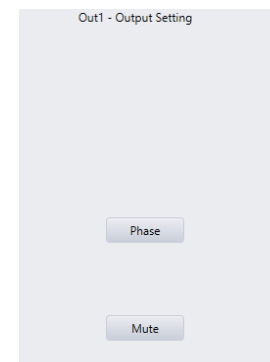

### 2.3.10 USB Soundcard

computer or MAC USB Sound Driver

By connecting a USB type A cable from the DSP to a computer, the DSP-AEC-1010 DA can be used as a sound card with a computer or MAC using generic HID audio.

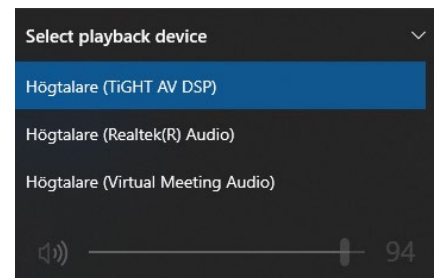

When connected to a computer via USB, the driver will appear as a "TiGHT AV DSP" in your computer settings. The USB Soundcard is built into the hardware and can be used for playback or recording. When connected to a computer, all recordings done with the DSP are stored locally on the computer, and playlists added to the player for playback are stored in the computer as well.

## 3. Control

### 3.1 External Control Programmer

External control programmer supports UDP and RS232 and controls protocols covering all controls parameters of processor, including parameter controls, parameter acquisition and preset calling.

When UDP controls are used, the default port is 50000. Ports can be set in "Device Setting" via computer software.

When using RS232 controls are used, the default baud rate is 115200, digit bits is 8, and stop bit is 1, no parity bit. Similarly, they can be set in "Device Setting". **The interval between messages shall keep more than 100ms for RS232 sending.**

If central controller needs a response, please turn on "Central Control Response" switch in "Device Setting". (See section 4.2.6 Feedback and response to SET or GET commands (V1 and V2) for more information).

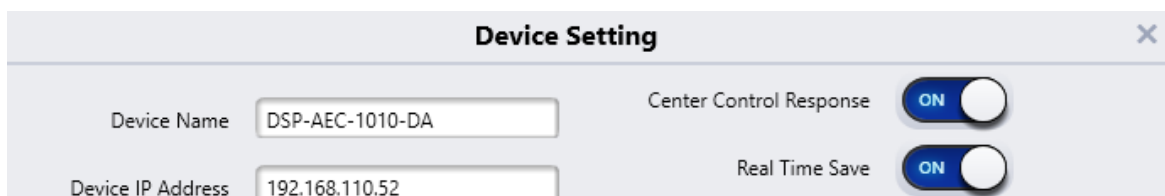

### 3.2 Control Protocol

Because of historical reasons there is two versions of control protocols V1 and V2. The latest control protocol ,V2, adopts variable-length and is fully compatible with the legacy fixed-length V1 control protocol. In the V1 and V2 protocols, the fourth byte is used to distinguish between versions. 00- indicates V1 version (previous version) and 01- indicates V2 version (current protocol version).



The difference between V1 and V2 is that V1 may control all processing module parameters, but one command can only control one parameter. If a parameter is needed to control continuous multiple channels, then V2 version should be used. Both versions are active and available for usage.

### 3.2.1 V1 Protocol Structure

Byte 1 Fixed	Byte 2	Byte 3 Fixed	Byte 4	Byte 5~12
B3	Message Type: SET = 21 GET = 22 PRESET = 13	AB	Version No: V1 = 00 V2 = 01	Data

Data Bytes 5-12: All using 2 bytes in little endian format.

Byte 5~6	Byte 7~8	Byte 9~10	Byte 11~12
Module ID	Parameter Type	Parameter 1	Parameter 2

**Byte 1** - Fixed start: B3.

**Byte 2** - Message type: SET= 21, GET =22 and PRESET =13.

**Byte 3** - Fixed to AB (can be any value but for easy programming we choose to use AB)

**Byte 4** - Version number: V1 = 00 and V2 =01.

**Byte 5-6** - Module ID: See Appendix A: Module ID.

**Byte 7-8** - Parameter type: Appendix B: Module Parameters.

**Byte 9-10** - Parameter 1.

**Byte 11-12** - Parameter 2.

Note: "Central Control Command" can acquire V1 version code through software menu bar of computer.

For customized development, please use this protocol.

### 3.2.2 V2 Protocol Structure

Byte 1 Fixed	Byte 2	Byte 3 Fixed	Byte 4	Byte 5~72
B3	Message Type:	AB	Version No: V1 = 00 V2 = 01	Data

**Byte 1** - Start of command: B3

**Byte 2** - Message types: There are various message types including:

- 21: SET.
- 22: GET, no parameter values should be filled in.
- 13: PRESET.
- 74: Other controls.

**Byte 3** – Fixed: AB

**Byte 4** - Version number: V1 = 00 and V2 = 01.

**Data bytes 5-72**

Byte 5	Byte 6	Byte 7	Byte 8	Byte 9~72
Input/Output	Start Channel	End Channel	Parameter Type	Parameter Value
Output = 01				
Input = 02				

**Byte 5** – Set control of input or output channel: 01 for output and 02 for input channels.

**Byte 6-7** - Indicate start and end channel numbers: Channel count starts at 0 (Channel 1 = 0).

**Byte 8** - Parameter type: Please refer to Appendix B.

**Byte 9-72** - Fill in parameter values of start to end channels. Each parameter value shall take two bytes.

**3.2.3 Preset Structure (V1 and V2 protocol)**

Byte 1	Byte 2	Byte 3	Byte 4	Byte 5~12
Fixed		Fixed		
B3	Message Type:	AB	Version No:	Preset No 0-15
	PRESET = 13		V1 = 00	
			V2 = 01	

**3.2.4 UDP to RS232/RS485 (V2 protocol only)**

Byte 1	Byte 2	Byte 3	Byte 4	Byte 5~72
<b>Fixed</b>		<b>Fixed</b>		
B3	Message Type:	AB	Version No:	Data
	Other = 74		V2 = 01	

Byte 5	Byte 6	Byte 7	Byte 8	Byte 9-132
Control Type:	Data Length	Reserved	Reserved	Data Bytes
RS232 = 02		00	00	
RS485 =03				

Byte 5 - Control Type: 02 = RS232, and 03= RS485.

Byte 6 - The data length of byte 6 refers to the data length in bytes that shall be sent via RS232/485.

Byte 7-8 – Reserved for future use. Fill out with 00.

Byte 9-132 - Command data to be sent via RS232/485.

### 3.2.4 RS232/RS485 to UDP (V2 protocol only)

DSP devices support RS232 translating into UDP. The protocol formats are as follows.

Byte 1	Byte 2	Byte 3	Byte 4	Byte 5~128
<b>Fixed</b>		<b>Fixed</b>		
B3	Message Type:	AB	Version No:	Data
	Other = 74		V2 = 01	

Byte 5~8	Byte 9~12	Byte 13~14	Byte 15	Byte 16	Byte 17~128
<b>Prefix</b>					
08000000	IP address of	Port Number	Data length	Reserved	Data
	receiving device				

Application scenario: The function can be applied in scenarios when a central controller has no network control ability. One of the DSPs can then be utilized as a RS232/RS485 to UDP translator and control multiple DSP or third-party devices over IP.

**Audio DSP with AEC, 4-in/4-out analog and 2x2 USB**

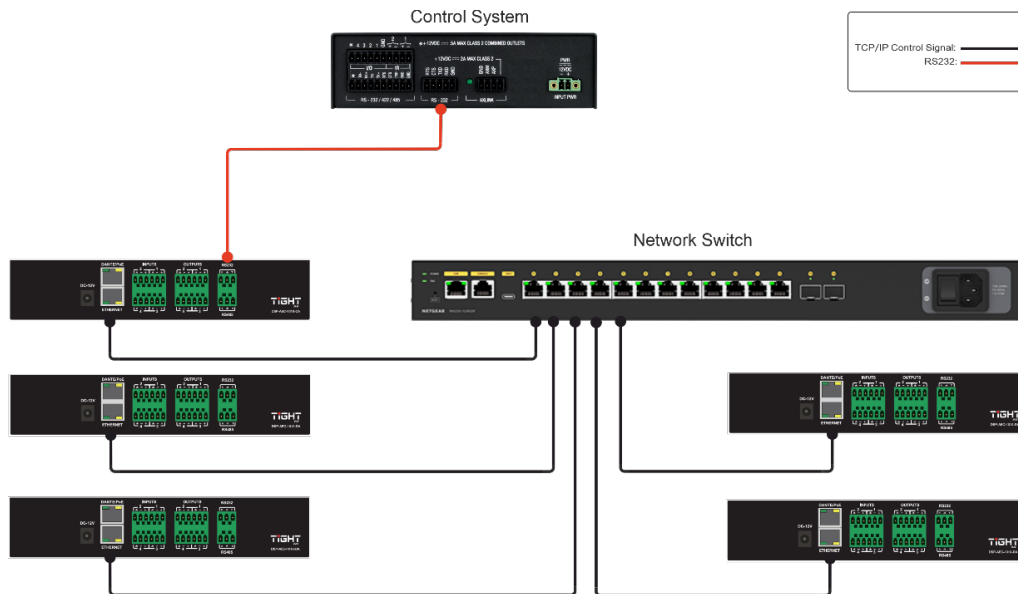

Note: Baudrate for RS232 and RS485 is set globally by software in “Device Settings”.

**3.2.5 Central Control Response control ON/OFF (V2 protocol only):**

Byte 1	Byte 2	Byte 3	Byte 4	Byte 5~9
Fixed		Fixed		
B3	Message Type:	AB	Version No:	Data
	Other = 74		V2 = 01	

Byte 5	Byte 6	Byte 7	Byte 8	Byte 9
Control Type:	Data Length	Reserved	Reserved	Data Bytes
04	01	00	00	ON = 01
				OFF = 00

**3.2.6 Feedback and response to SET or GET commands (V1 and V2)**

Response to a SET command will mirror the sent command with the exception of Byte 4 (Version No) where the response will have “E0” for V1 and “E1” for V2.

Response to a GET command will have Byte 4 (Version No) “E0” for V1 and “E1” for V2 and the Parameters filled in with the requested status information.

### 3.3 Appendix A: Module ID

<b>Module:</b>	<b>ID</b>
<b>Input Source</b>	299
<b>Input Channel 1-32 - 1<sup>st</sup> module (Expander)</b>	1~32
<b>Input Channel 1-32 - 2<sup>nd</sup> module (Compressor)</b>	33~64
<b>Input Channel 1-32 - 3<sup>rd</sup> module (AGC)</b>	65~95
<b>Input Channel 1-32 - 4<sup>th</sup> module (PEQ (8))</b>	97~128
<b>Input Channel 1-32 - 5<sup>th</sup> module (AFS)</b>	129~160
<b>AutoMixer</b>	161
<b>Aucoustic Echo Cancellation AEC 1</b>	163
<b>Aucoustic Echo Cancellation AEC 2</b>	301
<b>AEC Matrix</b>	162
<b>Automatic Noise Suppression (ANS)</b>	165
<b>ANS Channel Selector</b>	164
<b>Matrix</b>	166
<b>Output</b>	295
<b>System Control</b>	296
<b>Output Channel 1-32 Filter</b>	167~198
<b>Output Channel 1-32 Equalizer</b>	199~230
<b>Output Channel 1-32 Delay</b>	231~262
<b>Output Channel 1-32 Limiter</b>	263~294

### 3.4 Appendix B: Module Parameters

Module:	Type	Description	Parameter 1 (Value)	Parameter 2 (Value)
<b>Input</b>	1	Gain	Input channel 1 ~ 10 => Values: 0 ~ 9	(-)72dB to 12dB in steps of 0,01dB => Values: -7200 ~ 1200
	2	Mute	Input channel 1 ~ 10 => Values: 0 ~ 9	ON = 1 OFF=0
	3	Sensitivity	Input channel 1 ~ 10 => Values: 0 ~ 9	0dB to 48dB in 6dB steps => Values: 0~8
	4	Phantom Power Switch	Input channel 1 ~ 10 => Values: 0 ~ 9	ON = 1 OFF=0
	5	Signal Generator	Input channel 1 ~ 10 => Values: 0 ~ 9	OFF (Analog signal)=0 Sine =1 White=2 Pink=3
	6	Signal Generator Frequency	Input channel 1 ~ 10 => Values: 0 ~ 9	20Hz to 20 000Hz in steps of 1Hz => Values 20 ~ 20 000
	7	Level (dBFS)	Input channel 1 ~ 10 => Values: 0 ~ 9	(-)72dBFS to 0dBFS in steps of 0,01dBFS => Values -7200 ~ 0
	8	Channel Name	Input channel 1 ~ 10 => Values: 0 ~ 9	SET: Only supporting 2 bytes GET: Fill out command past 12th byte with 00 to get full name
	9	Invert Phase	Input channel 1 ~ 10 => Values: 0 ~ 9	ON = 1 OFF= 0
	10	Increase/decrease Gain by step	Input channel 1 ~ 10 => Values: 0 ~ 9	+3dB = 300 +2dB = 200 +1dB = 100 -1dB = -100 -2dB = -200 -3dB = -300

	11	Link	Link CH1 and CH2 = 1 Link CH3 and CH4 = 3 Link CH5 and CH6 = 5 Link CH7 and CH8 = 7 Link CH9 and CH10 = 9	ON = 1 OFF= 0
	12	Channel Level (Meter)	Input channel 1 ~ 8 => Values: 0 ~ 7	
<b>Delay</b>	1	Global Switch	ON = 0 OFF=1	
	2	In Milliseconds	0ms to 1200ms in steps of 1ms => Values 0 ~ 1200	
<b>PEQ</b>	1	Total Equalizer Switch	ON = 0 OFF=1	
	2	Child Segment Switch	8 Bands => Values: 0 ~ 7	ON = 0 OFF=1
	3	Frequency	8 Bands => Values: 0 ~ 7	20Hz to 20 000Hz in steps of 1Hz => Values 20 ~ 20 000
	4	Gain	8 Bands => Values: 0 ~ 7	(-)24dB to 18dB in steps of 0,01dB => Values: -2400 ~ 1800
	5	Q Value	8 Bands => Values: 0 ~ 7	0,02 to 50 in steps of 0,01 => Values 2 ~ 5000
	6	Type	8 Bands => Values: 0 ~ 7	Low pass = 0 High pass = 1 Parametric = 6 Lowshelf = 7 Highshelf = 8
<b>Output</b>	1	Gain	Output channel 1 ~ 10 => Values: 0 ~ 9	(-)72dB to 12dB in steps of 0,01dB => Values: -7200 ~ 1200
	2	Mute	Output channel 1 ~ 10 => Values: 0 ~ 9	ON = 1 OFF= 0

	3	Channel Name	Output channel 1 ~ 10 => Values: 0 ~ 9	SET: Only supporting 2 bytes GET: Fill out command past 12th byte with 00 to get full name
	4	Invert Phase	Output channel 1 ~ 10 => Values: 0 ~ 9	ON = 1 OFF= 0
	6	Increase/decrease by step	Output channel 1 ~ 10 => Values: 0 ~ 9	+3dB = 300 +2dB = 200 +1dB = 100 -1dB = -100 -2dB = -200 -3dB = -300
	7	Link	Link CH1 and CH2 = 1 Link CH3 and CH4 = 3 Link CH5 and CH6 = 5 Link CH7 and CH8 = 7 Link CH9 and CH10 = 9	ON = 1 OFF= 0
	8	Channel Level (Meter)	Output channel 1 ~ 10 => Values: 0 ~ 9	Only available as GET command (-)72dB to 0dB in steps of 0,01dB => Values: -7200 ~ 0
<b>Expander</b>	1	Global Switch	ON = 0 OFF=1	
	2	Threshold (dB)	(-)72dB to 0dB in steps of 0,01dB => Values -7200 ~ 0	
	3	Ratio	1dB to 20dB in steps of 0,01dB => Values 100 ~ 2000	
	4	Attack Time (ms)	1ms to 500ms in steps of 1ms => Values 1 ~ 500	



	5	Release Time (ms)	1ms to 10 000ms in steps of 1ms => Values 1 ~ 10 000	
<b>Compressor</b>	1	Global Switch	ON = 0 OFF=1	
	2	Compressor Threshold (dB)	(-)48dB to 0dB in steps of 0,01dB => Values -4800 ~ 0	
	3	Compressor Ratio	1dB to 20dB in steps of 0,01dB => Values 100 ~ 2000	
	4	Attack Time (ms)	1ms to 500ms in steps of 1ms => Values 1 ~ 500	
	5	Release Time (ms)	1ms to 10 000ms in steps of 1ms => Values 1 ~ 10 000	
	6	Gain Compensation (dB)	(-)72dB to 6dB in steps of 0,01dB => Values -7200 ~ 600	
<b>Matrix</b>	1	Matrix Switch	First byte input ch 0 ~ 13 Second byte output ch 0 ~ 9 Ex IN1 OUT4=> 00 03	ON = 1 OFF= 0
	2	Matrix Gain	First byte input ch 0 ~ 13 Second byte output ch 0 ~ 9 Ex IN1 OUT4=> 00 03	(-)72dB to 12dB in steps of 0,01dB => Values: -7200 ~ 1200
<b>Filter</b>	1	High Pass Switch	ON = 0 OFF= 1	
	2	High Pass Type	Bessel = 0 Butterworth = 1 Likwitz-Riley = 2	
	3	High Pass Slope	Values: 6, 12, 18, 24, 30, 36, 42 and 48	

Audio DSP with AEC, 4-in/4-out analog and 2x2 USB

	4	High Pass Frequency	20Hz to 20 000Hz in steps of 1Hz => Values: 20 ~ 20 000	
	5	High Pass Gain	(-)15dB to 15dB in steps of 0,01dB => Values: -1500 ~ 1500	
	11	Low Pass Switch	ON = 0 OFF= 1	
	12	Low Pass Type	Bessel = 0 Butterworth = 1 Likwitz-Riley = 2	
	13	Low Pass Slope	Values: 6, 12, 18, 24, 30, 36, 42 and 48	
	14	Low Pass Frequency	20Hz to 20 000Hz in steps of 1Hz => Values: 20 ~ 20 000	
	15	Low Pass Gain	(-)15dB to 15dB in steps of 0,01dB => Values: -1500 ~ 1500	
<b>Auto Mixer</b>	1	Global Switch	ON = 0 OFF= 1	
	2	Global Gain (dB)	(-)72dB to 12dB in steps of 0,01dB => Values: -7200 ~ 1200	
	3	Slope	1 to 3 in 0,01 steps => Value: 100 ~ 300	
	4	Response Time	5ms to 5 000ms in steps of 1ms => Values: 5 ~ 5 000	
	5	Channel Auto Mixer	Channel 1 ~ 8 => Values: 0 ~ 7	ON = 1 OFF= 0
	6	Channel Mute	Channel 1 ~ 8 => Values: 0 ~ 7	ON = 1 OFF= 0

	7	Channel Gain	Channel 1 ~ 8 => Values: 0 ~ 7	(-)72dB to 12dB in steps of 0,01dB => Values: -7200 ~ 1200
	8	Priority	Channel 1 ~ 8 => Values: 0 ~ 7	Values: 1 ~ 10
	9	Auto Mix Switch	ON = 0 OFF=1	
<b>Automatic Feedback Suppression (AFS)</b>	1	Global Switch	ON = 0 OFF=1	
	2	Feedback Point Frequency (Hz)	Freq 1 ~ 8 => Values: 0 ~ 7	20Hz to 20 000Hz in steps of 1Hz => Values 20 ~ 20 000
	3	Feedback Point Gain (dB)	Freq 1 ~ 8 => Values: 0 ~ 7	(-)24dB to 0dB in steps of 0,01dB => Values: -2400 ~ 0
	4	Octave Value	1/5 Octave = 20 1/10 Octave = 10	
	5	Type	Freq 1 ~ 8 => Values: 0 ~ 7	Dynamic = 0 Fixed = 1 Manual = 2
	8	Panic Threshold (dB)	(-)36dB to 0dB in steps of 0,01dB => Values: -3600 ~ 0	
	9	Feedback Threshold (dB)	(-)96dB to -24dB in steps of 0,01dB => Values: -9600 ~ - 2400	
<b>Auto Gain Compensation (AGC)</b>	1	Global Switch	ON = 0 OFF=1	
	2	Threshold (dB)	(-)72dB to -20dB in steps of 0,01dB => Values -7200 ~ - 2000	

**Audio DSP with AEC, 4-in/4-out analog and 2x2 USB**

	3	Target Level (dB)	(-)40dB to 0dB in steps of 0,01dB => Values -4000 ~ 0	
	4	Ratio	1dB to 20dB in steps of 0,01dB => Values 100 ~ 2000	
	5	Attack Time (ms)	1ms to 500ms in steps of 1ms => Values 1 ~ 500	
	6	Release Time (ms)	1ms to 10 000ms in steps of 1ms => Values 1 ~ 10 000	
<b>AEC</b>	1	Global Switch	ON = 0 OFF=1	
	2	Echo Cancellation Mode	Conservative (128ms) = 0 Moderate (256ms) = 1 Aggressive (512ms) = 2	
<b>AEC Matrix</b>	1	AEC Channel	Local Input AEC1 CH 1 = 0 CH 2 = 1 CH 3 = 2 CH 4 = 3 CH 5 = 4 CH 6 = 5 CH 7 = 6 CH 8 = 7 AutoMixer = 10  Rem. Input AEC1 CH 1 = 256 CH 2 = 257 CH 3 = 258 CH 4 = 259 CH 5 = 260 CH 6 = 261 CH 7 = 262 CH 8 = 263 USBL = 264 USBR = 265	ON = 1 OFF=0

			Local Input AEC2 CH 1 = 512 CH 2 = 513 CH 3 = 514 CH 4 = 515 CH 5 = 516 CH 6 = 517 CH 7 = 518 CH 8 = 519 AutoMixer = 522  Rem. Input AEC2 CH 1 = 768 CH 2 = 769 CH 3 = 770 CH 4 = 771 CH 5 = 772 CH 6 = 773 CH 7 = 774 CH8 = 775 USBL = 776 USBR = 777	
<b>Automatic Noise Suppression (ANS)</b>	1	ANS Switch	ON = 0 OFF=1	
	2	ANS Level (dB)	6dB = 0 10dB = 1 15dB = 2 18dB = 3	
<b>ANS Channel</b>	1	Channel	Channel Values: 0 ~ 13	ON = 1 OFF=0
<b>System Control</b>	2	System Mute	ON = 1 OFF=0	
<b>Limiter</b>	1	Limiter Switch	ON = 0 OFF=1	
	2	Limiter Threshold (dB)	(-)48dB to 0dB in steps of 0,01dB => Values -4800 ~ 0	
	5	Release Time (ms)	1ms to 10 000ms in steps of 1ms => Values 1 ~ 10 000	

### 3.5 Appendix C, Command Structure Examples

#### 3.5.1 V1 examples

##### SET examples

<b>1. Set input Gain to -3dB for input 4.</b>		
<b>Structure</b>	<b>Command</b>	<b>Comments</b>
Byte 1 : Fixed start B3	B3	Fixed
Byte 2: Message type: SET= 21, GET =22 and PRESET =13	21	SET
Byte 3: Fixed to AB	AB	Fixed
Byte 4: Version number: V1 = 00 and V2 =01.	00	Version 1
Byte 5-6: Module ID: See Appendix A: Module ID in manual.	2B 01	Appendix A, Input source ID = 299 gets 2B 01 in little endian format
Byte 7-8: Parameter type: Appendix B: Module Parameter Types (1).	01 00	Appendix B Input source Gain = 1 gets 01 00 in little endian format
Byte 9-10: Parameter 1	03 00	Inputs starts counting at 0 = input 1 so input 4 gets value 3 and in little endian 03 00
Byte 11-12: Parameter 2	D4 FE	(-)3db in hundreds gets value -300 which corresponds to D4 FE in little endian format.
SET command: B3 21 AB 00 2B 01 01 00 03 00 D4 FE		Response: B3 21 AB <b>E0</b> 2B 01 01 03 00 00 D4 FE

<b>1. Increase Gain +3dB for input 2.</b>		
<b>Structure</b>	<b>Command</b>	<b>Comments</b>
Byte 1 : Fixed start B3	B3	Fixed
Byte 2: Message type: SET= 21, GET =22 and PRESET =13	21	SET
Byte 3: Fixed to AB	AB	Fixed
Byte 4: Version number: V1 = 00 and V2 =01.	00	Version 1
Byte 5-6: Module ID: See Appendix A: Module ID in manual.	2B 01	Appendix A, Input source ID = 299 gets 2B 01 in little endian format

Byte 7-8: Parameter type: Appendix B: Module Parameter Types (1).	0A 00	Appendix B Input source Gain = 10 gets 0A 00 in little endian format
Byte 9-10: Parameter 1	01 00	Inputs starts counting at 0 = input 1 so input 2 gets value 1 and in little endian 01 00
Byte 11-12: Parameter 2	2C 01	(+3db in hundreds gets value 300 which corresponds to 2C 01 in little endian format.
SET command: B3 21 AB 00 2B 01 0A 00 01 00 2C 01	Response: B3 21 AB <b>E0</b> 2B 01 0A 00 01 00 2C 01	

<b>2. Set Input 8 to Mute.</b>		
<b>Structure</b>	<b>Command</b>	<b>Comments</b>
Byte 1 : Fixed start B3	B3	Fixed
Byte 2: Message type: SET= 21, GET =22 and PRESET =13	21	SET
Byte 3: Fixed to AB	AB	Fixed
Byte 4: Version number: V1 = 00 and V2 =01.	00	Version 1
Byte 5-6: Module ID: See Appendix A: Module ID in manual.	2B 01	Appendix A, Input source ID = 299 gets 2B 01 in little endian format
Byte 7-8: Parameter type: Appendix B: Module Parameter Types (1).	02 00	Appendix B Input source Mute = 2 gets 02 00 in little endian format
Byte 9-10: Parameter 1	07 00	Inputs starts counting at 0 = input 1 so input 8 gets value 7 and in little endian 07 00
Byte 11-12: Parameter 2	01 00	Mute On = 1 which corresponds to 01 00 in little endian format.
SET command: B3 21 AB 00 2B 01 02 00 07 00 01 00	Response: B3 21 AB <b>E0</b> 2B 01 02 00 07 00 01 00	

<b>3. Set AEC Switch 1 to ON</b>		
<b>Structure</b>	<b>Command</b>	<b>Comments</b>
Byte 1 : Fixed start B3	B3	Fixed
Byte 2: Message type: SET= 21, GET =22 and PRESET =13	21	SET

Byte 3: Fixed to AB	AB	Fixed
Byte 4: Version number: V1 = 00 and V2 =01.	00	Version 1
Byte 5-6: Module ID: See Appendix A: Module ID in manual.	A3 00	Appendix A, Echo Cancellation = 163 gets A3 00 in little endian format
Byte 7-8: Parameter type: Appendix B: Module Parameter Types (1).	01 00	Appendix B Echo Cancellation Switch = 1 gets 01 00 in little endian format
Byte 9-10: Parameter 1	00 00	Value 0 = AEC on which corresponds to 00 00 in little endian format.
Byte 11-12: Parameter 2	00 00	Fill up with 00 00
SET command: B3 21 AB 00 A3 00 01 00 00 00 00 00	Response: B3 21 AB <b>E0</b> A3 00 01 00 00 00 00 00	

### GET examples

<b>1. Get Input Gain for input 2</b>		
<b>Structure</b>	<b>Command</b>	<b>Comments</b>
Byte 1 : Fixed start B3	B3	Fixed
Byte 2: Message type: SET= 21, GET =22 and PRESET =13	22	GET
Byte 3: Fixed to AB	AB	Fixed
Byte 4: Version number: V1 = 00 and V2 =01.	00	Version 1
Byte 5-6: Module ID: See Appendix A: Module ID in manual.	2B 01	Appendix A, Input source ID = 299 gets 2B 01 in little endian format
Byte 7-8: Parameter type: Appendix B: Module Parameter Types (1).	01 00	Appendix B Input source Gain = 1 gets 01 00 in little endian format
Byte 9-10: Parameter 1	01 00	Inputs starts counting at 0 = input 1 so input 2 gets value 1 and in little endian 01 00
Byte 11-12: Parameter 2	00 00	Fill up with 00 00
GET command: B3 22 AB 00 2B 01 01 00 01 00 00 00	Response: B3 23 AB <b>E0</b> 2B 01 01 00 01 00 <b>24 FF</b> (24 FF = -220 => -2,2dB)	

<b>2. Get Mute status for output 5</b>		
<b>Structure</b>	<b>Command</b>	<b>Comments</b>
Byte 1 : Fixed start B3	B3	Fixed



Byte 2: Message type: SET= 21, GET =22 and PRESET =13	22	GET
Byte 3: Fixed to AB	AB	Fixed
Byte 4: Version number: V1 = 00 and V2 =01.	00	Version 1
Byte 5-6: Module ID: See Appendix A: Module ID in manual.	27 01	Appendix A, Output ID = 295 gets 27 01 in little endian format
Byte 7-8: Parameter type: Appendix B: Module Parameter Types (1).	02 00	Appendix B Output Mute = 2 gets 02 00 in little endian format
Byte 9-10: Parameter 1	04 00	Inputs starts counting at 0 = output 1 so output 5 gets value 4 and in little endian 04 00
Byte 11-12: Parameter 2	00 00	Fill up with 00 00
GET command: B3 22 AB 00 27 01 02 00 04 00 00 00		Response: B3 21 AB <b>E0</b> 27 01 02 00 04 00 <b>01</b> 00 (01 00 = Mute On)

### PRESET example

<b>1. Get Input Gain for input 2</b>		
<b>Structure</b>	<b>Command</b>	<b>Comments</b>
Byte 1 : Fixed start B3	B3	Fixed
Byte 2: Message type: SET= 21, GET =22 and PRESET =13	13	PRESET
Byte 3: Fixed to AB	AB	Fixed
Byte 4: Version number: V1 = 00 and V2 =01.	00	Version 1
Byte 5-6: Preset number 1-16	02 00	Preset 3 is then value 3 which corresponds to 02 00 in little endian format.
Byte 7-8: Not used	00 00	Fill up with 00 00
Byte 9-10: Not used	00 00	Fill up with 00 00
Byte 11-12: Not used	00 00	Fill up with 00 00
PRESET command: B3 13 AB 00 02 00 00 00 00 00 00 00		Response: B3 13 AB <b>E0</b> 02 00 00 00 00 00 00 00

### 3.5.2 V2 examples

#### SET example:

1. SET Input Mute CH1-CH4		
Structure	Command	Comments
Byte 1 : Fixed start B3	B3	Fixed
Byte 2: Message type: SET= 21, GET =22 and PRESET =13	21	SET
Byte 3: Fixed to AB (any will actually do but we set it to AB)	AB	Fixed
Byte 4: Version number: V1 = 00 and V2 =01.	01	Version 2
Byte 5: Input or Output	02	Input = 02
Byte 6: Start Channel	00	CH1 = 00
Byte 7: End Channel	03	CH4 = 03
Byte 8: Parameter type	02	Input Mute = 02
Byte 9: Parameter value	01	Mute = 01
SER command: B3 21 AB 01 02 00 03 02 01		Response: B3 21 AB <b>E1</b> 02 00 03 02 01

#### GET example:

1. GET output Gain CH2-CH5		
Structure	Command	Comments
Byte 1 : Fixed start B3	B3	Fixed
Byte 2: Message type: SET= 21, GET =22 and PRESET =13	22	PRESET
Byte 3: Fixed to AB (any will actually do but we set it to AB)	AB	Fixed
Byte 4: Version number: V1 = 00 and V2 =01.	01	Version 2
Byte 5: Input or Output	01	Output = 01
Byte 6: Start Channel	01	CH2 = 01
Byte 7: End Channel	05	CH5 = 04
Byte 8: Parameter type	01	Input Gain = 01
Byte 9: Parameter value	01	Fill up with: 00 00 00 00 00 00 00 00
GET command: B3 22 AB 01 01 01 04 01 00 00 00 00 00 00 00 00		Response: B3 22 AB <b>E1</b> 01 01 04 01 <b>C8 00 18 FC 18 FC 50 FB</b> CH2 = C8 00 (little endian) = 200 > Gain = 2dB

	CH2 = 18 FC (little endian) = -1000 > Gain = -10dB CH2 = 18 FC (little endian) = -1000 > Gain = -10dB CH2 = 50 FB (little endian) = -1200 > Gain = -12dB
--	--

**RS232 to UDP example:**

<b>1. Send command "HELLO DSP" to 192.168.40.159 on UDP port 50 000.</b>		
<b>Structure</b>	<b>Command</b>	<b>Comments</b>
Byte 1 : Fixed start B3	B3	Fixed
Byte 2: Message type: SET= 21, GET =22 and PRESET =13	74	Other controls
Byte 3: Fixed to AB (any will actually do but we set it to AB)	AB	Fixed
Byte 4: Version number: V1 = 00 and V2 =01.	01	Version 2
Byte 5~8: Prefix	08 00 00 00	Prefix =08 00 00 00
Byte 9~12: IP address of receiving device	C0 A8 28 9F	192.168.40.159 = C0 A8 28 9F
Byte 13~14: Port number	50 C3	50 000 = 50 C3
Byte 15: Data length	09	9 Bytes = 09
Byte 16: Reserved	00	00
Byte 17~128: Data	48 45 4C 4C 4F 20 44 53 50	"HELLO DSP" = 48 45 4C 4C 4F 20 44 53 50
Command: B3 74 AB 01 08 00 00 00 C0 A8 28 9F 50 C3 09 00 48 45 4C 4C 4F 20 44 53 50	Response: B3 74 AB <b>E1</b> 08 00 00 00 C0 A8 28 9F 50 C3 09 00 48 45 4C 4C 4F 20 44 53 50	

## 4. Environment and recycle information

### 4.1 Disposal of electric and electronic devices EC Directive



#### 2012/19/EU

This product is not to be treated as regular household waste but must be returned to a collection point for recycling electric and electronic devices. Further information is available from your municipality, your municipality's waste disposal services, or the retailer where you purchased your product.

### 4.2 Packaging recycling information

	SCATOLA CORRUGATED PAPER BOX	RACCOLTA CARTA MIXED PAPER AND CARD
	BUSTA PER CAVO CABLE BAG	RACCOLTA PLASTICA PLASTICS
	BUSTA PER DEVICE DEVICE BAG	RACCOLTA PLASTICA PLASTICS
	BUSTA PER CONNETTORI TERMINAL BLOCK BAG	RACCOLTA PLASTICA PLASTICS
	SCHIUMA EPE PACKING FOAM	RACCOLTA PLASTICA PLASTICS

*Verifica le disposizioni del tuo comune  
Check the regulations of your municipality*

Note: This manual is recycled as paper (mixed paper and card).

