



User Manual

MSW-H614A-HDBT

6x4+2 18G HDMI 2.0 Matrix Switcher with HDBT

All Rights Reserved

Version: MSW-H614A-HDBT_2023V1.0

Preface

Read this user manual carefully before using the product. Pictures shown in this manual are for reference only. Different models and specifications are subject to real product.

This manual is only for operation instruction, please contact the local distributor for maintenance assistance. The functions described in this version were updated till June, 2023. In the constant effort to improve the product, we reserve the right to make functions or parameters changes without notice or obligation. Please refer to the dealers for the latest details.

FCC Statement

This equipment generates, uses and can radiate radio frequency energy and, if not installed and used in accordance with the instructions, may cause harmful interference to radio communications. It has been tested and found to comply with the limits for a Class B digital device, pursuant to part 15 of the FCC Rules. These limits are designed to provide reasonable protection against harmful interference in a commercial installation.

Operation of this equipment in a residential area is likely to cause interference, in which case the user at their own expense will be required to take whatever measures may be necessary to correct the interference.

Any changes or modifications not expressly approved by the manufacture would void the user's authority to operate the equipment.



SAFETY PRECAUTIONS

To ensure the best from the product, please read all instructions carefully before using the device. Save this manual for further reference.

- Unpack the equipment carefully and save the original box and packing material for possible future shipment.
- Follow basic safety precautions to reduce the risk of fire, electrical shock and injury to persons.
- Do not dismantle the housing or modify the module. It may result in electrical shock or burn.
- Using supplies or parts not meeting the specifications of product may cause damage, deterioration or malfunction.
- Refer all servicing to qualified service personnel.
- To prevent fire or shock hazard, do not expose the unit to rain, moisture or install this product near water.
- Do not put any heavy items on the extension cable in case of extrusion.
- Do not remove the housing of the device as opening or removing housing may expose you to dangerous voltage or other hazards.
- Install the device in a place with fine ventilation to avoid damage caused by overheat.
- Keep the module away from liquids.
- Spillage into the housing may result in fire, electrical shock, or equipment damage. If an object or liquid falls or spills on to the housing, unplug the module immediately.
- Do not twist or pull by force ends of the optical cable. It can cause malfunction.
- Do not use liquid or aerosol cleaners to clean this unit. Always unplug the power to the device before cleaning.
- Unplug the power cord when left unused for a long period of time.
- Information on disposal for scrapped devices: do not burn or mix with general household waste, and please treat them as normal electrical wastes.

Table of Contents

1. Product Introduction	1
1.1 Key Features	1
1.2 Package List	2
1.3 Customer Service	2
2. Technical Specification	3
3. Panel Descriptions	5
3.1 Front Panel	5
3.2 Rear Panel	6
4. System Connection	7
4.1 Usage Precaution	7
4.2 System Diagram	7
5. Front Panel Control	8
5.1 Signal switching	8
5.2 Current routing status	9
5.3 Front Panel Lock/Unlock	9
5.4 Audio Settings	10
5.5 Preset Save/Recall Function	11
5.6 IP Address Inquiry	12
5.7 Switch IP Mode using Front Panel	12
6. GUI Control	13
6.1 AV Routing	14
6.2 I/O Configuration	16
6.3 Device Settings	18
6.4 CEC	20
6.5 Control	21
7. IR Control	23
8. Device Control	24
8.1 RS232	24
8.2 TCP/IP Control	24
8.3 Command Protocol	25

6x4+2 18G HDMI 2.0 Matrix Switcher with HDBT

8.3.1 Device Settings	25
8.3.2 AV Routing	28
8.3.3 Audio Settings	29
8.3.4 HDCP Management	31
8.3.5 EDID Management	33
8.3.6 Function Settings	36
8.3.7 CEC Table	47
9. Firmware Upgrade	50
9.1 MCU upgrade by USB	50
9.2 MCU upgrade by Web UI	50
9.3 GUI Upgrade	51
10. Drawings and Dimensions	52
11. Environment and recycling information	52
11.1 Disposal of electric and electronic devices EC Directive 2012/19/EU	52
11.2 Packaging recycling information	53

6x4+2 18G HDMI 2.0 Matrix Switcher with HDBT

1. Product Introduction

The MSW-H614A-HDBT is a professional 6x4+2 18Gbps HDMI 2.0 Matrix Switcher with Audio Matrix. The Matrix features 2 HDBaseT inputs, 4 HDMI inputs, 4 HDMI outputs with 2 mirrored HDBaseT outputs. Each of the HDMI outputs and each of the HDBaseT outputs are designed with auto-downscaling 4K to 1080p. It also features 4 SPDIF and 4 analogue audio outputs for audio matrix.

The matrix switcher features comprehensive EDID management and advanced HDCP handling to ensure maximum functionality with a wide range of video sources and displays. The matrix switcher also offers multiple control options by front panel, IR, RS232 commands, WEB UI and TCP/IP commands.

1.1 Key Features

- Supports HDMI 2.0b, 4K@60Hz 4:4:4, HDR 10, Dolby Vision and HDCP 2.3.
- Equipped with HDBaseT inputs and outputs for signal extension. Compatible with TiGHT AV EXT-H101L2-TX/RX-HDBT and EXT-H211L2-SRX-HDBT.
- Max transmission is up to 4K 40m and 1080p@70m over HDBT.
- Audio matrix, audio out can de-embedded from arbitrary input or output.
- Individual volume adjustment and delay on each analog audio output.
- Supports 4K to 1080p auto-downscaling without frame rate change on all HDMI and HDBaseT outputs.
- Provides 24V PoC for compatible TiGHT AV HDBaseT transmitters and receivers.
- Each of the HDMI outputs supports up to 5V@500mA for AoC cables.
- WEB-UI for control and configuration.
- Extensive HDCP and EDID management.
- Controllable by front panel, IR, RS232 and TCP/IP.
- Open TiGHT AV API for third-party control.

6x4+2 18G HDMI 2.0 Matrix Switcher with HDBT

1.2 Package List

- 1x MSW-H614A-HDBT Matrix Switcher
- 2x Mounting Ears with 6 Screws
- 4x Plastic Cushions
- 1x IR Receiver
- 1x IR Remote
- 1x RS232 Cable (3-pin to DB9)
- 4x 5-pin Terminal Blocks
- 1x EU Power Cord
- 1x UK Power Cord
- 1x User Manual

Note: Please contact your distributor immediately if any damage or defect in the components is found.

1.3 Customer Service

TiGHT AV provide limited warranty for the product within **five years** counting from date of purchase (The purchase invoice shall prevail).

For more information see TiGHT AV general Warranty Statement at <https://tightav.com/warranty-statement> or just scan the QR-code below.



6x4+2 18G HDMI 2.0 Matrix Switcher with HDBT

2. Technical Specification

Video	
Video Input	(4) HDMI, (2) HDBT
Input Connector	(4) Type-A female HDMI, (2) RJ45
HDMI Input Resolution	Up to 4K@60Hz 4:4:4, HDR10, Dolby Vision
Video Output	(4) HDMI, (2) mirrored HDBT
Output Connector	(4) Type-A female HDMI, (2) RJ45
HDMI Output Resolution	Up to 4K@60Hz 4:4:4, HDR10, 1080p 3D. Supports 4K to 1080p auto-downscaling.
HDBaseT Output Resolution	Up to 4K@60Hz 4:4:4 (using compatible receivers)
HDMI Standard	HDMI 2.0b
HDCP Version	HDCP 2.x/1.x
Audio	
HDMI Embedded Audio Format	LPCM 7.1 audio, Dolby Atmos®, Dolby® TrueHD, Dolby Digital® Plus, DTS:X™, and DTS-HD® Master Audio™ pass-through.
Audio Output	(4) Stereo analog L+R audio, (4) Digital SPDIF audio
Output Connector	(4) 5-pin terminal blocks, (4) Toslink connectors
Analog L+R Audio Format	Supports PCM
Digital SPDIF Audio Format	Supports PCM, Dolby Digital, DTS, DTS-HD
Local Audio Sampling Rate	Supports 44.1KHz, 48KHz, 96KHz
Frequency Response	20Hz – 20KHz, ±3dB
Audio Output Impedance	70Ω
Max Input Level	L+R: 2.0Vrms ± 0.5dB. 2V = 16dB headroom above -10dBV (316mV) nominal consumer line level signal. SPDIF: ±0.05dBFS.
THD+N	< 0.05% (-80dB), 20Hz – 20KHz bandwidth, 1KHz sine at 0dBFS level (or max level).
SNR	L+R: > 80dB, 20Hz - 20KHz bandwidth. SPDIF: > 90dB, 20Hz - 20 kHz bandwidth.
Crosstalk Isolation	SPDIF: < -120 dB, 10KHz sine at 0dBFS level (or max level before clipping). L+R: < -60 dB, 10KHz sine at 0dBFS level (or max level before clipping).
L-R Level Deviation	L+R: < 0.3dB, 1KHz sine at 0dBFS level (or max level before clipping).
Frequency Response Deviation	< ± 0.5dB 20Hz - 20KHz.
Output Load Capability	L+R: 1KΩ and higher (Supports 10x paralleled 10KΩ loads).
Control	

6x4+2 18G HDMI 2.0 Matrix Switcher with HDBT

Control port	(1) IR EYE, (1) RS232, (1) TCP/IP
Control Connector	(1) 3.5mm jacks, (1) 3-pin terminal blocks, (1) RJ45
General	
Extension Transmission Mode	HDBaseT
Transmission Distance	1080p ≤ 230 feet (70 meters), 4K@60Hz ≤ 131 feet (40 meters)
Bandwidth	Up to 18Gbps
Operation Temperature	-5°C ~ +55°C
Storage Temperature	-25°C ~ +70°C
Relative Humidity	10% ~ 90%
Power Consumption	115W Max (Fully loaded and powering TX and RX)
External Power Supply	100V~240V AC, 50/60Hz
Dimension (W*H*D)	435mm x 43mm x 300mm
Net Weight	3.40kg
Shipping Dimension (W*H*D)	505mm x 140mm x 365mm
Shipping Weight	5.30kg
Compliance	FCC, CE
Environmental	RoHS, REACH, WEEE

3. Panel Descriptions

3.1 Front Panel



- ① **FW:** Micro-USB port for firmware upgrade.
- ② **LCD Screen:** Presents real-time operation status and configuration.
- ③ **PWR:** Illuminates red when the device is in standby mode, illuminates green when device is powered on.
- ④ **IR:** Built-in IR sensor receives an IR signal from the IR remote to control the matrix switcher.
- ⑤ **INPUT:** Six bicolor back-lit buttons for input source selection.
- ⑥ **OUTPUT:** Four bicolor back-lit buttons for output channel selection.
- ⑦ **A & V:** Two bicolor back-lit buttons for audio or video switching.
- ⑧ **Function Buttons:**
 - **LOCK:** Lock or unlock the front panel buttons.
 - **PRESET:** Preset setting.
 - **MENU/↓ :** Menu or confirm button.
 - **BACK:** Go back to the previous page.
 - **UP:** Page up.
 - **DOWN:** Page down.

Note: Please refer to section [5. Front Panel Control](#) for more details about switch operation.

6x4+2 18G HDMI 2.0 Matrix Switcher with HDBT

3.2 Rear Panel

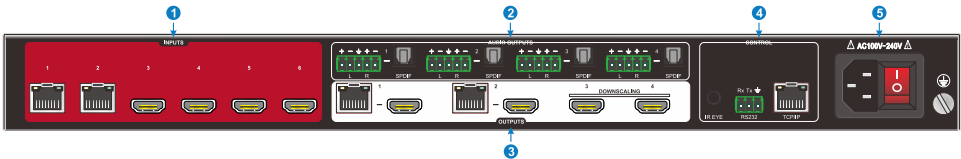

- ① **INPUTS:** Two HDBaseT RJ45 inputs to connect with the HDBaseT transmitters, four type-A female HDMI input ports to connect with HDMI sources.
- ② **AUDIO OUTPUTS:** Four 3-pin terminal blocks and four Toslink connectors to connect with speakers or amplifiers for HDMI/HDBaseT input audio de-embedding or HDMI/HDBaseT output audio de-embedding. The audio matrix routing can be set by front panel buttons, IR Remote, GUI, RS232 or TCP/IP commands.
- ③ **OUTPUTS:** Two HDBaseT RJ45 outputs to connect with the HDBaseT receivers, and four local HDMI ports to connect with the local displays.
- ④ **CONTROL:**
 - **IR EYE:** Connect with included IR receiver to use the included IR remote for controlling the Matrix Switcher.
 - **RS232:** 3-pin terminal block to connect the control device (e.g. PC or control system) to control the matrix switcher, HDBaseT TX/RX or third-party devices by RS232 commands.
 - **TCP/IP:** RJ45 port to connect the control device (e.g. PC) to control the matrix switcher by GUI or TCP/IP commands.
- ⑤ **POWER:** AC connector for power cable.

6x4+2 18G HDMI 2.0 Matrix Switcher with HDBT

4. System Connection

4.1 Usage Precaution

- Make sure all components and accessories are included before installation.
- System should be installed in a clean environment with proper temperature and humidity.
- All of the power switches, plugs, sockets, and power cords should be insulated and safe.
- All devices should be connected before powering on the system.

4.2 System Diagram

The following diagram illustrates typical input and output connections that can be utilized with this matrix switcher and TiGHT AV compatible HDBT transmitters and receivers:

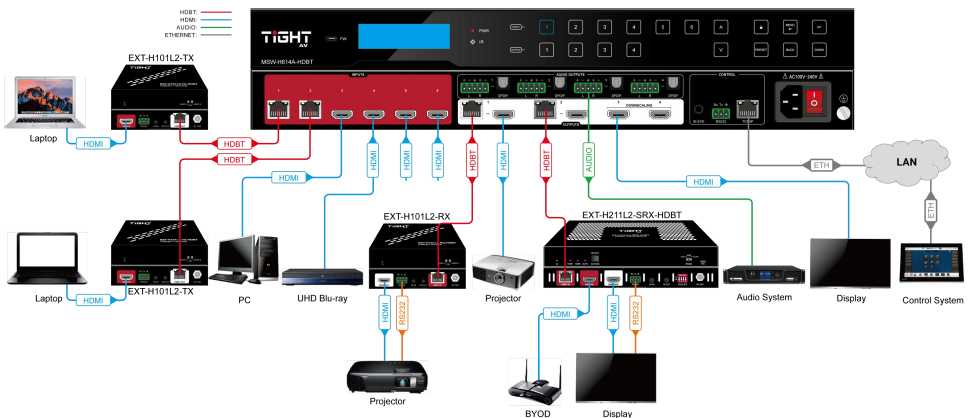

5. Front Panel Control

The matrix switcher can be controlled by using the buttons on the front panel. In normal working state, all buttons illuminate white with backlight, and it will illuminate blue when it is clicked. If there is no operation within 30s, the front panel enters the dormant state, and all the button backlights are off. In the dormant state, touching any of the buttons or sending commands can activate the front panel.

5.1 Signal switching

- **Switch an input to an output**

Operation: INPUT# + OUTPUT# + A (Audio) or V (Video) button

Example: Switch Input 1 to Output 2:

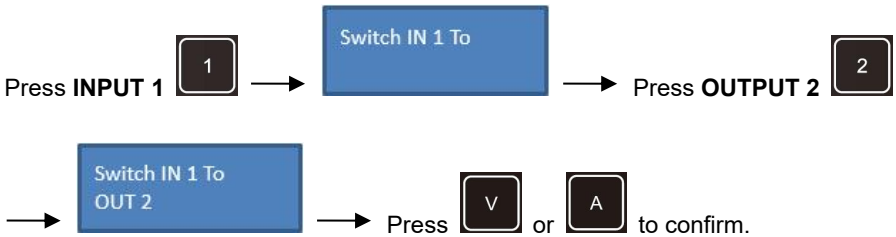

- **Switch an input to several outputs**

Operation: INPUT# + OUTPUT# + OUTPUT# + ... + V or A

Example: Switch Input 1 to Output 2, 3, and 4..

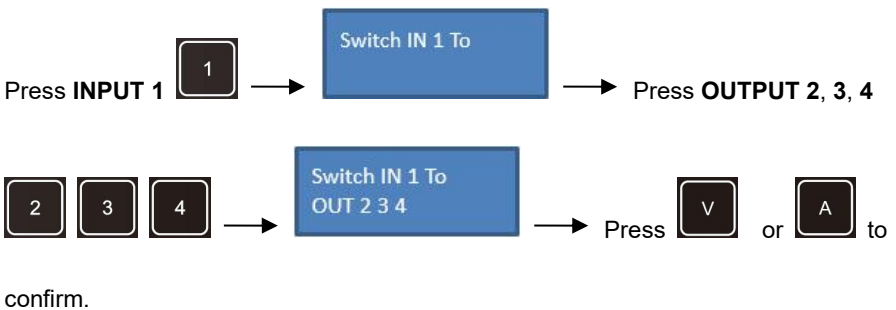

5.2 Current routing status

Press → → Press enter status information tab. → Press or navigation buttons to check the previous or next item respectively.

LCD Screen	Description
	Report the video signal switching status.
	Report the audio signal switching status.

5.3 Front Panel Lock/Unlock

Press and hold at least three seconds. → → Press and hold to unlock. →

5.4 Audio Settings

The matrix switcher provides 4 analog L+R audio output ports and 4 digital SPDIF output ports for audio de-embedding. The audio source selection of these 4 audio output ports, and the L+R audio volume can be controlled by the front panel buttons.

- Audio Volume Control**

Example: Set the audio volume of L+R OUT 2 port.

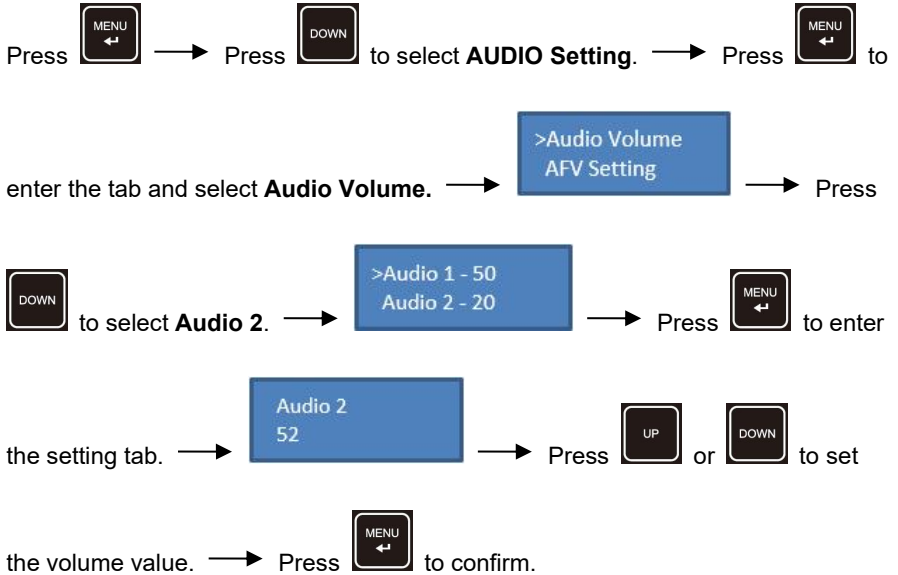

- Audio Follow Video Control**

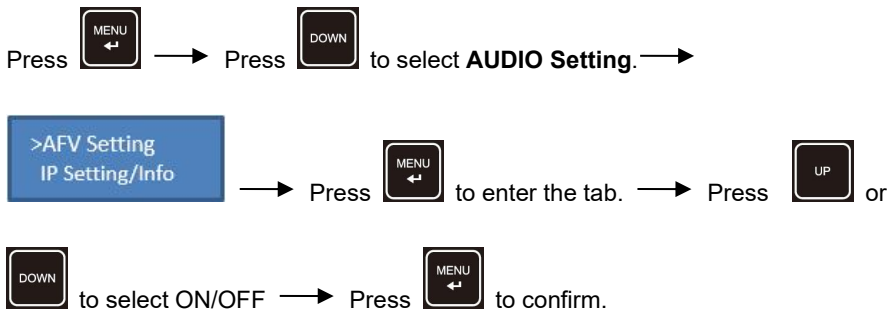



5.5 Preset Save/Recall Function

Press **PRESET** button can save the current video and audio routing and audio settings or load a saved layout preset. The matrix supports up to 6 presets.

- **Save the current video and audio routing and audio settings to a preset**

Example: Save the current layout to preset 2.

Press and hold  at least 3 seconds and then press **INPUT 2**  to select

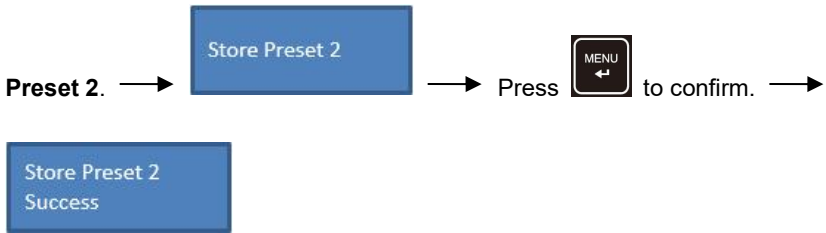

- **Recall a saved preset**

Example: Recall the saved preset 2.

Press  and then press **INPUT 2**  to select **Preset 2.** →

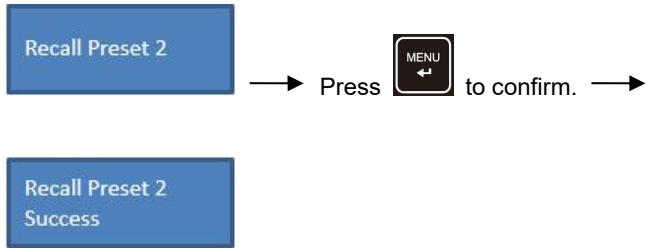

5.6 IP Address Inquiry

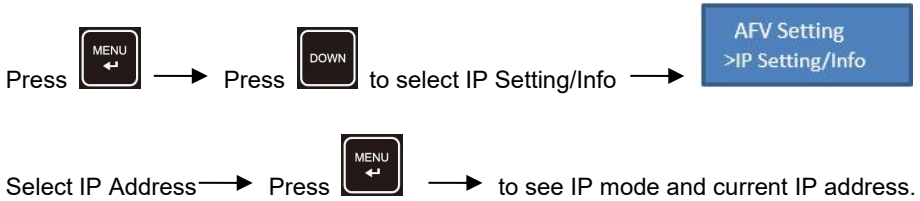

5.7 Switch IP Mode using Front Panel

To switch between Static IP mode and DHCP IP mode using front panel. Either use the menu to navigate as above to IP Setting/Info.

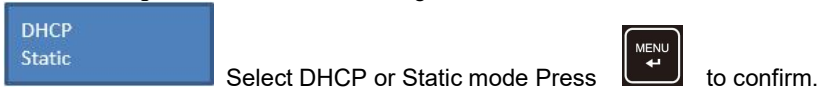

Users can also press and hold and simultaneously for at least three seconds. This will enter the IP Setting/Info tab directly in menu.

Select DHCP or Static mode and press to confirm
 If switching from Static to DHCP mode, please allow some time for the network to assign a new IP-address.

6x4+2 18G HDMI 2.0 Matrix Switcher with HDBT**6. GUI Control**

The switcher features a Web UI for configuration and control. The default IP settings are:

IP Address: 192.168.0.178

Subnet Mask: 255.255.255.0

Type 192.168.0.178 in the web browser, it will enter the below log-in webpage:

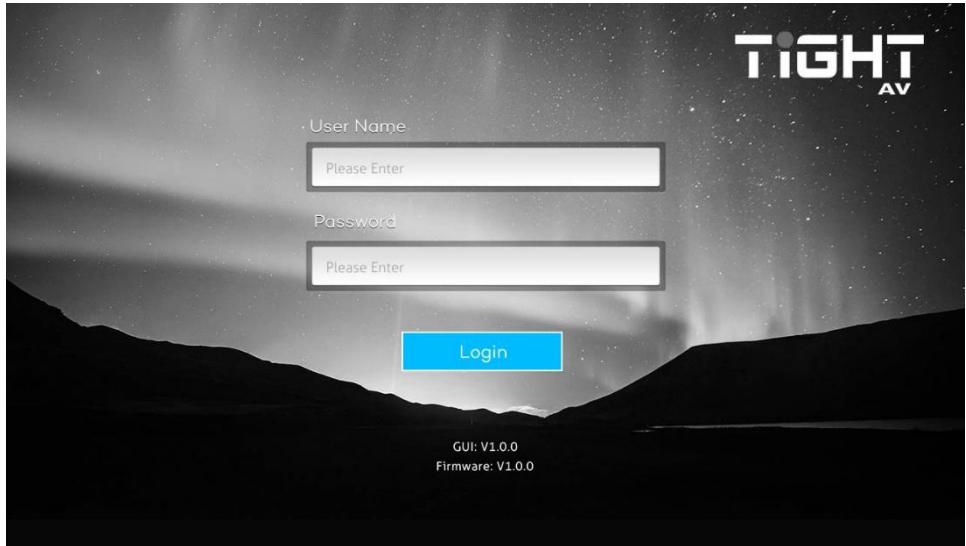

Username: admin

Password: admin

Type the user name and password, and then click Login to enter Web UI.

6.1 AV Routing

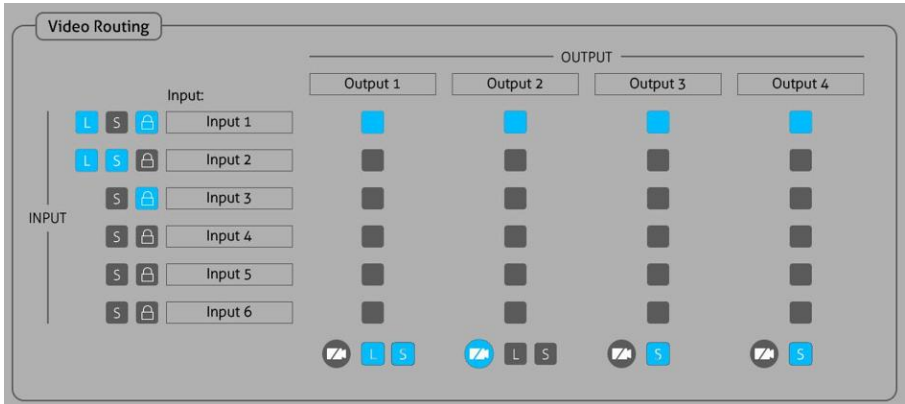

- **Video Routing**

Use the 6x4 button grid on the page to set which inputs are directed to which outputs. For example, clicking the button on the Input 1 row and Output 1 column, directs input 1 to output 1.



: HDBT IN/OUT Link status.



: INPUT/OUTPUT Signal status (active video).



: INPUT HDCP status.



: Mute Video. Sends out black video to keep connection to display.

6x4+2 18G HDMI 2.0 Matrix Switcher with HDBT

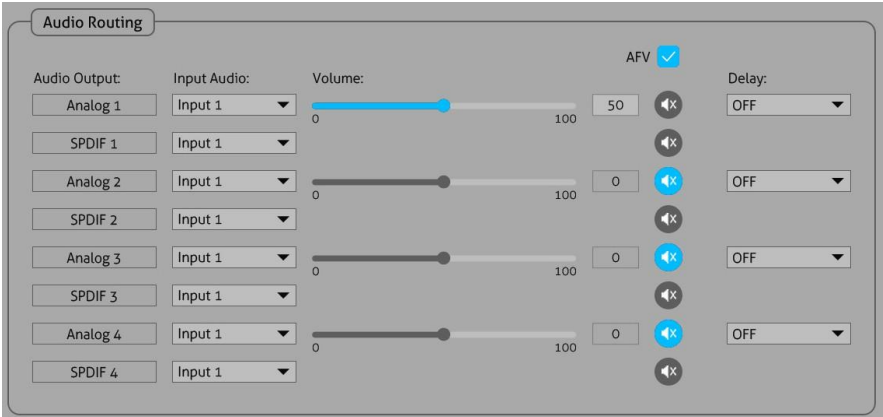

• **Audio Routing**

Use the drop-list to select to de-embed audio from input or output source.



Audio Follow Video: The audio source is always de-embedded from the video input to the corresponding audio output. Example: Video input 1 is routed to video output 2 then the audio de-embedded from video input 1 is routed to audio output 2.

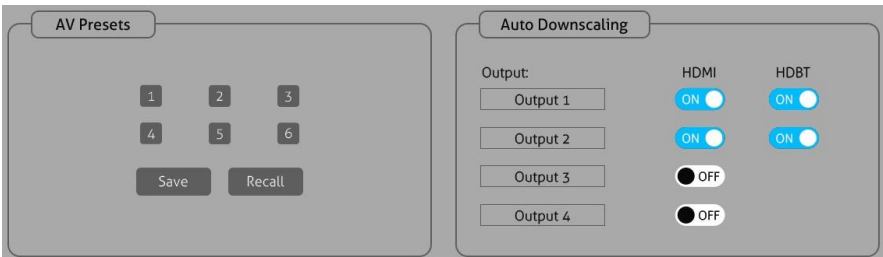

• **AV Presets & Auto-Downscaling**

Use the 6 numbered buttons under AV Presets area to save and load layout presets. AV presets saves and recalls both Audio settings and Video settings.

To save a given layout, first click one of the numbered buttons, then click the **Save** button.

To load a previously saved layout, first click one of the numbered buttons, then click the **Recall** button.

6x4+2 18G HDMI 2.0 Matrix Switcher with HDBT

6.2 I/O Configuration

Input	EDID	User-defined	Browser	Upload
Input 1	3840x2160@60Hz Deep Color Stereo Audio (Default)	User-defined 1	Browse	Upload file
Input 2	3840x2160@60Hz Deep Color Stereo Audio (Default)	User-defined 2	Browse	Upload file
Input 3	3840x2160@60Hz Deep Color Stereo Audio (Default)	User-defined 3	Browse	Upload file
Input 4	3840x2160@60Hz Deep Color Stereo Audio (Default)	User-defined 4	Browse	Upload file
Input 5	3840x2160@60Hz Deep Color Stereo Audio (Default)	User-defined 5	Browse	Upload file
Input 6	3840x2160@60Hz Deep Color Stereo Audio (Default)	User-defined 6	Browse	Upload file

Press Save to Confirm

Save

- **EDID Settings**

Drop-down the EDID list to select EDID for input ports.

How to upload user-defined EDID:

- 1) Prepare the EDID file (.bin) on the control PC.
- 2) Select **Browse** and then select the EDID file (.bin) accordingly.
- 3) Click **Upload file**.
- 4) Choose the User-defined EDID in the drop-down list, and then click **Save** to save setting.
- 5) Set a user-friendly name under Device Setting section.

6x4+2 18G HDMI 2.0 Matrix Switcher with HDBT

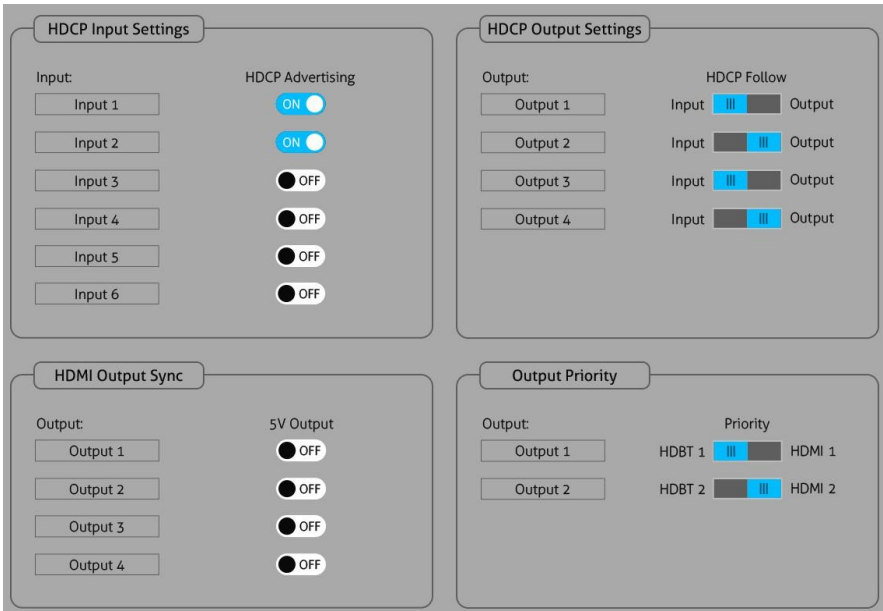

- HDCP Input Settings:** HDCP Advertising ON/OFF. When ON state the input presents itself as HDCP compatible. When OFF the input presents itself as non-HDCP compatible (to use in applications with for e.g. Apple devices to prevent HDCP encryption for content that doesn't require encryption).
- HDCP Output Settings:**
 - Follow Input: Follow the HDCP version of input source.
 - Follow Output: Follow the HDCP version of the display.

Note: Only applies when input content is HDCP encrypted. If the input content is not HDCP encrypted the output is also not HDCP encrypted
- HDMI Output Sync:**

When there is no input signal routed to the current output, the output has two state options:

 - Output without 5V (default) – OFF
 - Only output 5V - ON
 - Output Priority:** The selection of priority (HDMI or HDBT) of EDID and information displayed to the routed input. If HDBT is selected as priority then EDID and HDCP information from HDBT output is active as long as it is connected.

6.3 Device Settings

Device Settings

<p>Model Name: MSW-H614A-HDBT</p> <p>MAC Address: 00-00-00-00-00</p> <p>Serial Number: 000000000000</p> <p>Firmware Version: V1.00</p>	<p>Firmware Update: <input type="text" value="E:\"/> Browse Update</p> <p>Factory Reset: Factory Reset</p> <p>Reboot Unit: Browse</p>
--	--

- **Device Settings**

- 1) Display the model's name, mac address, serial number, firmware version.
- 2) Firmware Update: Updates the MCU firmware.
- 3) Factory Reset: Reset the unit to factory.
- 4) Reboot Unit: Reboots the unit.

Network

DHCP
Static

IP Address:

Subnet:

Gateway:

Set Changes: Confirm

Access

WEB UI Credentials

Password: Save

Lock Front Panel: OFF

- **Network**

- 1) Static IP or DHCP (Dynamic Host Configuration Protocol).
- 2) Modify the static IP Address, Subnet Mask, and Gateway.

- **Access**

- 1) Change Password for Web UI and web server access.
- 2) Lock front panel to prevent pressing of the front panel buttons by mistake.

6x4+2 18G HDMI 2.0 Matrix Switcher with HDBT

- **Input Name, Output Name, Audio Output Name, User-defined EDID Name, User-defined RS232 Name.**

User-defined interface naming or identification naming.

- **PoC Setting**

Enable or disable PoC (Power over Category Cable). Power supplied over HDBT to transmitters and receivers from MSW-H614A-HDBT. This can be a very useful feature to re-boot transmitters and receivers if needed.

The screenshot displays a configuration interface with six panels, each containing input fields and a 'Save' button:

- Input Name:** Six input fields labeled Input 1 through Input 6.
- Output Name:** Four input fields labeled Output 1 through Output 4.
- Audio Output Name:** Eight input fields in two columns: Analog 1-4 and SPDIF 1-4.
- User-defined EDID Name:** Four input fields labeled User-defined 1 through User-defined 4.
- User-defined RS232 Name:** Three input fields, with the first two labeled 'User-defined 1' and the third labeled 'User-defined 1'.
- PoC Setting:** A table with two columns: 'Port' and 'PoC'. The 'PoC' column contains radio buttons, all of which are currently set to 'OFF'.

Port	PoC
HDBT In 1	OFF
HDBT In 2	OFF
HDBT Out 1	OFF
HDBT Out 2	OFF

6x4+2 18G HDMI 2.0 Matrix Switcher with HDBT

6.4 CEC

If the input source devices and local HDMI output devices support CEC, they can be controlled via the following CEC interface.

- **Input CEC**

Select one or several HDMI input source devices to be controlled, and then press function buttons.

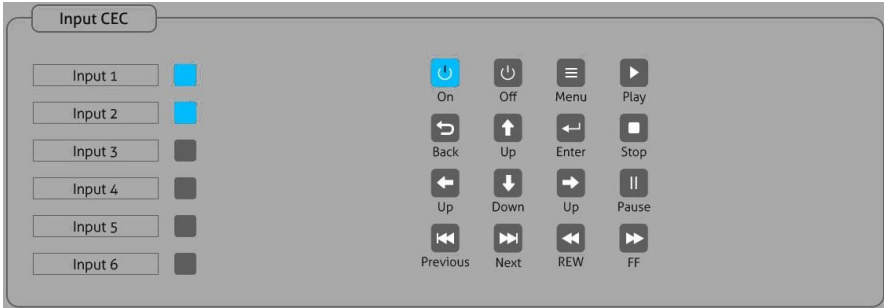

- **Output CEC**

Select one or two HDMI output devices to be controlled, and then press function buttons.

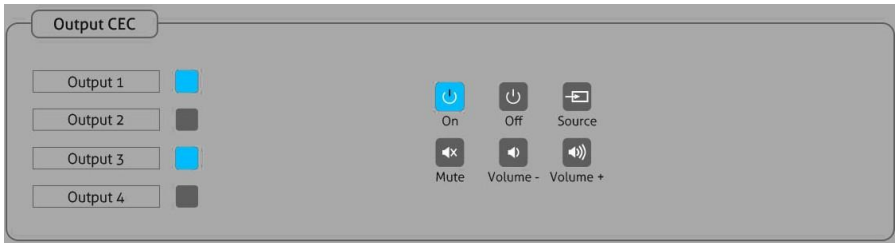

6x4+2 18G HDMI 2.0 Matrix Switcher with HDBT

6.5 Control

- **RS232**

- 1) RS232 Routing:

- Local: Send RS232 commands to control the local or remote third-party device.

Select the controlled

port: Local HDBT In 1 HDBT In 2 HDBT Out 1 HDBT Out 2

- Tx <-> Rx: The transmitter at the front end transmits RS232 commands to control a third-party device of the receiver at the back end, or the third-party device of the transmitter is controlled by the receiver. (HDBT IN 1 corresponds HDBT OUT 1, HDBT IN 2 corresponds HDBT OUT 2, and this correspondence is fixed and cannot be changed)
- Tx -> Matrix: The transmitter at the front stage transmits RS232 commands to control the Matrix (If both HDBT IN 1 and HDBT IN 2 send RS232 commands, the matrix will receive the commands from the two ports in order.) A third-party device connected to the local RS23 port of the matrix can be controlled by using *sendascii* or *sendhex* command described in section 8.3.6.
- Rx -> Matrix: The receiver at the back end transmits RS232 commands to control the Matrix (If both HDBT IN 1 and HDBT IN 2 send RS232 commands, the matrix will receive the commands from the two ports in order.) A third-party device connected to the local RS23 port of the matrix can be controlled by using *sendascii* or *sendhex* command described in section 8.3.6

- 2) ASCII or HEX command format can be selected for the User-Defined Commands 1-3.

6x4+2 18G HDMI 2.0 Matrix Switcher with HDBT

- 3) Baud Rate: Supports 2400, 4800, 9600, 19200, 38400, 57600 or 115200.
- 4) Command Ending: NULL, CR, LF or CR+LF can be chosen.
- 5) User-defined Command: Type the command in this box to control the third-party device which is connected to the RS232 port of the switcher. Set a user-friendly name under Device Setting section.
- 6) Select which port to send the user-defined command and press Send:

Local
HDBT In 1
HDBT In 2
HDBT Out 1
HDBT Out 2

- **Unsolicited Status**

The Unsolicited Status feature allows for automatically sending the full status report (see command getstatus response in the **8.3 Command Protocol** section) to a user defined IP-Address, UDP Port and interval.

- 1) Function switch: ON/OFF
- 2) Send Status Port: User-defined UDP port
- 3) Send Status IP Address: Send to the specified IP address
- 4) Status Interval (1-3600 sec): Sending interval

Unsolicited Status

Unsolicited Status: OFF

Send Status Port:

Send Status IP Address:

Status Intervall (1 - 3600 sec):

7. IR Control

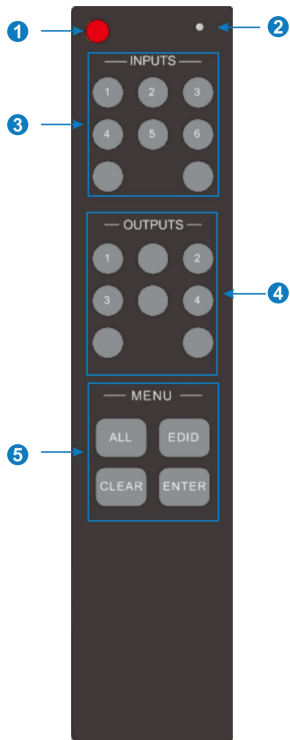

current operation, if

①. Enter/exit standby mode.

②. Blinking red when a button is pressed.

③. Video source selection buttons.

④. Output channel selection buttons.

⑤. Menu buttons:

- ALL: Select all inputs or all outputs.

- EDID: Enable one or several input sources to

manually capture and

learn the EDID data of

output device.

- CLEAR: Cancel the

ENTER has not been pressed.

- ENTER: Confirm the desired operation.

8. Device Control

8.1 RS232

Connect the RS232 port to control device (e.g. PC) with RS232 cable. The switcher can be controlled by sending RS232 commands.

The list of command is used to control the switcher. The RS232 control software (e.g. Docklight) needs to be installed on the control PC to send RS232 commands.

After installing the RS232 control software, please set the parameters of COM number, bound rate, data bit, stop bit and the parity bit correctly, and then you are able to send command in command sending area.

Communication protocol: RS232 Communication Protocol

Baud rate: 9600 Data bit: 8 Stop bit: 1 Parity bit: none

8.2 TCP/IP Control

The system can be controlled over a network connection. A TCP/IP communication software (e.g. Docklight) needs to be installed on the control PC. After installing the control software, create a connection according to the below parameters:

Default IP-Address: 192.168.0.178

Default Subnet Mask: 255.255.255.0

Default Gateway: 192.168.0.1

TCP Port Number: 4001

Note:

Command ending symbol <CR>

Feedback ending with symbols <CR><LF>

Delimiter symbol “!”

Please type the command carefully due to case sensitivity.

8.3 Command Protocol

8.3.1 Device Settings

Command	Description	Command & Feedback Example
poweron	Exit standby mode	poweron ok
poweroff	Exit standby mode	poweroff ok
getstatus	Query system status and port status.	6x4+2 presentation matrix switcher w/ audio matrix! msw-h614a-hdbt! firmware:1.0.0! poweron! rs232mode,1! hdbtpoweron:1! hdbtpoweroff:2! hdbtpoweroff:3! hdbtpoweroff:4! fplock:off! setbaudrate:3! ip:192.168.003.003! set,1:eh! set,2:eh! set,1:4! set,2:4! set,3:4! set,4:4! hdmiblackoff,1! hdmiblackoff,2! hdmiblackoff,3! hdmiblackoff,4! hdmisyncon,1! hdmisyncon,2! hdmisyncon,3! hdmisyncon,4! downscaleoff,1!

6x4+2 4K@60 4:4:4 Matrix Switcher w/ Audio Matrix

		<p> downscaleoff,2! downscaleoff,3! downscaleoff,4! downscaleon,5! downscaleon,6! remotecontroliroff:1 ok! remotecontroliroff:2 ok! remotecontroliroff:3 ok! remotecontroliroff:4 ok! audiofollowon! seta,1:4! seta,2:4! seta,3:4! seta,4:4! analogdelay,1:225! analogdelay,2:225! analogdelay,3:225! analogdelay,4:225! spdifmute,1! spdifmute,2! spdifmute,3! spdifmute,4! lovol,1:61! lovol,2:61! lovol,3:61! lovol,4:61! unmute,1! unmute,2! unmute,3! unmute,4! in 1 2 3 4 5 6 link n n y y n n out 1 2 3 4 link y n n y edid,1:1 copy! edid,2:7 internal! edid,3:7 internal! edid,4:7 internal! edid,5:7 internal! edid,6:7 internal! in 1 on! </p>
--	--	---

6x4+2 4K@60 4:4:4 Matrix Switcher w/ Audio Matrix

		<p>in 2 on! in 3 on! in 4 on! in 5 on! in 6 on! out 5 follow display! out 2 follow display! out 3 follow input! out 4 follow input! in 1 hdcppoff! in 2 hdcppoff! in 3 hdcp1.4! in 4 hdcppoff! in 5 hdcppoff! in 6 hdcppoff!</p>
getfirmware	Query the firmware version	firmware:1.0.0!
reset	Reset to factory default	reset ok
fplockon	Turn on the front panel lock	fplock:on ok
fplockoff	Turn off the front panel lock	fplock:off ok
setbaudrate:7	Set the serial port baud rate to 115200.	setbaudrate:7 ok
setbaudrate:6	Set the serial port baud rate to 57600.	setbaudrate:6 ok
setbaudrate:5	Set the serial port baud rate to 38400.	setbaudrate:5 ok
setbaudrate:4	Set the serial port baud rate to 19200.	setbaudrate:4 ok
setbaudrate:3	Set the serial port baud rate to 9600.	setbaudrate:3 ok
setip:xxx.xxx.xxx.xxx	Set IP of the device	setip:xxx.xxx.xxx.xxx ok
setipstatic	Set IP mode to Static	setipstatic ok
setipdhcp	Set IP mode to DHCP	setipdhcp ok setip:192.168.0.102 ok
getip	Query IP of the device	setipstatic! ip:192.168.0.178! setipdhcp! ip:192.168.0.100!

8.3.2 AV Routing

Command	Description	Command & Feedback Example
set,y:x	Switch video input [x] to output [y] x = 1 - 6 1 - input 1 2 - input 2 3 - input 3 4 - input 4 5 - input 5 6 - input 6 y = 1 - 4 0 - all outputs 1 - output 1 2 - output 2 3 - output 3 4 - output 4	set,1:4 ok set,2:4 ok set,3:4 ok set,4:4 ok
getset	Query the video routing of all outputs	set,1:1! set,2:1! set,3:2! set 4:2!
getset,y	Query the input source of output port [y] y = 0 - 4 1 - output 1 2 - output 2 3 - output 3 4 - output 4	set,1:2!

6x4+2 4K@60 4:4:4 Matrix Switcher w/ Audio Matrix

seta,y:x	<p>Set audio output y de-embedded from x</p> <p>x = 1 - 10</p> <p>01~06 - De-embedded from HDMI input 1-6</p> <p>07~10 - De-embedded from HDMI output 1-4</p> <p>y = 1 - 4</p> <p>0 - all outputs</p> <p>1 - output 1</p> <p>2 - output 2</p> <p>3 - output 3</p> <p>4 - output 4</p>	<p>seta,1:4 ok</p> <p>seta,2:4 ok</p> <p>seta,3:4 ok</p> <p>seta,4:4 ok</p>
getseta	<p>Query audio switching status.</p>	<p>audiofollowon!</p> <p>seta,1:2!</p> <p>seta,2:1!</p> <p>seta,3:2!</p> <p>seta,4:1!</p>
getseta,y	<p>Query the input source of audio output port [y]</p> <p>y = 0 - 4</p> <p>1 - output 1</p> <p>2 - output 2</p> <p>3 - output 3</p> <p>4 - output 4</p>	<p>seta,1:2!</p>

8.3.3 Audio Settings

Command	Description	Command & Feedback Example
lovolinc:y	lovolinc: volume up for specified port	lovolinc,1 ok
lovoldec:y	lovoldec: volume down for specified port	lovol,1:61 ok

6x4+2 4K@60 4:4:4 Matrix Switcher w/ Audio Matrix

<p>mute:y</p> <p>unmute:y</p> <p>lovol,y:z</p>	<p>mute: mutes the specified port</p> <p>unmute: unmutes the specified port</p> <p>lovol: volume level for specified port</p> <p>y = 0 - 4</p> <p>0 - all analog audio outputs</p> <p>1 - analog audio output 1</p> <p>2 - analog audio output 2</p> <p>3 - analog audio output 3</p> <p>4 - analog audio output 4</p> <p>z= 0 - 100 (volume level)</p>	<p>lovolinc,2 ok</p> <p>lovol,2:61 ok</p> <p>lovolinc,3 ok</p> <p>lovol,3:61 ok</p> <p>lovolinc,4 ok</p> <p>lovol,4:61 ok</p>
<p>getaudiolevels</p>	<p>Query analog audio volume and mute status.</p>	<p>lovol,1:75!</p> <p>lovol,2:75!</p> <p>lovol,3:75!</p> <p>lovol,4:25!</p> <p>unmute,1!</p> <p>unmute,2!</p> <p>mute,3!</p> <p>mute,4!</p>
<p>analogdelay,y:z</p>	<p>Set the delay time of analog audio output[y]</p> <p>y is the output port (0 for all)</p> <p>z is delay time in ms (0 - 250 ms)</p> <p>y = 0 - 2</p> <p>0 - all analog audio outputs</p> <p>1 - analog audio output 1</p> <p>2 - analog audio output 2</p> <p>z = 0 - 250 : Set the delay time</p>	<p>analogdelay,1:100 ok</p> <p>analogdelay,2:100 ok</p> <p>analogdelay,3:100 ok</p> <p>analogdelay,4:100 ok</p>

6x4+2 4K@60 4:4:4 Matrix Switcher w/ Audio Matrix

getanalogdelay,y	<p>Query delay status of analog audio output [y] in ms.</p> <p>y = 0 - 4</p> <p>0 - all analog audio outputs</p> <p>1 - analog audio output 1</p> <p>2 - analog audio output 2</p> <p>3 - analog audio output 3</p> <p>4 - analog audio output 4</p>	analogdelay,3:100!
spdifmute,y spdifunmute,y	<p>Turns on or off spdif on specified output port y</p> <p>x = 0 - 4</p> <p>0 - all SPDIF outputs</p> <p>1 - SPDIF output 1</p> <p>2 - SPDIF output 2</p> <p>3 - SPDIF output 3</p> <p>4 - SPDIF output 4</p>	<p>spdifmute,1 ok</p> <p>spdifunmute,1 ok</p>
getspdif	<p>Query digital audio mute status.</p>	<p>spdifmute,1!</p> <p>spdifmute,2!</p> <p>spdifunmute,3!</p> <p>spdifunmute,4!</p>
audiofollowon	Activate Audio Follow Video	audiofollowon ok
audiofollowoff	Deactivate Audio Follow Video	audiofollowoff ok

8.3.4 HDCP Management

Command	Description	Command & Feedback Example
hdcpadvertisingon,y	<p>Enable HDCP advertising (HDCP compatibility mode) on input [y]</p> <p>y = 0 - 6</p>	hdcpadvertisingon,1 ok

6x4+2 4K@60 4:4:4 Matrix Switcher w/ Audio Matrix

	<p>0 - all inputs</p> <p>1 - input 1</p> <p>2 - input 2</p> <p>3 - input 3</p> <p>4 - input 4</p> <p>5 - input 5</p> <p>6 - input 6</p>	
hdcpadvertisingoff,y	<p>Disable HDCP advertising (HDCP compatibility mode) on input [y]</p> <p>y = 0 - 6</p> <p>0 - all inputs</p> <p>1 - input 1</p> <p>2 - input 2</p> <p>3 - input 3</p> <p>4 - input 4</p> <p>5 - input 5</p> <p>6 - input 6</p>	hdcpadvertisingoff,1 ok
gethdcpadvertising	<p>Query HDCP advertising status (HDCP compatibility mode).</p>	<p>in 1 on!</p> <p>in 2 off!</p> <p>in 3 on!</p> <p>in 4 off!</p> <p>in 5 off!</p> <p>in 6 on!</p>
hdcp,y:on	<p>Enable HDCP always on for output [y]</p> <p>y = 0 - 4</p> <p>0 - all outputs</p> <p>1 - output 1</p> <p>2 - output 2</p> <p>3 - output 3</p> <p>4 - output 4</p>	hdcp,4:on ok

6x4+2 4K@60 4:4:4 Matrix Switcher w/ Audio Matrix

hdcpfollowdisplay,y	<p>y is the output 0 (all),1 – 4</p> <p>y = 0 - 4</p> <p>0 - all outputs</p> <p>1 - output 1</p> <p>2 - output 2</p> <p>3 - output 3</p> <p>4 - output 4</p>	hdcpfollowdisplay,1 ok
hdcpfollowinput,y	<p>Output [y] HDCP mode follows the input source</p> <p>y = 0 - 4</p> <p>0 - all outputs</p> <p>1 - output 1</p> <p>2 - output 2</p> <p>3 - output 3</p> <p>4 - output 4</p>	hdcpfollowinput,2 ok
gethdcpoutputs	<p>Query the current HDCP mode for all output ports.</p>	<p>out 1 follow display!</p> <p>out 2 follow input!</p> <p>out 3 follow display!</p> <p>out 4 on!</p>

8.3.5 EDID Management

Command	Description	Command & Feedback Example
resetedid,x	<p>Reset to the default EDID for input [x]</p> <p>x = 0 - 6</p> <p>0 - all inputs</p> <p>1 - input 1</p> <p>2 - input 2</p> <p>3 - input 3</p> <p>4 - input 4</p> <p>5 - input 5</p> <p>6 - input 6</p>	resetedid,4 ok

6x4+2 4K@60 4:4:4 Matrix Switcher w/ Audio Matrix

<p>setuseredid:xx</p>	<p>Upload user-defined EDID for input [xx] xx = 00 - 06 00 - all inputs 01 - input 1 02 - input 2 03 - input 3 04 - input 4 05 - input 5 06 - input 6</p> <p>xx = U1 - U4 U1 - user-defined EDID 1 U2 - user-defined EDID 1 U3 - user-defined EDID 1 U4 - user-defined EDID 1</p>	<p>setuseredid:U1 ok</p>
<p>setedid,x:zz</p>	<p>Set EDID zz for input [x]</p> <p>x = 0 – 6 0 - all inputs 1 - input 1 2 - input 2 3 - input 3 4 - input 4 5 - input 5 6 - input 6</p> <p>zz = 01 - 12</p> <p>01 - 1920x1080@60 8bit Stereo 02 - 1920x1080@60 8bit High Definition Audio 03 - 3840x2160@30Hz 8bit Stereo Audio 04 - 3840x2160@30Hz Deep Color High Definition Audio 05 - 3840x2160@60Hz 4:2:0 Deep</p>	<p>setedid,6:01 ok</p>

6x4+2 4K@60 4:4:4 Matrix Switcher w/ Audio Matrix

	<p>Color Stereo Audio</p> <p>06 - 3840x2160@60Hz Deep Color Stereo Audio (default)</p> <p>07 - 3840x2160@60Hz Deep Color High Definition Audio</p> <p>08 - 3840x2160@60Hz Deep Color HDR LPCM 6CH</p> <p>09 - User-defined EDID 1</p> <p>10 - User-defined EDID 2</p> <p>11 - User-defined EDID 3</p> <p>12 - User-defined EDID 4</p>	
getedidout,y	<p>Read the output [y] EDID and print it.</p> <p>y = 1 - 4</p> <p>1 - output 1 (Only HDBT port)</p> <p>2 - output 2 (Only HDBT port)</p> <p>3 - output 3</p> <p>4 - output 4</p>	getedidout,2:
edidcopy,y,x	<p>Copies edid from output [y] and set to input [x]</p> <p>y = 1 - 4</p> <p>1 - output 1</p> <p>2 - output 2</p> <p>3 - output 3</p> <p>4 - output 4</p> <p>x = 0 - 6</p> <p>0 - all inputs</p> <p>1 - input 1</p> <p>2 - input 2</p> <p>3 - input 3</p>	edidcopy,1,1 ok

6x4+2 4K@60 4:4:4 Matrix Switcher w/ Audio Matrix

	<p>4 - input 4</p> <p>5 - input 5</p> <p>6 - input 6</p>	
getedidin,x	<p>Query EDID of input [x]</p> <p>x = 0 - 6</p> <p>0 - all inputs</p> <p>1 - input 1</p> <p>2 - input 2</p> <p>3 - input 3</p> <p>4 - input 4</p> <p>5 - input 5</p> <p>6 - input 6</p>	<p>edid,1:1 internal!</p> <p>edid,2:1 internal!</p> <p>edid,3:1 internal!</p> <p>edid,4:1 internal!</p> <p>edid,5:1 internal!</p> <p>edid,6:1 internal!</p>

8.3.6 Function Settings

Command	Description	Command & Feedback Example
downscaleon,y	<p>Enable the auto-downscaler of output [y]</p> <p>y = 0 – 6</p> <p>0 - all outputs</p> <p>1 - HDMI output 1</p> <p>2 - HDMI output 2</p> <p>3 - HDMI output 3</p> <p>4 - HDMI output 4</p> <p>5 - HDBT output 1</p> <p>6 - HDBT output 2</p>	downscaleon,4 ok
downscaleoff,y	<p>Disable the auto-downscaler of output [y]</p> <p>y = 0 – 6</p> <p>0 - all outputs</p> <p>1 - HDMI output 1</p>	downscaleoff,4 ok

6x4+2 4K@60 4:4:4 Matrix Switcher w/ Audio Matrix

	<p>2 - HDMI output 2</p> <p>3 - HDMI output 3</p> <p>4 - HDMI output 4</p> <p>5 - HDBT output 1</p> <p>6 - HDBT output 2</p>	
getdownscale	<p>Query the downscaling status of the all output ports</p>	<p>downscaleon,1!</p> <p>downscaleon,2!</p> <p>downscaleon,3!</p> <p>downscaleon,4!</p> <p>downscaleon,5!</p> <p>downscaleon,6!</p>
gethdmis5voltinputs	<p>Query HDMI inputs 5V status.</p>	<p>in 1 2 3 4 5 6</p> <p>link n n y n n n</p>
gethpdoutputs	<p>Query output port HPD (Hot Plug Detect) connection status.</p>	<p>out 1 2 3 4</p> <p>link n n y n</p>
savepreset:z	<p>saves current settings to preset number [z]</p> <p>z = 1 - 9</p>	<p>savepreset:1 ok</p>
getpreset:z	<p>Get information about preset number [z]</p> <p>z = 0 - 9</p>	<p>getpreset:1 ok</p> <p>set,1:1!</p> <p>set,2:1!</p> <p>set,3:1!</p> <p>set,4:1!</p> <p>seta,1:2!</p> <p>seta,2:1!</p> <p>seta,3:8!</p> <p>seta,4:5!</p> <p>analogdelay,1:50!</p> <p>analogdelay,2:100!</p> <p>analogdelay,3:150!</p> <p>analogdelay,4:200!</p>

6x4+2 4K@60 4:4:4 Matrix Switcher w/ Audio Matrix

		spdifmute,1! spdifmute,2! spdifmute,3! spdifmute,4! lovol,1:53! lovol,2:38! lovol,3:15! lovol,4:80! unmute,1! unmute,2! unmute,3! unmute,4! hdmiblackon,1! hdmiblackoff,2! hdmiblackon,3! hdmiblackon,4!
<p>loadpreset:z</p>	<p>Recall the preset [z]and prints out the video and audio routing in the preset</p> <p>z = 1 - 9</p>	loadpreset:1 ok! set,1:1! set,2:1! set,3:1! set,4:1! seta,1:1! seta,2:2! seta,3:3! seta,4:10! analogdelay,1:10! analogdelay,2:238! analogdelay,3:145! analogdelay,4:163! spdifmute,1! spdifmute,2!

6x4+2 4K@60 4:4:4 Matrix Switcher w/ Audio Matrix

		spdifmute,3! spdifmute,4! lovol,1:100! lovol,2:38! lovol,3:15! lovol,4:80! unmute,1! unmute,2! unmute,3! unmute,4! hdmiblackon,1! hdmiblackoff,2! hdmiblackon,3! hdmiblackon,4!
hdmisyncon,y	Turn on the HDMI Sync mode (5V) of output [y]. y = 0 – 4 0 - all outputs 1 - output 1 2 - output 2 3 - output 3 4 - output 4	hdmisyncon,1 ok
hdmisyncoff,y	Turn off the HDMI Sync mode (5V) of output [y] y = 0 – 4 0 - all outputs 1 - output 1 2 - output 2 3 - output 3 4 - output 4	hdmisyncoff,1 ok
hdmiblackon,y	Turn on the Video black of output[y]	hdmiblackon,1 ok

6x4+2 4K@60 4:4:4 Matrix Switcher w/ Audio Matrix

	<p>y = 0 – 4</p> <p>0 - all outputs</p> <p>1 - output 1</p> <p>2 - output 2</p> <p>3 - output 3</p> <p>4 - output 4</p>	
hdmiblackoff,y	<p>Turn off the Video black of output[y]</p> <p>0 - all outputs</p> <p>1 - output 1</p> <p>2 - output 2</p> <p>3 - output 3</p> <p>4 - output 4</p>	hdmiblackoff,1 ok
gethdmisync	<p>Query output HDMI Sync feature status.</p>	<p>hdmisyncon,1!</p> <p>hdmisyncon,2!</p> <p>hdmisyncoff,3!</p> <p>hdmisyncoff,2!</p>
hdbtpoweron:x	<p>x is the input or output hdbaseT</p> <p>x = 0 - 4</p> <p>0 - all HDBT ports</p> <p>1 - HDBT input 1</p> <p>2 - HDBT input 2</p> <p>3 - HDBT output 1</p> <p>4 - HDBT output 2</p>	hdbtpoweron:1 ok
hdbtpoweroff:x	<p>x is the input or output hdbaseT</p> <p>x = 0 - 4</p> <p>0 - all HDBT ports</p> <p>1 - HDBT input 1</p> <p>2 - HDBT input 2</p> <p>3 - HDBT output 1</p> <p>4 - HDBT output 2</p>	hdbtpoweroff:1 ok
gethdbtpower	<p>Query status on HDBT power on</p>	<p>hdbtpoweron:1!</p> <p>hdbtpoweron:2!</p>

6x4+2 4K@60 4:4:4 Matrix Switcher w/ Audio Matrix

		hdbtpoweroff:3! hdbtpoweron:4!
rs232mode:z	Set the RS232 local port mode. z = 1-4 1 - Local control 2 - TX <-> RX 3 - TX <-> Matrix 4 - RX <-> Matrix	rs232mode:1 ok
getrs232mode	Query the local RS232 port mode	rs232mode:1!
remotecontroliron:y	Enable the ability to control the Tight from a receiver IR y = 0 – 4 0 - all HDBT ports 1 - HDBT input 1 2 - HDBT input 2 3 - HDBT output 1 4 - HDBT output 2	remotecontroliron:y ok
remotecontroliroff:y	Disable the ability to control the Tight from a receiver IR y = 0 – 4 0 - all HDBT ports 1 - HDBT input 1 2 - HDBT input 2 3 - HDBT output 1 4 - HDBT output 2	remotecontroliroff:y ok
getremotecontrolir	Query which receiver(s) have the ability to control the Tight using the receivers ir port	remotecontroliron:1 ok! remotecontroliron:2 ok! remotecontroliron:3 ok! remotecontroliron:4 ok!
setoutputpriority,y:zz	Sets the priority for EDID and HDCP between HDMI and HDBToutputs 1 and	setoutputpriority,2:ET ok

6x4+2 4K@60 4:4:4 Matrix Switcher w/ Audio Matrix

	<p>2</p> <p>y= 1-2</p> <p>1 - output 1</p> <p>2 - output 2</p> <p>zz = "ET" Default HDBT priority(EDID, HDCP)</p> <p>zz = "EH" Default HDMI priority(EDID, HDCP)</p>	
getoutputpriority	Query output priority status for output 1 and 2	outputpriority,1:ET! outputpriority,2:EH!
<p>cec<i>n,x,[bb],[cc]:[dd]</i></p> <p>cec<i>out,y,[bb],[cc]:[dd]</i></p> <p>Example:</p> <p>cec<i>out,1,40,44:43</i></p> <p>cec<i>n,4,04,44:01</i></p>	<p>cec<i>n</i> is the command to send cec to an input port</p> <p>cec<i>out</i> is the commands to send cec to an output port</p> <p>bb, cc, dd are all hexadecimal data;</p> <p>x represents the input port, the input is 1-6,</p> <p>y represents the output port, the input is 1-4,</p> <p>FF represents all;</p> <p>bb: Represents device type (TV :40,20,80, Disc player 04,08, etc.);</p> <p>Example:</p> <pre>#define CEC_ALL_DEVICE_TYPES_TV (0x80) #define CEC_ALL_DEVICE_TYPES_RECORDING_DEVICE (0x40) #define CEC_ALL_DEVICE_TYPES_TUNER (0x20) #define</pre>	<p>cec<i>n,x,[bb],[cc]:[dd]</i> ok</p> <p>cec<i>out,y,[bb],[cc]:[dd]</i> ok</p> <p>Example:</p> <p>cec<i>out,1,40,44:43</i></p> <p>cec<i>n,4,04,44:01</i></p>

6x4+2 4K@60 4:4:4 Matrix Switcher w/ Audio Matrix

	<pre> CEC_ALL_DEVICE_TYPES_PLAYBACK_DEVICE (0x10) #define CEC_ALL_DEVICE_TYPES_AUDIO_SYSTEM (0x08) #define CEC_ALL_DEVICE_TYPES_CEC_SWITCH (0x04) cc: Represents CEC function category (e.g. 44 for remote function) eActiveSource =0x82, // follower:TV, switch --> Broadcast , Directly address elImageViewOn =0x04, // follower:TV, switch --> Broadcast eTextViewOn =0x0D, // follower:TV eStandBy =0x36, // follower:All --> Broadcast eUserControlPressed =0x44, // follower:All --> Broadcast//User control, equivalent to remote control dd: represents the specific data under the function (for example, 41, represents the volume of the remote control code plus). This can send two or three groups of combined data, or it can not send up to 9 groups according to the instructions. (See section 8.3.7 CEC Table for CEC codes.) </pre>	
<p>sendusercommand,z</p>	<p>Sends the User Defined Commands that is defined in WEB UI.</p> <p>z = 1 - 3</p>	<p>sendusercommand,z ok</p>

6x4+2 4K@60 4:4:4 Matrix Switcher w/ Audio Matrix

	<p>1 - User Defined Command 1 2 - User Defined Command 2 3 - User Defined Command 3</p>	
<p>sendascii,y,x:zzz (ZZZ supports up to 43 characters)</p>	<p>Send the ascii command zzz on the local RS232 port or remote HDBT port using the specified baud rate [x]</p> <p>x = 1 - 7</p> <p>1 - 2400 2 - 4800 3 - 9600 4 - 19200 5 - 38400 6 - 57600 7 - 115200</p> <p>y = 0 - 5, output port</p> <p>0 - all output ports 1 - HDBT input 1 2 - HDBT input 2 3 - HDBT output 1 4 - HDBT output 2 5 - Local port</p> <p>zzz = ascii command</p>	
<p>sendhex,y,x:zzz (zzz supports up to 43 characters)</p>	<p>Send the hex command zzz on the local RS232 port or remote HDBT port using the specified baud rate [x]</p> <p>x = 1 - 7</p> <p>1 - 2400 2 - 4800 3 - 9600 4 - 19200</p>	

6x4+2 4K@60 4:4:4 Matrix Switcher w/ Audio Matrix

	<p>5 - 38400 6 - 57600 7 - 115200</p> <p>y = 0 - 5, output port 0 - all output ports 1 - HDBT input 1 2 - HDBT input 2 3 - HDBT output 1 4 - HDBT output 2 5 - Local port</p> <p>zzz = hex command</p>	
<p>sendasciipowon,y,x:zz z (zzz supports up to 48 characters)</p>	<p>Send the ascii command zzz on the local RS232 port or remote HDBT port using the specified baud rate [x] when unit is entering poweron status</p> <p>x = 1 - 7 1 - 2400 2 - 4800 3 - 9600 4 - 19200 5 - 38400 6 - 57600 7 - 115200</p> <p>y = 0 - 5, output port 0 - all output ports 1 - HDBT input 1 2 - HDBT input 2 3 - HDBT output 1</p>	<p>sendasciipowon,y,x:zzz ok</p>

6x4+2 4K@60 4:4:4 Matrix Switcher w/ Audio Matrix

	<p>4 - HDBT output 2</p> <p>5 - Local port</p> <p>zzz = ascii command</p>	
<p>sendhexpowon,y,x:zzz (zzz supports up to 48 characters)</p>	<p>Set the hexcommand zzz on the local RS232 port or remote HDBT port using the specified baud rate [x] when unit is entering poweron status</p> <p>x = 1 - 7</p> <p>1 - 2400</p> <p>2 - 4800</p> <p>3 - 9600</p> <p>4 - 19200</p> <p>5 - 38400</p> <p>6 - 57600</p> <p>7 - 115200</p> <p>y = 0 - 5, output port</p> <p>0 - all output ports</p> <p>1 - HDBT input 1</p> <p>2 - HDBT input 2</p> <p>3 - HDBT output 1</p> <p>4 - HDBT output 2</p> <p>5 - Local port</p> <p>zzz = hex command</p>	<p>sendhexpowon,y,x:zzz ok</p>
<p>sendhexpowoff,y,x:zzz (zzz supports up to 48 characters)</p>	<p>Set the hex command zzz on the local RS232 port or remote HDBT port using the specified baud rate [x] when unit is entering poweroff status</p> <p>x = 1 - 7</p> <p>1 - 2400</p>	<p>sendhexpowoff,y,x:zzz ok</p>

6x4+2 4K@60 4:4:4 Matrix Switcher w/ Audio Matrix

	<p>2 - 4800</p> <p>3 - 9600</p> <p>4 - 19200</p> <p>5 - 38400</p> <p>6 - 57600</p> <p>7 - 115200</p> <p>y = 0 - 5, output port</p> <p>0 - all output ports</p> <p>1 - HDBT input 1</p> <p>2 - HDBT input 2</p> <p>3 - HDBT output 1</p> <p>4 - HDBT output 2</p> <p>5 - Local port</p> <p>zzz = hex command</p>	
gethdcpinputs	<p>Example Query the HDCP status of all input ports</p>	<p>in 1 hdcpoff!</p> <p>in 2 hdcpoff!</p> <p>in 3 hdcpoff!</p> <p>in 4 hdcpoff!</p> <p>in 5 hdcpoff!</p> <p>in 6 hdcpoff!</p>

8.3.7 CEC Table

CEC Function	Command
CEC_RC_SELECT	00
CEC_RC_UP	01
CEC_RC_DOWN	02
CEC_RC_LEFT	03
CEC_RC_RIGHT	04
CEC_RC_RIGHT_UP	05

6x4+2 4K@60 4:4:4 Matrix Switcher w/ Audio Matrix

CEC_RC_RIGHT_DOWN	06
CEC_RC_LEFT_UP	07
CEC_RC_LEFT_DOWN	08
CEC_RC_ROOT_MENU	09
CEC_RC_SETUP_MENU	0A
CEC_RC_CONTENTS_MENU	0B
CEC_RC_FAVORITE_MENU	0C
CEC_RC_EXIT	0D
//	0E - 1F Reserved
CEC_RC_0	20
CEC_RC_1	21
CEC_RC_2	22
CEC_RC_3	23
CEC_RC_4	24
CEC_RC_5	25
CEC_RC_6	26
CEC_RC_7	27
CEC_RC_8	28
CEC_RC_9	29
CEC_RC_DOT	2A
CEC_RC_ENTER	2B
CEC_RC_CLEAR	2C
//	2D - 2F Reserved
CEC_RC_CHANNEL_UP	30
CEC_RC_CHANNEL_DOWN	31
CEC_RC_PREVIOUS_CHANNEL	32
CEC_RC_SOUND_SELECT	33
CEC_RC_INPUT_SELECT	34
CEC_RC_DISPLAY_INFORMATION	35
CEC_RC_HELP	36
CEC_RC_PAGE_UP	37
CEC_RC_PAGE_DOWN	38
//	39 - 3F Reserved

6x4+2 4K@60 4:4:4 Matrix Switcher w/ Audio Matrix

CEC_RC_POWER	40
CEC_RC_VOLUME_UP	41
CEC_RC_VOLUME_DOWN	42
CEC_RC_MUTE	43
CEC_RC_PLAY	44
CEC_RC_STOP	45
CEC_RC_PAUSE	46
CEC_RC_RECORD	47
CEC_RC_REWIND	48
CEC_RC_FAST_FORWARD	49
CEC_RC_EJECT	4A
CEC_RC_FORWARD	4B
CEC_RC_BACKWARD	4C
CEC_RC_STOP_RECORD	4D
CEC_RC_PAUSE_RECORD	4E
//	4F Reserved
CEC_RC_ANGLE	50
CEC_RC_SUB_PICTURE	51
CEC_RC_VIDEO_ON_DEMAND	52
CEC_RC_ELECTRONIC_PROGRAM_GUIDE	53
CEC_RC_TIMER_PGRMING	54
CEC_RC_INITIAL_CONFIGURATION	55
CEC_RC_SELECT_BROADCAST_TYPE	56
CEC_RC_SELECT_SOUND_PRESENTATION	57
//	58 - 5F Reserved
CEC_RC_PLAY_FUNCTION	60
CEC_RC_PAUSE_PLAY_FUNCTION	61
CEC_RC_RECORD_FUNCTION	62
CEC_RC_PAUSE_RECORD_FUNCTION	63
CEC_RC_STOP_FUNCTION	64
CEC_RC_MUTE_FUNCTION	65
CEC_RC_RESTORE_VOLUME_FUNCTION	66
CEC_RC_TUNE_FUNCTION	67

6x4+2 4K@60 4:4:4 Matrix Switcher w/ Audio Matrix

CEC_RC_SELECT_DISK_FUNCTION	68
CEC_RC_SELECT_AV_INPUT_FUNCTION	69
CEC_RC_SELECT_AUDIO_INPUT_FUNCTION	6A
CEC_RC_POWER_TOGGLE_FUNCTION	6B
CEC_RC_POWER_OFF_FUNCTION	6C

9. Firmware Upgrade

9.1 MCU upgrade by USB

Please follow the steps as below to upgrade firmware by the FW port on the front panel:

- 1) Prepare the latest upgrade file (**.APP**) and rename it as “**08010000.APP**” on PC.
- 2) Power off the switcher and connect the **FW** port of switcher to the PC with USB cable.
- 3) Power on the switcher, and then the PC will automatically detect a U-disk named “**BOOTDISK**”.
- 4) Double-click the U-disk, a file named “**READY.TXT**” would be shown.
- 5) Directly copy the latest upgrade file (**.APP**) to the “**BOOTDISK**” U-disk.
- 6) Reopen the U-disk to check that the filename “**READY.TXT**” automatically becomes “**SUCCESS.TXT**”, if yes, the firmware has been updated successfully. If the firmware updating fails, please check the name of upgrade file (**.APP**) and then follow the above steps to update again.
- 7) Remove the USB cable after firmware upgrade.
- 8) After firmware upgrade, the switcher should be restored to factory default by sending corresponding command.

9.2 MCU upgrade by Web UI



The screenshot shows the 'Device Settings' page with the following information and controls:

Model Name:	MSW-H614A-HDBT	Firmware Update:	<input type="text" value="E:\"/>	<input type="button" value="Browse"/>	<input type="button" value="Update"/>
MAC Address:	00-00-00-00-00	Factory Reset:	<input type="button" value="Factory Reset"/>		
Serial Number:	000000000000	Reboot Unit:	<input type="button" value="Browse"/>		
Firmware Version:	V1.00				

- 1) Open the Web UI as described in section **6. GUI Control** and navigate to the tab **Device Settings**.
- 2) Click on **Browse** and select the MCU firmware file.
- 3) Click Update.
- 4) After firmware upgrade, the switcher should be restored to factory default by clicking **Factory Reset**

9.3 GUI Upgrade

Please visit web server at the device IP-address and port number 100 for GUI online upgrade. Example using the default IP-address: <http://192.168.0.178:100>.

Type the username and password (the same as the GUI log-in, modified password will be available only after rebooting) to login the configuration interface. After that, click **Administration** in the source menu, and then click **Upload Firmware**, select the desired update file and press **Apply**, it will start the upgrading process.

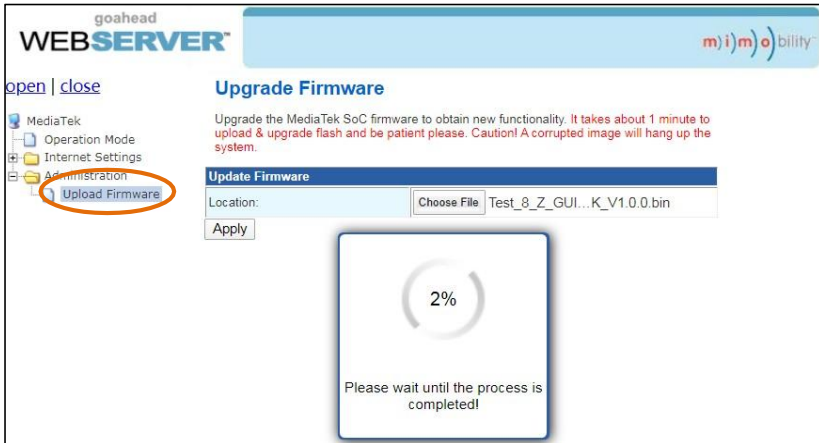

10. Drawings and Dimensions

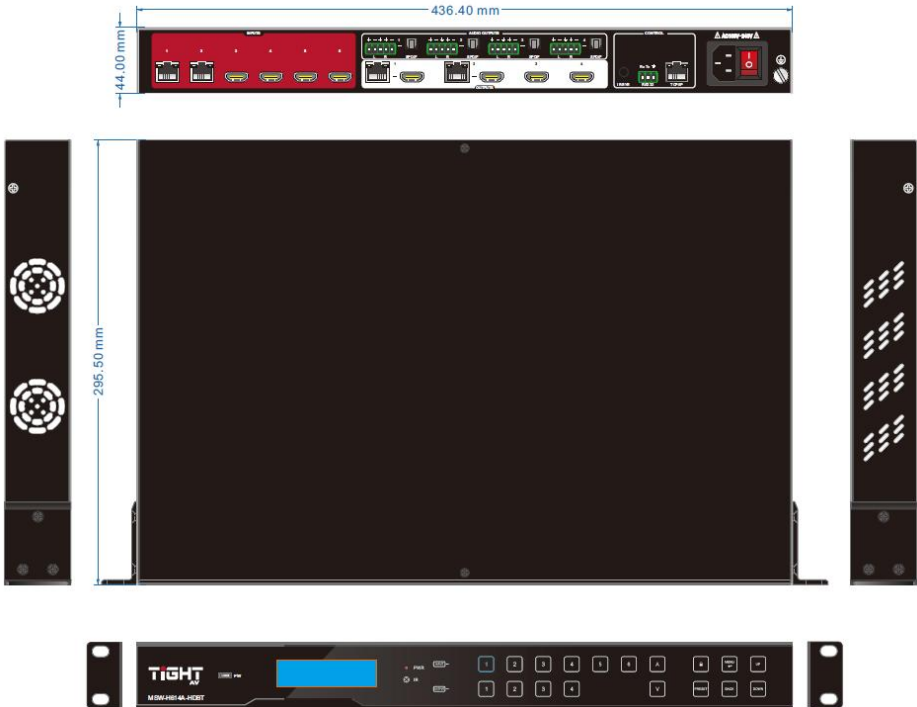





11. Environment and recycling information



11.1 Disposal of electric and electronic devices EC Directive 2012/19/EU

This product is not to be treated as regular household waste but must be returned to a collection point for recycling electric and electronic devices. Further information is available from your municipality, your municipality's waste disposal services, or the retailer where you purchased your product.

11.2 Packaging recycling information

	SCATOLA CORRUGATED PAPER BOX	RACCOLTA CARTA MIXED PAPER AND CARD
	BUSTA PER DEVICE DEVICE BAG	RACCOLTA PLASTICA PLASTICS
	PIATTINA ANIMATA CABLE TIE	RACCOLTA CARTA MIXED PAPER AND CARD
	SCHIUMA EPE PACKING FOAM	RACCOLTA PLASTICA PLASTICS
	BUSTA PER ACCESSORI ACCESSORIES BAG	RACCOLTA CARTA MIXED PAPER AND CARD

*Verifica le disposizioni del tuo comune Check
the regulations of your municipality*

Note: This manual is recycled as paper (mixed paper and card).

